

REVISIONS					
REV	ECO	DESCRIPTION	DATE	BY	APPR
A1	--	RELEASED	16MAR2020	J. HEAD	DH

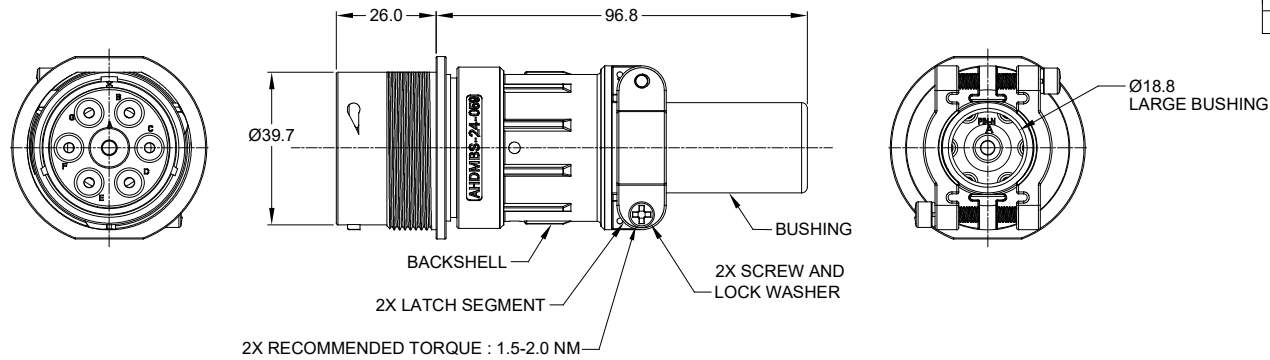

NOTES: UNLESS OTHERWISE SPECIFIED

- RECEPTACLE MATERIAL:
SHELL: ZINC ALLOY, NICKEL PLATED
INSERT AND RETAINING RING: THERMOPLASTIC
SEAL: SILICONE RUBBER
- BACKSHELL MATERIAL:
SHELL: ALUMINIUM ALLOY, NICKEL PLATED;
LATCH SEGMENT: ALUMINIUM ALLOY, NICKEL PLATED;
SCREW AND LOCK WASHER: STAINLESS STEEL;
BUSHING: EPDM.
- SPECIFICATIONS:
3.1 OPERATING TEMPERATURE: -55°C TO +125°C.
3.2 DIELECTRIC WITHSTANDING VOLTAGE: LESS THAN 2 MILLIAMPS CURRENT LEAKAGE @ 1500 VOLTS AC.
3.3 INSULATION RESISTANCE: 1000 MEGOHM MIN @ 25°C.
3.4 MOISTURE RESISTANCE: IP67 & IP69K (MATED CONDITION).
3.5 MATING CYCLE DURABILITY: 100 CYCLES
3.6 RoHS COMPLIANT
- APPLY TO CABLE OD SIZE: $\varnothing 11.20$ - $\varnothing 24.08$. CAN BE USED:
4.1. WITH LARGE AND SMALL BUSHINGS IN PLACE.
4.2. WITH ONLY LARGE BUSHING IN PLACE.
4.3. WITH BOTH BUSHINGS REMOVED.
- ALL DIMENSIONS ARE FOR REFERENCE USE ONLY.
- SEE SPECIFIC RECEPTACLE DRAWING FOR:
6.1 CONTACT SIZE AND WIRE RANGE.
6.2 RETAINING RING COLOR.
6.3 MATING PART(S).
6.4 CONTACT LAYOUT AND ALL OTHER SPECIFICATIONS.

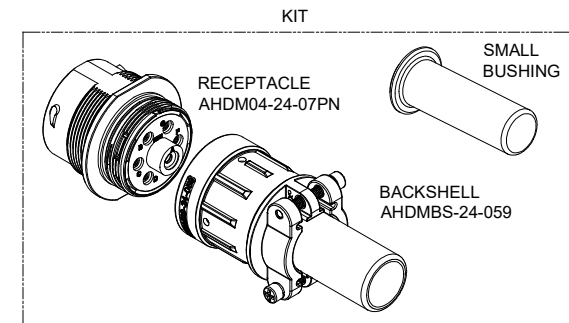
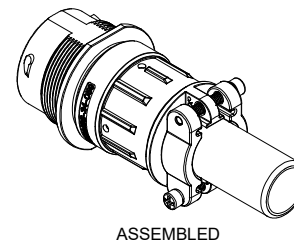

AHDMM04-24-07PN-059		HDM04-24-07PN-059	
QUANTITY	PART NUMBER	DESCRIPTION	
		ITEM	
MATERIALS LIST			
UNLESS OTHERWISE SPECIFIED 1) All dimensions are in metric (mm). 2) Tolerances are as follows: 1 PL DEC ± 0.30 2 PL DEC ± 0.15 3 PL DEC ± 0.08 3) Note reference = Fractions $\pm 1/64$ Angles $\pm 1^\circ$		SIGNATURES DATE DRAWN: J. HEAD 16MAR2020 CHECKED: ENGINEER: APPROVAL: MATERIAL SPECIFICATIONS: PROCESS SPECIFICATIONS: NEXT ASSY:	
		Amphenol Sine Systems - www.amphenol-sine.com 44724 Morley Drive Clinton Township, MI 48036 DURAMATE AHDM RECEPT, SIZE 24, WD THD, KIT W/ CABLE CLAMP BACKSHELL	
		SIZE: B C- TYPE: C- SCALE: NONE	DWG NO: AHDMM04-24-07PN-059 REVISION: A1 SHEET 1 OF 1

TITLE: KIT RECEPT AND BACKSHELL SZ 24
 DWG NO: AHDMM04-24-07PN-059
 REV: A1
 SH: 1
 OF: 1

MagnaMate™ ATHP - DuraMate™ AHDP - DuraMate™ AHDM Series - Contact Size 12 Options



Machined Contacts, Sockets & Pins				
Part Number	Description	Size	AWG	Type
AT60-204-12141-10	Male Contact - Pin, Nickel-plated	12	10-12	Machined
AT62-203-12141-10	Female Contact - Socket, Nickel-plated	12	10-12	Machined
AT60-220-1231	Male Contact - Pin, Gold-plated	12	12-14	Machined
AT62-210-1231	Female Contact - Socket, Gold-plated	12	12-14	Machined
AT60-204-12141	Male Contact - Pin, Nickel-plated	12	12-14	Machined
AT62-203-12141	Female Contact - Socket, Nickel-plated	12	12-14	Machined

DiagnosticGrade™ Machined Contacts, Sockets & Pins				
• Smaller AWG for Diagnostic Applications • Gold-plated • Increased Mating Cycles • Cost-effective				
Part Number	Description	Size	AWG	Type
65-54749	Male Contact - DiagnosticGrade™, Pin, Gold-plated	12	20	Machined
AT62-210-1231-1820	Female Contact - DiagnosticGrade™, Socket, Gold-plated	12	20	Machined

Tooling - Machined Contacts		
Part	Part Number	Description
	CA-5D12	Universal Hand Crimp Tool, Size 12/16/20 (Machined contacts only)
	CA-5E12	Pneumatic Crimp Tool, Size 12/16/20 (Machined contacts only)

Contact Removal Tools		
Part	Part Number	Description
	AT11-337-1205	Contact Removal Tool, Plastic, Size 12
	A114017	Sealing Plug, Size 12, White





Stamped & Formed Contacts, Sockets & Pins				
Part Number	Description	Size	AWG	Type
AT60-12-0244	Male Contact - Pin, Gold-plated	12	10-12	Stamped & Formed
AT62-12-0244	Female Contact - Socket, Gold-plated	12	10-12	Stamped & Formed
AT60-12-0222	Male Contact - Pin, Nickel-plated	12	10-12	Stamped & Formed
AT62-12-0222	Female Contact - Socket, Nickel-plated	12	10-12	Stamped & Formed
AT60-12-0144	Male Contact - Pin, Gold-plated	12	12-14	Stamped & Formed
AT62-12-0144	Female Contact - Socket, Gold-plated	12	12-14	Stamped & Formed
AT60-12-0166	Male Contact - Pin, Nickel-plated	12	12-14	Stamped & Formed
AT62-12-0166	Female Contact - Socket, Nickel-plated	12	12-14	Stamped & Formed

Tooling - Stamped & Formed Contacts		
Part	Part Number	Description
	MFX-3973	Crimp Die - Size 12 (S&F contacts only)
	MFX-3985	Crimp Die - Size 12 (S&F contacts only) 10-12AWG -02XX Series
	ATT-12-00	Hand Crimp Tool - Size 12, 12AWG (S&F contacts only)
	ATT-12-01	Hand Crimp Tool - Size 12, 10AWG (S&F contacts only)

Amphenol Sine Systems
 44724 Morley Drive
 Clinton Township, MI 48036 USA
www.amphenol-sine.com
 01/2022

DuraMate™ ATHD Series™ - Contact Size 8 Options

Machined Contacts, Pins and Sockets					
Part Number	Description	Size	AWG	Type	Amps
AT60-204-08141	Male Contact - Pin, Copper Alloy, Nickel-Plated	8	8-10	Machined	60A
AT62-203-08141	Female Contact - Socket, Copper Alloy, Nickel-Plated	8	8-10	Machined	60A

Tooling - Machined Contacts		
Part	Part Number	Description
	WA23	Heavy Duty Pneumatic Crimp Tool -Uses Universal Positioner Part No. WA23-101DA and Crimp Locator MFX-3961
	WA23-2	Die Assembly -for CA-5E12 Heavy Duty Pneumatic Crimp Tool, Size 8
	WA23-10	Contact Locator, Size 8
	96-978-22	Crimper and Dies -for Size 10mm ² -185mm ² Wires

Contact Removal Tools		
Part	Part Number	Description
	AT114008	Contact Removal Tool, Plastic, Size 8, 8-10AWG