

7A_{RMS} VBUS Current-Sink Protection Load Switch

Features

- 3V to 23V Operating Voltage Range
- 29V Abs. Max. Rating at IN and OUT
- 7A Continuous Current Rating
 - ▶ 15A Pulse Current Rating (duration Pd limited)
- 11mΩ typ. On-Resistance from IN to OUT
- Soft-Start (SS) Limits Inrush Current
- Over-Voltage Protection (OVP) at IN
 - ▶ 23V Internally Fixed
 - ▶ 4V to 23V External Resistor Programmable
- “Ideal Diode” Reverse-Current Protection (RCP)
 - ▶ RCP Fast Recovery without Fault Indication
- Short-Circuit Protection (SCP) at OUT
- Over-Current Protection (OCP)
- Over-Temperature Protection (OTP)
- Transient Voltage Suppression (TVS) at IN
 - ▶ ±90V Surge Protection (IEC61000-4-5)
 - ▶ ±8kV ESD Contact Discharge (IEC61000-4-2)
 - ▶ ±15kV ESD Air Gap Discharge (IEC61000-4-2)
- $\overline{\text{EN}}$ Active-Low Enable Logic Input
- Auto-Retry after All Faults
- $\overline{\text{ACOK}}$ Open-Drain Output Flag
- -40°C to 85°C Operating Temperature Range
- 25-bump WLCSP 2.70 x 2.70mm (0.5mm pitch)

Brief Description

The KTS1697A is a low-resistance, high-current load switch with soft-start, over-voltage protection, “ideal diode” reverse-current protection with fast recovery, short-circuit protection, over-current protection, over-temperature protection, and integrated TVS. It is optimized to protect systems with USB Type-C PD ports and barrel connectors that sink up to 140W at 20V and must withstand up to 29V on VBUS.

Automatic reverse-current protection acts as an “ideal diode” with fast recovery and isolates VBUS when charging or powering the system via another port, regardless of the enable status. Soft-start limits inrush current when turning on with large capacitors at the output. The integrated TVS provides IEC industry standard ESD and ±90V surge ratings.

The KTS1697A is packaged in advanced, fully “green” compliant, 2.70 x 2.70mm, 25-bump Wafer-Level Chip-Scale Package (WLCSP).

Applications

- Notebooks, Netbooks, Ultra-Books, Tablets
- Mini Desktop PCs, Docking Stations, Monitors

Typical Application

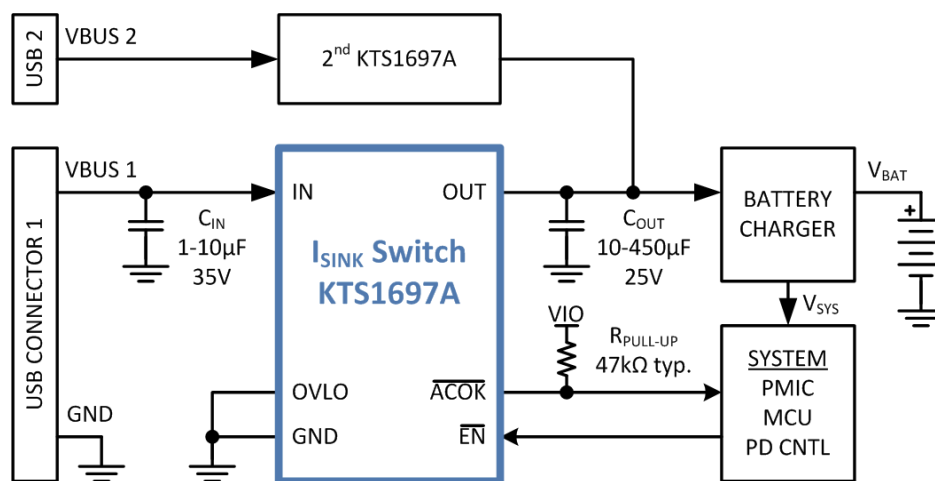

Pinout Diagram

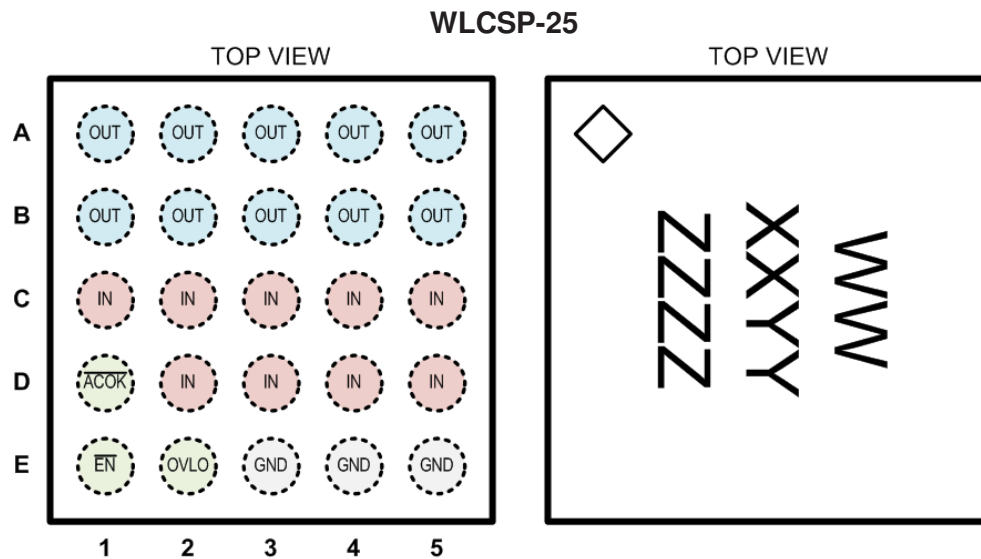

25-bump 2.70mm x 2.70mm x 0.62mm
WLCSP Package, 0.5mm pitch

Top Mark

WW = Device ID,
XX = Date Code, YY = Assembly Code,
ZZZZ = Serial Number

Pin Descriptions

Pin #	Name	Function
A1, A2, A3, A4, A5, B1, B2, B3, B4, B5	OUT	Power Switch Output – connect to battery charger input (or V _{sys} in systems without rechargeable batteries).
C1, C2, C3, C4, C5, D2, D3, D4, D5	IN	Power Switch Input – connect to power input port (VBUS on USB port).
D1	$\overline{\text{ACOK}}$	Power Good Flag – active-low, open-drain logic output
E1	$\overline{\text{EN}}$	Enable – active-low logic input with internal 1M Ω pull-down to ground
E2	OVLO	External OVLO Adjustment – connect to GND to use the internally fixed OVLO threshold. Connect an external resistive voltage divider from IN to OVLO to GND to set an adjustable the OVLO threshold.
E3, E4, E5	GND	Ground

Absolute Maximum Ratings¹

Symbol	Description	Value	Units
V _{IN}	IN to GND (continuous)	-0.3 to 29	V
	IN to GND (during IEC61000-4-5 surge event)	-5 to 36	
V _{OUT}	OUT to GND	-0.3 to 29	V
V _{IN-OUT}	IN to OUT	-29 to 29	V
V _{EN}	\overline{EN} to GND	-0.3 to 29	V
V _{OVLO}	OVLO to GND	-0.3 to V _{IN}	V
V _{ACOK}	\overline{ACOK} to GND	-0.3 to 6	V
I _{SW}	Maximum Switch Current (continuous)	7	A
	Peak Switch Current (5ms, OCP and Pd limited)	15	
T _J	Die Junction Operating Temperature Range	-40 to 150	°C
T _S	Storage Temperature Range	-55 to 150	°C
T _{LEAD}	Maximum Soldering Temperature (at leads, 10 sec)	260	°C

ESD and Surge Ratings²

Symbol	Description	Value	Units
V _{ESD_HBM}	JEDEC JS-001-2017 Human Body Model (all pins)	±2	kV
V _{ESD_CD}	IEC61000-4-2 Contact Discharge (IN)	±8	kV
V _{ESD_AGD}	IEC61000-4-2 Air Gap Discharge (IN)	±15	kV
V _{SURGE}	IEC61000-4-5 Surge (V _{IN} = 5V _{DC} +Surge, C _{IN} = 10μF, R _{LOAD} = 100Ω)	±90	V
	IEC61000-4-5 Surge (V _{IN} = 20V _{DC} +Surge, C _{IN} = 10μF, R _{LOAD} = 100Ω)	±80	

Thermal Capabilities³

Symbol	Description	Value	Units
Θ _{JA}	Thermal Resistance – Junction to Ambient	60	°C/W
P _D	Maximum Power Dissipation at T _A ≤ 25°C (T _J = 125°C)	1.67	W
ΔP _D /ΔT	Derating Factor Above T _A = 25°C	-16.7	mW/°C

- Stresses above those listed in Absolute Maximum Ratings may cause permanent damage to the device. Functional operation at conditions other than the operating conditions specified is not implied. Only one Absolute Maximum rating should be applied at any one time.
- ESD and Surge Ratings conform to JEDEC and IEC industry standards. Some pins may actually have higher performance. Surge ratings apply with chip enabled, disabled, or unpowered, unless otherwise noted.
- Junction to Ambient thermal resistance is highly dependent on PCB layout. Values are based on thermal properties of the device when soldered to an EV board.

Recommended Operating Conditions⁴

Symbol	Description	Value	Units
V _{IN}	Supply Voltage	3 to 23	V
V _{OUT}	Output Voltage	3 to 23	V
V _{ACOK}	Power Good Flag Output Voltage ⁵	0 to 5.5	V
V _{OVLO}	OVLO Adjust Input Bias Voltage	0 to 5.5	V
V _{EN}	Enable Logic Input Voltage	0 to 20	V
T _A	Ambient Operating Temperature Range	-40 to 85	°C
T _J	Die Junction Operating Temperature Range	-40 to 125	°C
C _{IN}	Input Capacitance	1 to 10	μF
C _{OUT}	Output Capacitance	10 to 450	μF

Ordering Information

Part Number	Marking ⁶	Operating Temperature	Package
KTS1697AEOAB-TR	QYXXYYZZZZ	-40°C to +85°C	WLCSP-25

4. The recommended Operating Conditions table defines the conditions for actual device operation. Recommended operating conditions are specified to ensure optimal performance to the datasheet specifications. Kinetic does not recommend exceeding them or designing to Absolute Maximum Rating.

5. \overline{ACOK} is an open-drain output flag. Use external pull-up resistor to a suitable I/O voltage. If unused, leave floating or connect to ground.

6. QY = Device ID, XX = Date Code, YY = Assembly Code, ZZZZ = Serial Number.

Electrical Characteristics⁷

Unless otherwise noted, the *Min* and *Max* specs are applied over the full operating range of $T_A = -40^{\circ}\text{C}$ to $+85^{\circ}\text{C}$ and $V_{IN} = 3\text{V}$ to 23V . Typical values are specified at $T_A = +25^{\circ}\text{C}$ with $V_{IN} = 5\text{V}$.

Symbol	Description	Conditions	Min	Typ	Max	Units
Supply Specifications						
V_{IN}	Input Voltage Operating Range		3		23	V
V_{UVLO}	Under-Voltage Lockout	V_{IN} rising threshold		2.7	2.9	V
		Hysteresis		150		mV
I_Q	No-Load Supply Current	Enabled, $V_{IN} = 5\text{V}$, $OUT = \text{open}$		180		μA
		Enabled, $V_{IN} = 20\text{V}$, $OUT = \text{open}$		235		
I_{SHDN}	Shutdown Supply Current	Shutdown, $V_{IN} = 5\text{V}$, $OUT = \text{open}$		1		μA
		Shutdown, $V_{IN} = 20\text{V}$, $OUT = \text{open}$		3		
V_{OUT}	Output Voltage Operating Range		3		23	V
I_{OUT_RCP}	Output Supply Current in RCP	Enabled, $V_{IN} = 0\text{V}$, $V_{OUT} = 5\text{V}$		300		μA
Transient Voltage Suppression (TVS) Specifications						
V_{TVS}	TVS Clamp Voltage			32.5		V
Logic Pin Specifications						
V_{IH}	Input Logic High (\overline{EN})		1.2			V
V_{IL}	Input Logic Low (\overline{EN})				0.4	V
$R_{\overline{EN}}$	Input Logic Pull-Down Resistance (\overline{EN})			1		$\text{M}\Omega$
V_{OL}	Output Logic Low (\overline{ACOK})	$I_{O_SINK} = 1\text{mA}$		0.01	0.2	V
I_{O_LK}	Output Logic High-Z Leakage (\overline{ACOK})	$V_O = 5\text{V}$	-1		1	μA
Switch Specifications						
R_{ON}	Switch On-Resistance	$V_{IN} = 5\text{V}$, $I_{OUT} = 1\text{A}^8$	10	20	30	$\text{m}\Omega$
		$V_{IN} = 5\text{V}$, $I_{OUT} > 2\text{A}$		11		
		$V_{IN} = 20\text{V}$, $I_{OUT} > 2\text{A}$	5	11	17	
I_{IN_OFF}	Switch Off-Leakage at IN	Shutdown, $V_{IN} = 5\text{V}$, $V_{OUT} = 0\text{V}$		1		μA
		Shutdown, $V_{IN} = 20\text{V}$, $V_{OUT} = 0\text{V}$		3		
		Shutdown, $V_{IN} = 29\text{V}$, $V_{OUT} = 0\text{V}$		4.2	10	
I_{OUT_OFF}	Switch Off-Leakage at OUT	Shutdown, $V_{IN} = 0\text{V}$, $V_{OUT} = 5\text{V}$		0.9		μA
		Shutdown, $V_{IN} = 0\text{V}$, $V_{OUT} = 20\text{V}$		3		
		Shutdown, $V_{IN} = 0\text{V}$, $V_{OUT} = 29\text{V}$		4.4	10	

(continued next page)

7. Device is guaranteed to meet performance specifications over the -40°C to $+85^{\circ}\text{C}$ operating temperature range by design, characterization, and correlation with statistical process controls.

8. When tested at 1A, the R_{ON} is limited by the V_{RCP} specification.

Electrical Characteristics (continued)⁷

Unless otherwise noted, the *Min* and *Max* specs are applied over the full operating range of $T_A = -40^{\circ}\text{C}$ to $+85^{\circ}\text{C}$ and $V_{IN} = 3\text{V}$ to 23V . Typical values are specified at $T_A = +25^{\circ}\text{C}$ with $V_{IN} = 5\text{V}$.

Symbol	Description	Conditions	Min	Typ	Max	Units
Soft-Start (SS) Specifications (see Figure 1)						
t_{DEB}	Soft-Start Debounce Time ⁹	$R_L = 100\Omega$, $C_{OUT} = 300\mu\text{F}$, $V_{IN} = 5\text{V}$	10	17	25	ms
t_R	Soft-Start V_{OUT} Rising Slew-Rate Ramp Time ¹⁰	$R_L = 100\Omega$, $C_{OUT} = 300\mu\text{F}$, $V_{IN} = 5\text{V}$	1	3	5	ms
		$R_L = 100\Omega$, $C_{OUT} = 300\mu\text{F}$, $V_{IN} = 20\text{V}$	1.8	3	4.5	
I_{LIM_SS}	Soft-Start Current Limit	$V_{IN} = 5\text{V}$ to 20V		2		A
t_{LIM_SS}	Soft-Start Current Limit Done Time	$V_{IN} = 5\text{V}$ to 20V		7		ms
t_{ACOK}	Power Good Flag Delay after t_{LIM_SS}	$V_{IN} = 5\text{V}$ to 20V		3		ms
t_{OFF}	Turn-Off Delay Time ¹¹	$V_{IN} = 5\text{V}$ to 20V	0	3	10	μs
Over-Voltage Protection (OVP) Specifications						
V_{OVP}	Internally Fixed Over-Voltage Protection	V_{IN} rising OVP threshold	22	23	25	V
		Hysteresis, $V_{OVLO} = 0\text{V}$		300		mV
t_{OVP}	OVP Response Time ¹²	$R_L = 100\Omega$, $C_{OUT} = 0\mu\text{F}$, $V_{IN} > V_{OVP}$, $V_{OVLO} = 0\text{V}$		90		ns
t_{OVP_REC}	OVP Recovery Time ¹³			$t_{DEB} + t_R$		ms
V_{OVLO}	Externally Adjustable Over-Voltage Lockout	V_{OVLO} enable threshold	0.2	0.25	0.3	V
		V_{OVLO} rising OVP threshold	1.10	1.227	1.34	V
		Hysteresis		25		mV
t_{OVLO}	OVLO Response Time ¹⁴	$R_L = 100\Omega$, $C_{OUT} = 0\mu\text{F}$		300		ns
t_{OVLO_REC}	OVLO Recovery Time			$t_{DEB} + t_R$		ms
Reverse-Current Protection (RCP) Specifications						
V_{RCP}	RCP Droop Regulation Voltage	$V_{RCP} = V_{IN} - V_{OUT}$, $I_{OUT} = 100\text{mA}$	10	20	30	mV
t_{RCP_REC}	RCP Fast Recovery Time ¹⁵			15		μs
Over-Current Protection (OCP) Specifications						
t_{OCP}	OCP Response Time ¹⁶			100		ns
t_{OCP_REC}	OCP Recovery Time			$t_{DEB} + t_R$		ms
Over-Temperature Protection (OTP) Specifications						
T_{OTP}	IC Junction Over-Temperature Protection	T_J rising threshold		150		$^{\circ}\text{C}$
		Hysteresis		20		$^{\circ}\text{C}$
t_{OTP_REC}	OTP Recovery Time			$t_{DEB} + t_R$		ms

9. t_{DEB} is time from enabled logic and $V_{UVLO} < V_{IN} < V_{OVP}$ until $V_{OUT} = 10\% \cdot V_{IN}$.

10. t_R is time from $V_{OUT} = 10\% \cdot V_{IN}$ until $V_{OUT} = 90\% \cdot V_{IN}$.

11. t_{OFF} is time from enable logic until V_{OUT} begins to fall.

12. t_{OVP} is time from $V_{IN} > V_{OVP}$ until V_{OUT} stops rising.

13. t_{OVP_REC} is time from $V_{IN} < V_{OVP}$ until $V_{OUT} = 90\% \cdot V_{IN}$.

14. t_{OVLO} is time from V_{OVLO} rises above its OVP threshold until V_{OUT} stops rising.

15. t_{RCP_REC} is time from $V_{OUT} \ll V_{IN} - 20\text{mV}$ until switch turns back on. Before measuring, first raise $V_{OUT} \gg V_{IN} + 270\text{mV}$.

16. t_{OCP} is time from $I_{OUT} \gg 20\text{A}$ until switch turns off.

Timing Diagrams

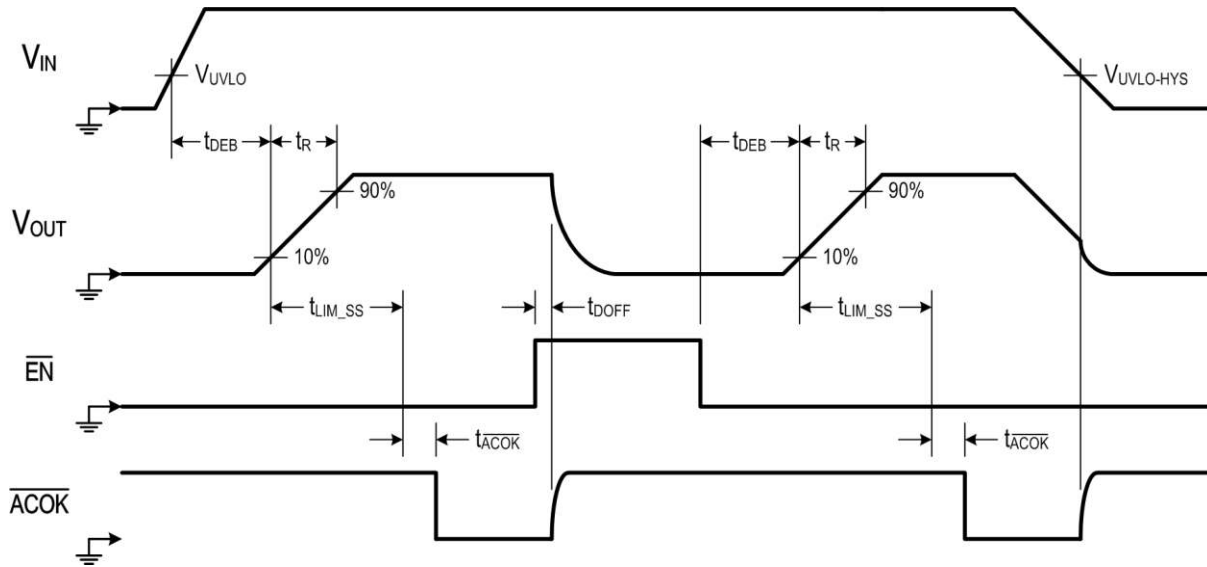

Figure 1. UVLO, Soft-Start and Turn-Off Timing Diagram

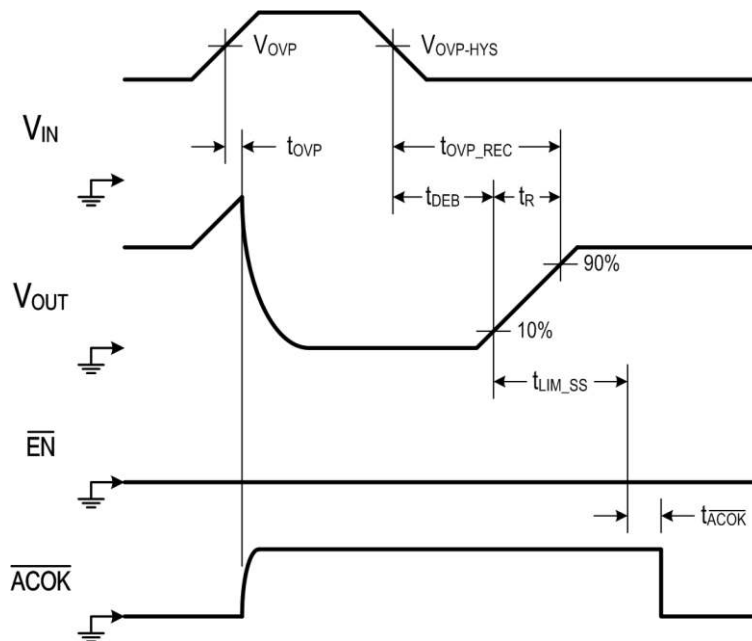

Figure 2. OVP Timing Diagram

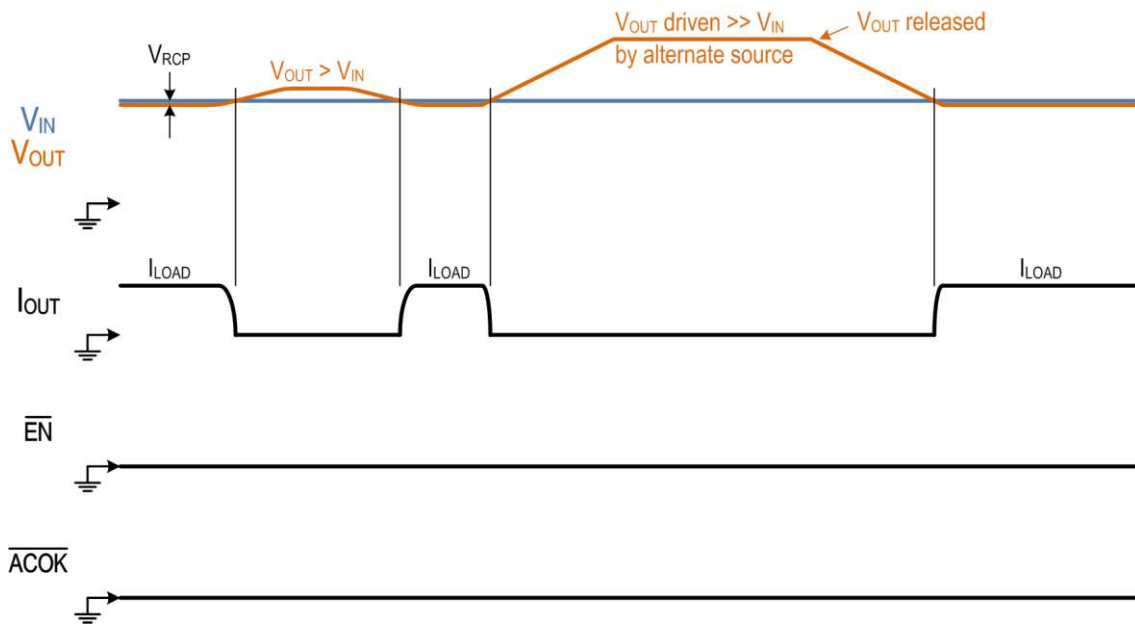

Figure 3. “Ideal Diode” RCP Timing Diagram with Fast Recovery

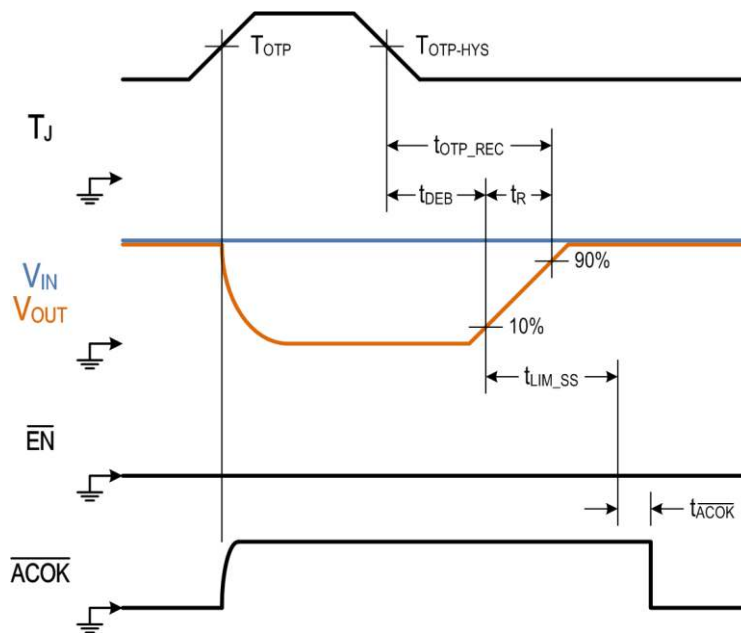

Figure 4. OTP Timing Diagram

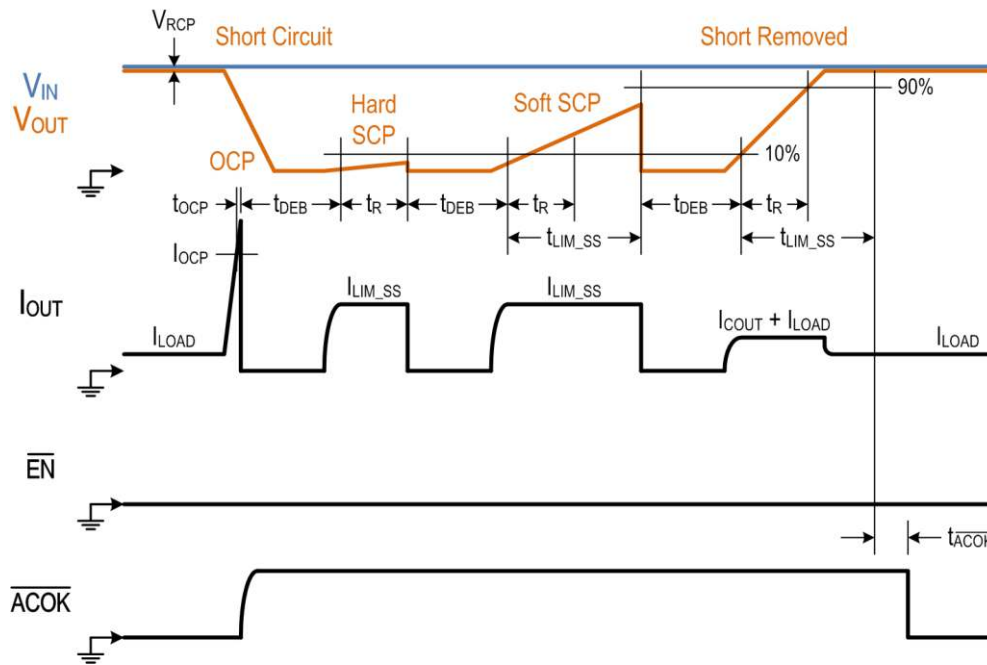
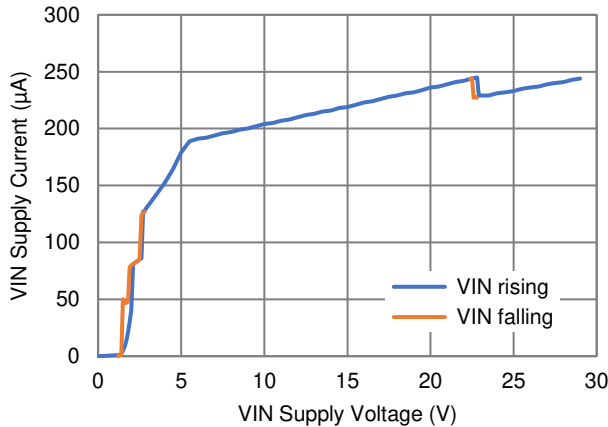

Figure 5. OCP and SCP Timing Diagram

Typical Characteristics

$C_{IN} = 10\mu F$, $C_{OUT} = 44\mu F$, Load = 100Ω , and $T_A = +25^\circ C$ unless otherwise noted.

VIN Supply Current vs. Supply Voltage
(no load, $\overline{EN} = \text{low}$)



VIN Shutdown Current vs. Supply Voltage
($\overline{EN} = \text{high}$)

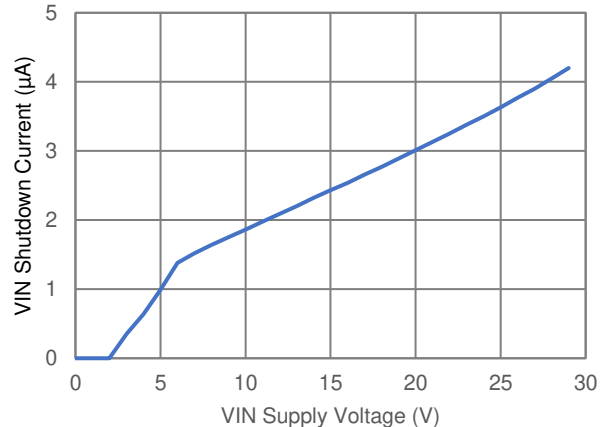

On Resistance vs. Load Current

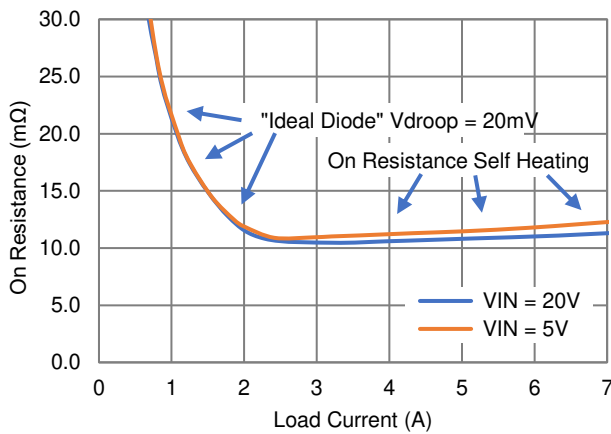

"Ideal Diode" Vdroop vs. Load Current

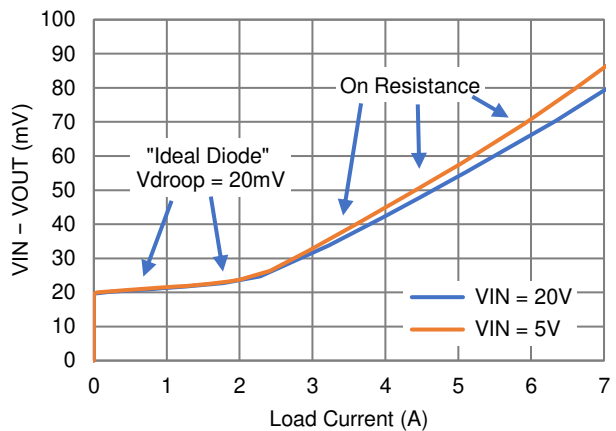

RCP Supply Current at OUT Pin
($\overline{EN} = \text{low}$)

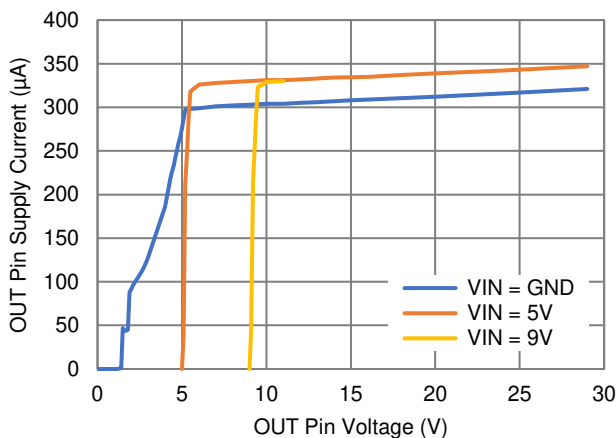

Reverse Leakage Current at OUT Pin
(VIN = GND, $\overline{EN} = \text{high}$)

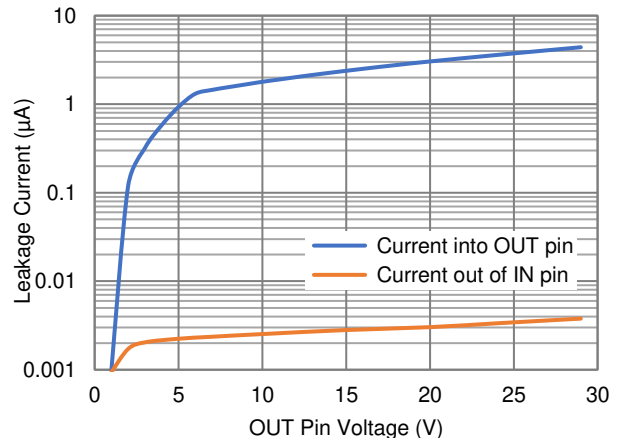

(continued next page)

Typical Characteristics (continued)

$C_{IN} = 10\mu F$, $C_{OUT} = 44\mu F$, Load = 100Ω , and $T_A = +25^\circ C$ unless otherwise noted.

Enable, Soft-Start, Shutdown Response
($V_{IN} = 20V$)

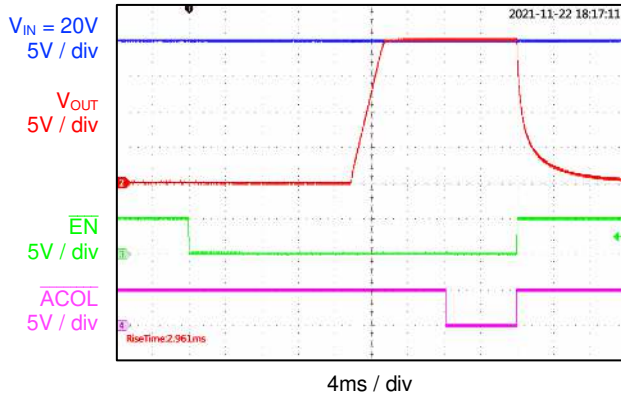

Enable, Soft-Start, Shutdown Response
($V_{IN} = 5V$)

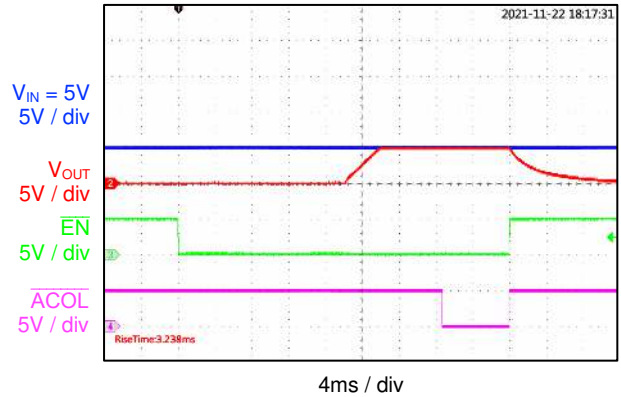

OVP Response
($V_{IN} = 15V + 28V$ Short)

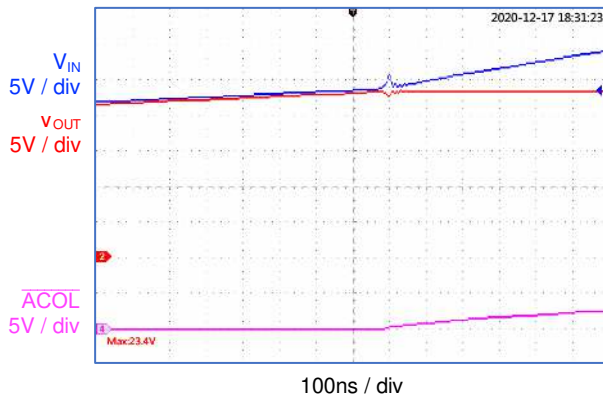

RCP Response
($V_{IN} = 5.1V$, $R_{CABLE} = 200m\Omega$, Load = 3Ω , $V_{OUT} \rightarrow 20V$)

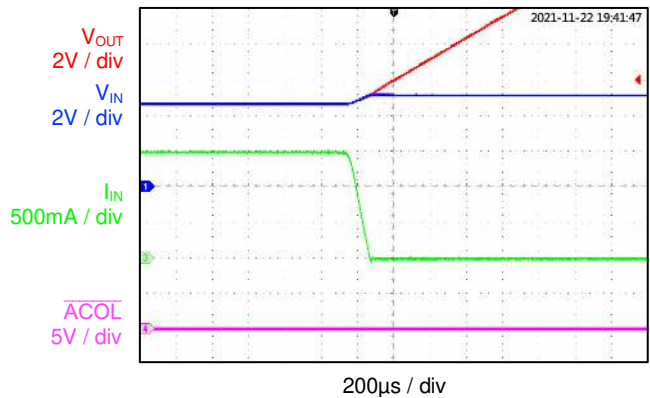

OCP Response
($V_{IN} = 20V$, $V_{OUT} = 20V \rightarrow$ Short Circuit)

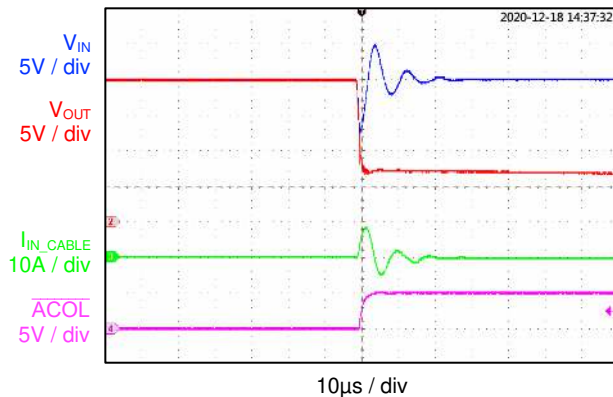

SCP Response with Auto-Retry
($V_{IN} = 20V$, $V_{OUT} = 20V \rightarrow$ Short Circuit)

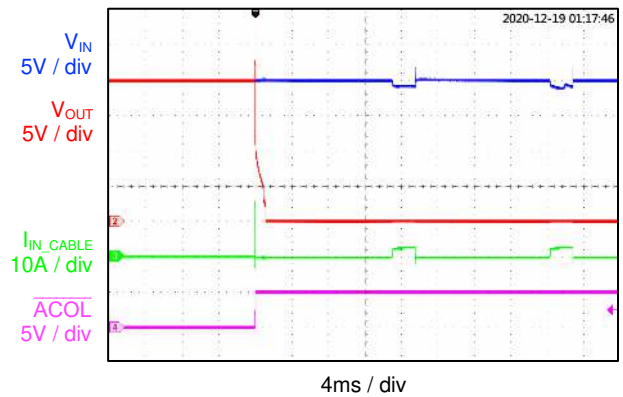

(continued next page)

Typical Characteristics (continued)

$C_{IN} = 10\mu F$, $C_{OUT} = 44\mu F$, Load = 100Ω , and $T_A = +25^\circ C$ unless otherwise noted.

Surge Transient Response
($V_{IN} = 20V_{DC} + 80V$ Surge)

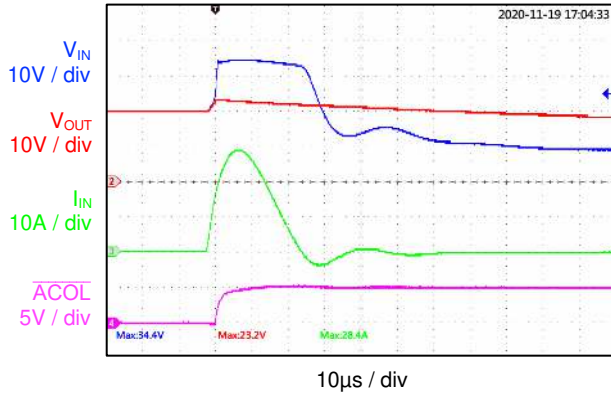

Surge Transient Response
($V_{IN} = 20V_{DC} - 80V$ Surge)

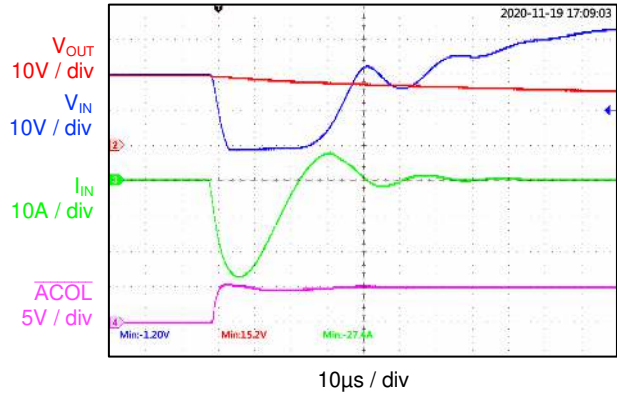

RCP Fast Recovery Response

($V_{IN} = 5.1V$, $R_{CABLE} = 200m\Omega$, Load = 3Ω , $V_{OUT} 20V \rightarrow 5V$)

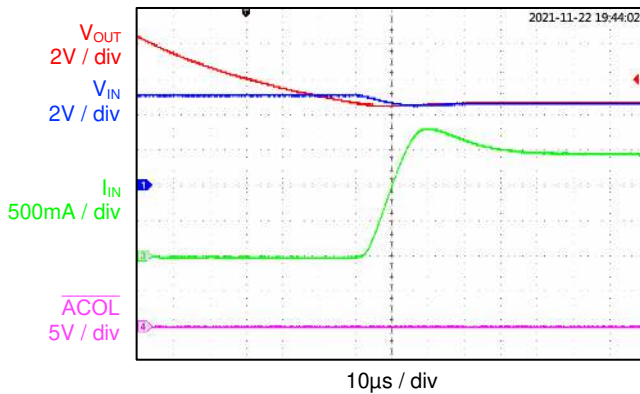

Functional Block Diagram

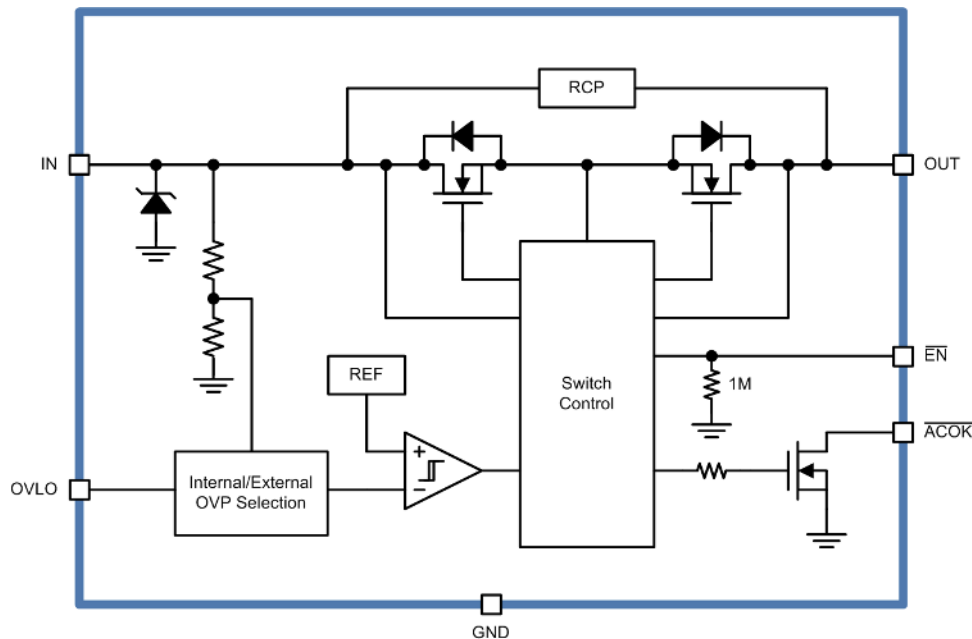

Figure 6. Functional Block Diagram

Functional Description

The KTS1697A is a slew-rate controlled, 11mΩ (typ) low resistance MOSFET switch intended to be inserted between a power source and a load to isolate and protect against abnormal voltage and current conditions. Featuring slew-rate controlled soft-start and soft-start current limit to prevent excessive large inrush current, the KTS1697A also features several additional protection functions. These include input over-voltage protection, “ideal diode” reverse-current protection with fast recovery, output short-circuit protection, over-current protection, over-temperature protection, and input transient voltage suppression for ±90V surge, ±8kV contact ESD, and ±15kV air-gap ESD protections.

Operating from a wide input voltage range of 3V to 23V, the KTS1697A is optimized for USB Type-C Power Delivery (PD) current-sink applications that require essential protection and enhanced system reliability. While in the OFF state, the KTS1697A blocks voltages of up to 29V on the IN and OUT pins and prevents current flow. While in the ON state, the KTS1697A withstands voltages of up to 29V on the IN and OUT pins, passes valid input voltages and current from IN to OUT, and blocks reverse current from OUT to IN. Due to the ideal-diode behavior, two or more KTS1697A parts can be used in parallel to support systems that may be charged or powered from multiple ports.

EN Input

The KTS1697A has \overline{EN} active-low input logic. $\overline{EN} = H$ disables the power switch and places the device into low power mode. $\overline{EN} = L$ enables the protection circuits and the power switch. A 17ms de-bounce time deploys before device turn-on and the soft-start ramp.

Under-Voltage Lockout (UVLO)

When $V_{IN} < V_{UVLO}$, the power switch is disabled. Once V_{IN} exceeds V_{UVLO} , the power switch is controlled by the enable pin and fault detection circuits.

Soft-Start (SS)

The internal soft-start function allows the KTS1697A to charge a total output capacitance of 450µF to 20V without excessive in-rush current. Soft-start controls the output voltage slew-rate ramp time. Use the below formula to calculate the current required to charge C_{OUT}:

$$I_{IN_SS} = I_{LOAD} + C_{OUT} \left(\frac{V_{IN}}{t_R} \right)$$

where t_R = 3ms. In either case, the soft-start time is somewhat fast to reduce power dissipation in the KTS1697A during soft-start.

Note that in addition to the soft-start voltage ramp, the soft-start current limit is 2A to prevent excessive heat when starting into an output short-circuit condition or a large total output capacitance. This current limit is turned off after 7ms. After an additional 3ms delay, if V_{OUT} is near V_{IN}, the \overline{ACOK} flag indicates a power good condition.

Over-Voltage Protection (OVP)

When $\overline{EN} = L$, the switch is logically enabled. However, if V_{IN} > V_{OVP}, the power switch is disabled due to an OVP fault. Once V_{IN} drops below V_{OVP}, no other fault is detected, and $\overline{EN} = L$, the power switch is re-enabled via the soft-start debounce and ramp time.

The OVLO pin is used to adjust the over-voltage threshold externally. The default internal over-voltage threshold is 23V when the OVLO pin is tied to GND. Biasing the OVLO pin with a resistive voltage divider adjusts the over voltage threshold from 4V to 23V as in the below formula:

$$V_{OVP} = V_{OVLO} \left(1 + \frac{R1}{R2} \right)$$

where V_{OVLO} = 1.227V. Connect R1 from IN to OVLO. Connect R2 from OVLO to ground.

“Ideal Diode” Reverse-Current Protection (RCP)

The KTS1697A offers reverse-current protection regardless of the enable logic level. When disabled, all current flow is blocked. When enabled, the RCP acts as a voltage droop regulator. Once the voltage on V_{OUT} is higher than V_{IN} minus 20mV, the RCP circuit reduces the MOSFET gate drive to try and maintain the regulated 20mV droop, thereby acting as an “ideal diode” with V_f = 20mV. See Figure 7. This control method blocks all reverse current. The RCP circuit makes it possible to connect two or more USB charging ports to a single charger input in a “diode-OR” configuration with autonomous reverse-current blocking. The KTS1697A includes a 15µs “fast recovery” when V_{OUT} falls back down below the “ideal diode” droop regulation point.

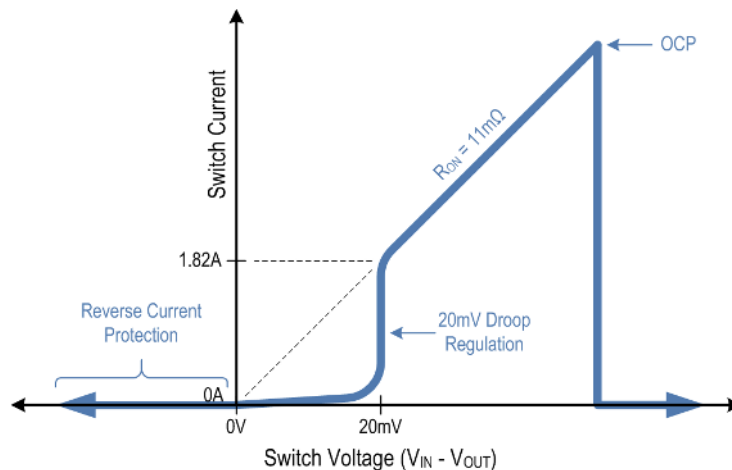

Figure 7. “Ideal Diode” Reverse-Current Protection V-I Curve

Over-Current Protection (OCP)

The KTS1697A includes output over-current protection (OCP) at 20A that protects the IC from damage when an over-current or short-circuit event suddenly appears. The OCP circuit disables the power switch, so the current becomes zero. After an OCP event, if no other fault is detected, and $\overline{EN} = L$, the power switch is re-enabled via the soft-start debounce and ramp time.

Short-Circuit Protection (SCP)

The KTS1697A includes output short-circuit protection (SCP). If an SCP event occurs while the KTS1697A is already enabled and working, OCP is the first line of defense and responds very quickly. In this case, the current from C_{IN} through the switch to C_{OUT} increases very rapidly. For SCP events that do not reach OCP, if V_{OUT} droops significantly below V_{IN} , it is also detected as a soft-short event. In case of auto-retry or simply starting into a pre-existing SCP condition, the KTS1697A furthermore includes hard and soft SCP detection during soft-start if V_{OUT} is not ramping up. The KTS1697A remains undamaged during continuous SCP events.

Over-Temperature Protection (OTP)

When device junction temperature exceeds 150°C, the OTP circuit disables the power switch. Once the device junction temperature decreases below 130°C, if no other fault is detected, and $\overline{EN} = L$, the power switch is re-enabled via the soft-start debounce and ramp time.

Transient Voltage Suppression (TVS)

The KTS1697A integrates an active clamp transient voltage suppressor (TVS) from IN to GND. The TVS circuit provides protection to the KTS1697A and downstream circuits for IEC surge and ESD events. The protection is always active, whether the KTS1697A is enabled or disabled.

Auto-Retry

For all fault conditions that cause the switch to open, the KTS1697A will auto-retry via the soft-start debounce and ramp time. If any fault or the same fault is detected again, the switch will open again, and auto-retry will repeat. This continues until the fault is removed (normal operation) or $\overline{EN} = H$ (shutdown) or V_{IN} is removed (UVLO).

\overline{ACOK} Output Flag

The \overline{ACOK} output is an open-drain output that requires an external pull-up resistor with recommended value in the 10kΩ to 200kΩ range. The \overline{ACOK} pin indicates the fault status. When there is no fault (UVLO, OVP, OCP, SCP, and OTP are not triggered) and the power switch is ON, then the \overline{ACOK} flag is pulled low to indicate the power is good. Otherwise, the \overline{ACOK} flag is high impedance. RCP is not classified as a fault condition.

Applications Information

External Component Selection

Input Capacitor C_{IN}

For most applications, connect a 1 μ F to 10 μ F ceramic capacitor as close as possible to the device from IN to GND to minimize the effect of parasitic trace inductance. 35V or 50V rated capacitors with X5R or better dielectric are recommended. For optimal surge and ESD performance, 10 μ F is preferred.

Output Capacitor C_{OUT}

For most applications, connect from 10 μ F to 450 μ F total capacitance to the output. Typical applications use 30 μ F to 100 μ F as needed for system load-transients. At minimum, connect a 10 μ F ceramic capacitor as close as possible to the device from OUT to GND to minimize the effect of parasitic trace inductance. 25V rated capacitors with X5R or better dielectric are recommended. Lower voltage ratings are acceptable when using the OVLO pin to set a lower over-voltage protection threshold.

Safe Operating Area (SOA)

The KTS1697A is a monolithic IC with integrated dual-MOSFET switch, gate-drivers, and multiple protection control circuits. The KTS1697A is specifically designed to operate within its power switch's safe operating area (SOA), as seen in Figure 8. Note that the SOA is thermally limited in Figure 8 by the die junction recommended operating temperature of $T_{J(MAX)} = 125^{\circ}C$. This is guard-banded below the Absolute Maximum Rating and Over-Temperature Protection (OTP) threshold of $T_{J(MAX)} = 150^{\circ}C$.

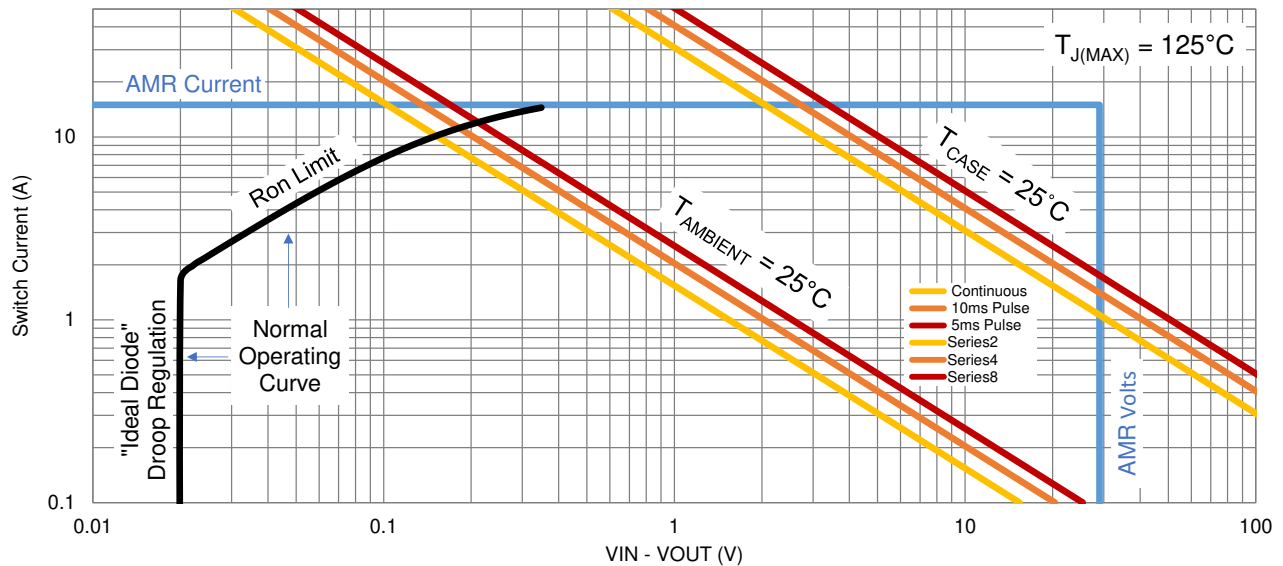

Figure 8. Safe Operating Area (SOA)

Package Power Dissipation Rating

The KTS1697A is rated for 7A continuous load current; however, it can support short load pulses at higher currents. With switch on-resistance of only 11mΩ (typ), the dissipated average power and peak power in the switch should be kept below the package power dissipation ratings, per Figure 9. To achieve this performance, good thermal PCB design is required. See the *Recommended PCB Layout* section in this datasheet.

Per bench testing using the KTS1697A EVB, in systems with active cooling to maintain a PCB temperature at $T_{PCB} = 60^{\circ}\text{C}$ maximum, the KTS1697A peak die temperature remains under $T_J < 115^{\circ}\text{C}$ with 3 sigma guard-band when loaded at 7A continuous with a 10% duty-cycle pulse (10ms pulse duration) to 10A at 10Hz (100ms) repetition rate.

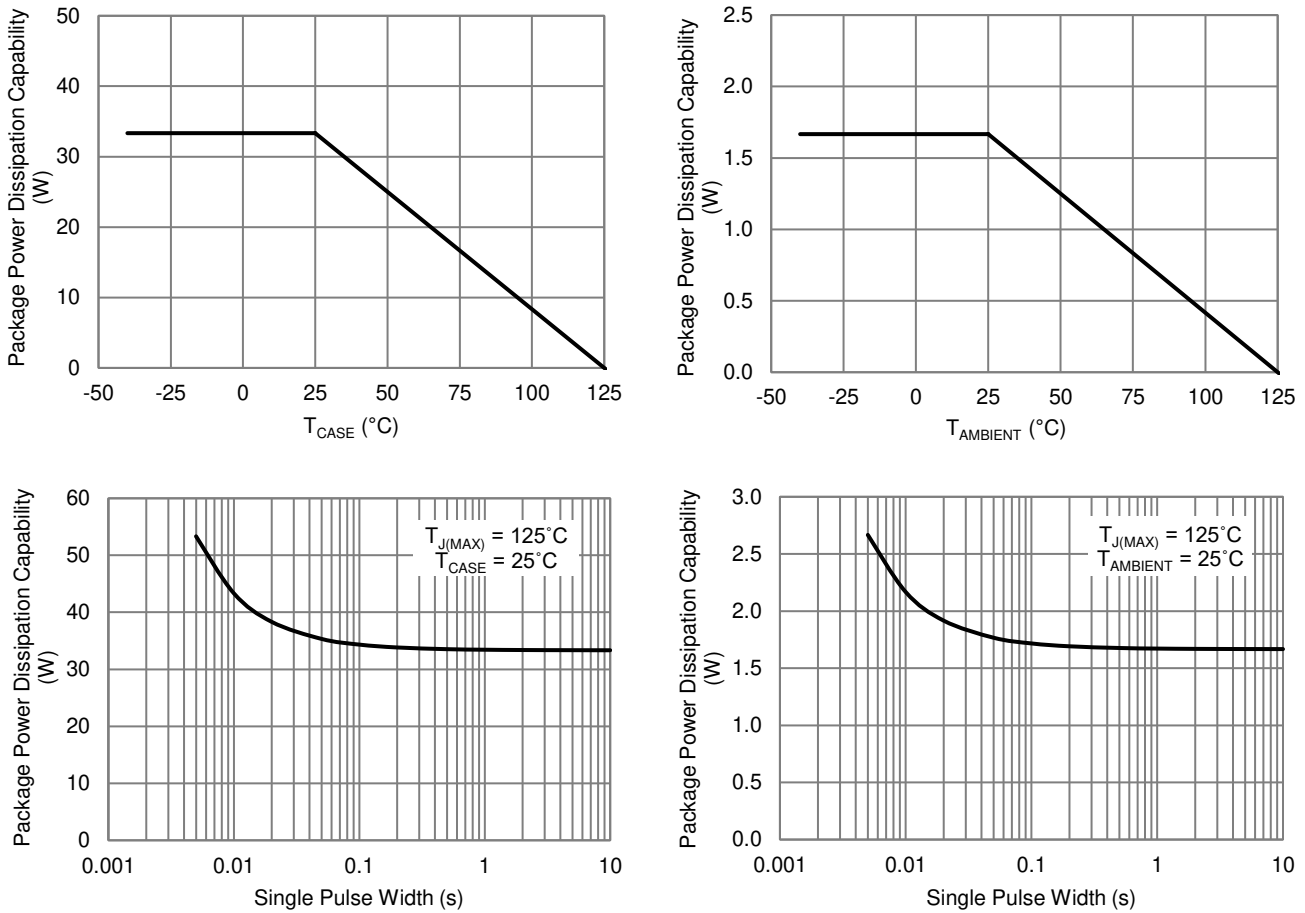

Figure 9. Package Power Dissipation Rating Curves

Recommended PCB Layout

Good PCB thermal design is required to support heavy load currents. The KTS1697A EVB is designed with similar layout as Figure 10, but it extends the fill area for the IN, OUT, and GND copper planes to about 4 square inches total area for increased thermal performance. Due to the number of bumps on IN and OUT, these two planes are especially important and should not be ignored. Adding back-side and/or buried-layer fill area with thermal vias also helps significantly.

Other than thermal concerns, the PCB layout for the KTS1697A is quite simple. Place the input and output capacitors near the IC. Connect the capacitor ground terminals together and to the GND pins using the top-side copper layer. Route the control signals on buried layers. For internally set 23V OVP, directly connect the OVLO pin to the adjacent GND pins (not shown in Figure 10).

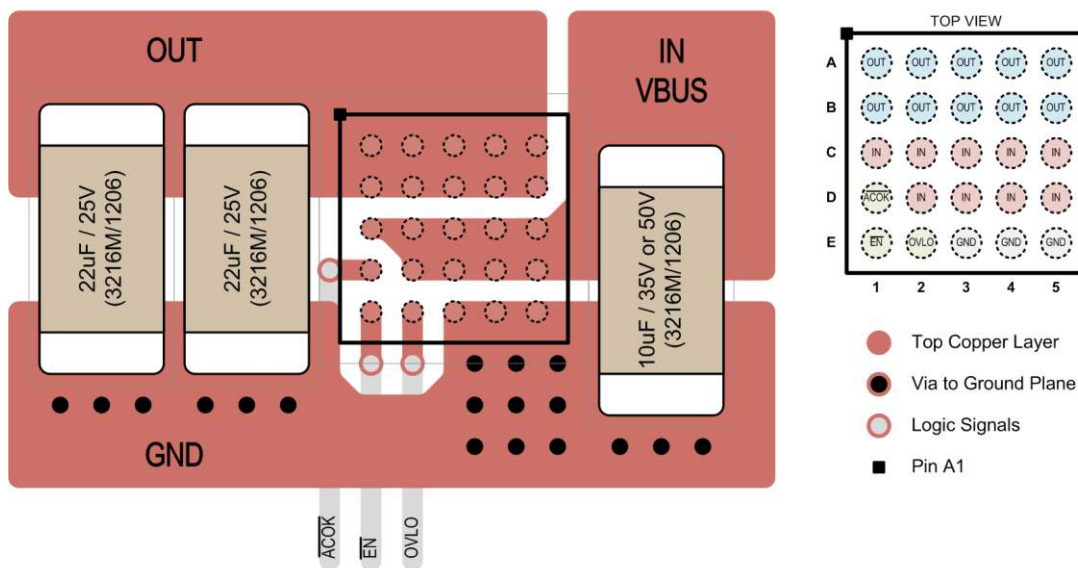
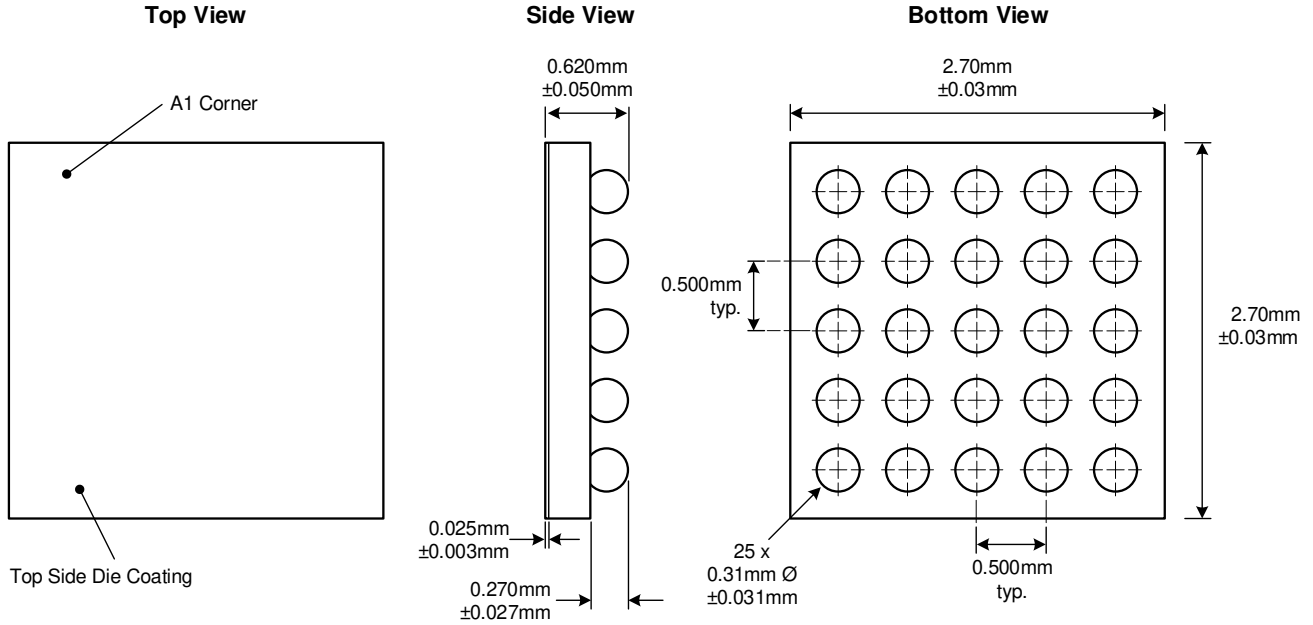

Figure 10. Recommended PCB Layout

Packaging Information

WLCSP55-25 (2.70mm x 2.70mm x 0.62mm)



Recommended Footprint

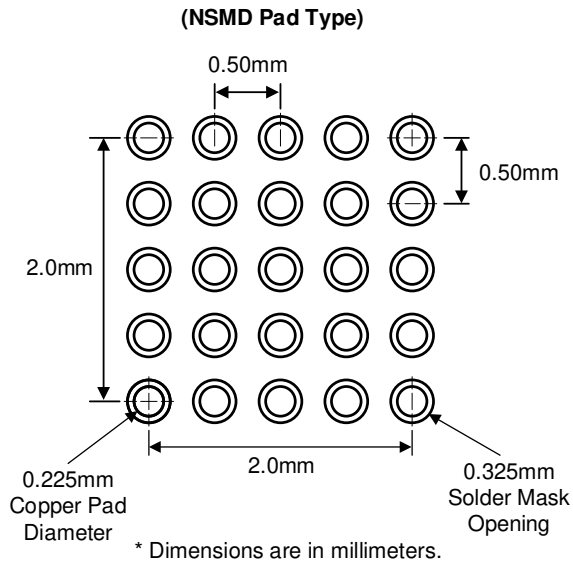

Kinetic Technologies cannot assume responsibility for use of any circuitry other than circuitry entirely embodied in a Kinetic Technologies product. No intellectual property or circuit patent licenses are implied. Kinetic Technologies reserves the right to change the circuitry and specifications without notice at any time.