

FEATURES

- 3-axis sensing**
- Small, low profile package**
3 mm \times 3 mm \times 1.45 mm LFCSP
- Low power: 300 μ A (typical)**
- Single-supply operation: 1.8 V to 3.6 V**
- 10,000 g shock survival**
- Excellent temperature stability**
- Bandwidth adjustment with a single capacitor per axis**
- RoHS/WEEE and lead-free compliant**

APPLICATIONS

- Cost-sensitive, low power, motion- and tilt-sensing applications**
 - Mobile devices
 - Gaming systems
 - Disk drive protection
 - Image stabilization
 - Sports and health devices

GENERAL DESCRIPTION

The ADXL337 is a small, thin, low power, complete 3-axis accelerometer with signal conditioned voltage outputs. The product measures acceleration with a minimum full-scale range of $\pm 3 g$. It can measure the static acceleration of gravity in tilt-sensing applications, as well as dynamic acceleration resulting from motion, shock, or vibration.

The user selects the bandwidth of the accelerometer using the C_X , C_Y , and C_Z capacitors at the X_{OUT} , Y_{OUT} , and Z_{OUT} pins. Bandwidths can be selected to suit the application, with a range of 0.5 Hz to 1600 Hz for X and Y axes and a range of 0.5 Hz to 550 Hz for the Z axis.

The ADXL337 is available in a small, low profile, 3 mm \times 3 mm \times 1.45 mm, 16-lead, lead frame chip scale package (LFCSP_LQ).

FUNCTIONAL BLOCK DIAGRAM

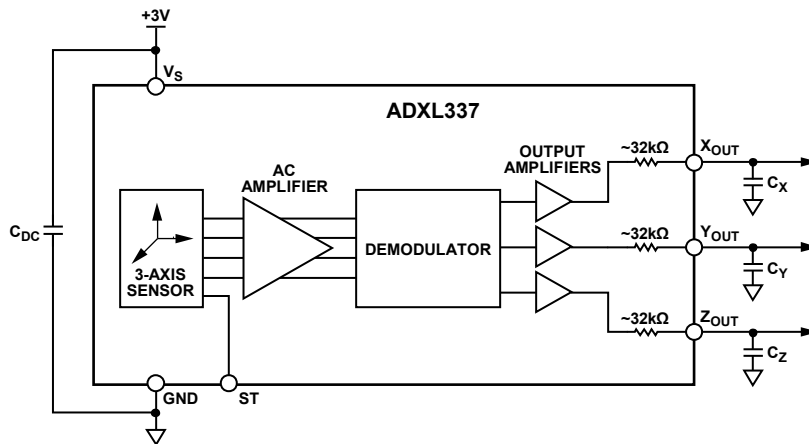

Figure 1.

Rev. 0

Information furnished by Analog Devices is believed to be accurate and reliable. However, no responsibility is assumed by Analog Devices for its use, nor for any infringements of patents or other rights of third parties that may result from its use. Specifications subject to change without notice. No license is granted by implication or otherwise under any patent or patent rights of Analog Devices. Trademarks and registered trademarks are the property of their respective owners.

TABLE OF CONTENTS

Features	1	Applications Information	11
Applications.....	1	Power Supply Decoupling	11
General Description	1	Setting the Bandwidth Using C_x , C_y , and C_z	11
Functional Block Diagram	1	Self Test	11
Revision History	2	Design Trade-Offs for Selecting Filter Characteristics: The Noise/BW Trade-Off.....	11
Specifications.....	3	Use with Operating Voltages Other than 3 V	12
Absolute Maximum Ratings.....	4	Axes of Acceleration Sensitivity	12
ESD Caution.....	4	Layout and Design Recommendations	13
Pin Configuration and Function Descriptions.....	5	Outline Dimensions	14
Typical Performance Characteristics	6	Ordering Guide	14
Theory of Operation	10		
Mechanical Sensor.....	10		
Performance	10		

REVISION HISTORY

10/10—Revision 0: Initial Version

SPECIFICATIONS

$T_A = 25^\circ\text{C}$, $V_S = 3\text{ V}$, $C_X = C_Y = C_Z = 0.1\ \mu\text{F}$, acceleration = 0 g, unless otherwise noted. All minimum and maximum specifications are guaranteed. Typical specifications are not guaranteed.

Table 1.

Parameter	Test Conditions/Comments	Min	Typ	Max	Unit
SENSOR INPUT	Each axis				
Measurement Range		± 3	± 3.6		g
Nonlinearity	% of full scale		± 0.3		%
Package Alignment Error			± 1		Degrees
Interaxis Alignment Error			± 0.1		Degrees
Cross-Axis Sensitivity ¹			± 1		%
SENSITIVITY (RATIOMETRIC) ²	Each axis				
Sensitivity at X_{OUT} , Y_{OUT} , Z_{OUT}	$V_S = 3\text{ V}$	270	300	330	mV/g
Sensitivity Change Due to Temperature ³	$V_S = 3\text{ V}$		± 0.01		%/ $^\circ\text{C}$
0 g BIAS LEVEL (RATIOMETRIC)					
0 g Voltage at X_{OUT} , Y_{OUT}	$V_S = 3\text{ V}$	1.35	1.5	1.65	V
0 g Voltage at Z_{OUT}	$V_S = 3\text{ V}$	1.2	1.5	1.8	V
0 g Offset vs. Temperature X_{OUT} , Y_{OUT}			± 1.1		mg/ $^\circ\text{C}$
0 g Offset vs. Temperature Z_{OUT}			± 1.6		mg/ $^\circ\text{C}$
NOISE PERFORMANCE					
Noise Density X_{OUT} , Y_{OUT}			175		$\mu\text{g}/\sqrt{\text{Hz}}$ rms
Noise Density Z_{OUT}			300		$\mu\text{g}/\sqrt{\text{Hz}}$ rms
FREQUENCY RESPONSE ⁴					
Bandwidth X_{OUT} , Y_{OUT} ⁵	No external filter		1600		Hz
Bandwidth Z_{OUT} ⁵	No external filter		550		Hz
R_{FILT} Tolerance			$32 \pm 15\%$		k Ω
Sensor Resonant Frequency			5.5		kHz
SELF TEST ⁶					
Logic Input Low			0.6		V
Logic Input High			2.4		V
ST Actuation Current			60		μA
Output Change at X_{OUT}	Self test 0 to 1	-150	-325	-600	mV
Output Change at Y_{OUT}	Self test 0 to 1	+150	+325	+600	mV
Output Change at Z_{OUT}	Self test 0 to 1	+150	+550	+1000	mV
OUTPUT AMPLIFIER					
Output Swing Low	No load		0.1		V
Output Swing High	No load		2.8		V
POWER SUPPLY					
Operating Voltage Range ⁷		1.8	3.0	3.6	V
Supply Current	$V_S = 3\text{ V}$		300		μA
Turn-On Time ⁸	No external filter		1		ms
TEMPERATURE					
Operating Temperature Range		-40		+85	$^\circ\text{C}$

¹ Defined as coupling between any two axes.

² Sensitivity is essentially ratiometric to V_S .

³ Defined as the output change from ambient-to-maximum temperature or ambient-to-minimum temperature.

⁴ Actual frequency response controlled by user-supplied external filter capacitors (C_X , C_Y , C_Z).

⁵ Bandwidth with external capacitors = $1/(2 \times \pi \times 32\text{ k}\Omega \times C)$. For C_X , $C_Y = 0.003\ \mu\text{F}$, bandwidth = 1.6 kHz. For $C_Z = 0.01\ \mu\text{F}$, bandwidth = 500 Hz. For C_X , C_Y , $C_Z = 10\ \mu\text{F}$, bandwidth = 0.5 Hz.

⁶ Self test response changes cubically with V_S .

⁷ Tested at 3.0 V and guaranteed by design only (not tested) to work over the full range from 1.8 V to 3.6 V.

⁸ Turn-on time is dependent on C_X , C_Y , C_Z and is approximately $160 \times (C_X \text{ or } C_Y \text{ or } C_Z) + 1$, where C_X , C_Y , and C_Z are in μF and the resulting turn-on time is in ms.

ABSOLUTE MAXIMUM RATINGS

Table 2.

Parameter	Rating
Acceleration (Any Axis, Unpowered)	10,000 <i>g</i>
Acceleration (Any Axis, Powered)	10,000 <i>g</i>
V_s	-0.3 V to +3.6 V
All Other Pins	(GND - 0.3 V) to (V_s + 0.3 V)
Output Short-Circuit Duration (Any Pin to Common)	Indefinite
Temperature Range (Powered)	-55°C to +125°C
Temperature Range (Storage)	-65°C to +150°C

Stresses above those listed under Absolute Maximum Ratings may cause permanent damage to the device. This is a stress rating only; functional operation of the device at these or any other conditions above those indicated in the operational section of this specification is not implied. Exposure to absolute maximum rating conditions for extended periods may affect device reliability.

ESD CAUTION



ESD (electrostatic discharge) sensitive device. Charged devices and circuit boards can discharge without detection. Although this product features patented or proprietary protection circuitry, damage may occur on devices subjected to high energy ESD. Therefore, proper ESD precautions should be taken to avoid performance degradation or loss of functionality.

PIN CONFIGURATION AND FUNCTION DESCRIPTIONS

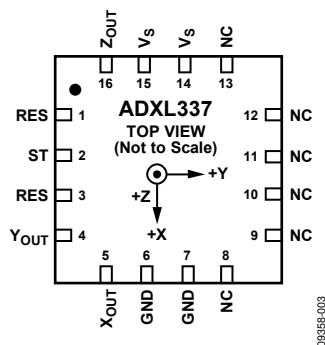

- NOTES
 1. NC = NO CONNECT.
 2. EXPOSED PAD IS NOT INTERNALLY CONNECTED BUT SHOULD BE SOLDERED FOR MECHANICAL INTEGRITY.

Figure 2. Pin Configuration

Table 3. Pin Function Descriptions

Pin No.	Mnemonic	Description
1, 3	RES	Reserved. This pin must be connected to GND or left open.
2	ST	Self Test.
4	Y _{OUT}	Y Channel Output.
5	X _{OUT}	X Channel Output.
6, 7	GND	Must be connected to ground.
8 to 13	NC	Not internally connected.
14	V _s	Supply Voltage (3.0 V typical).
15	V _s	Supply Voltage (3.0 V typical).
16	Z _{OUT}	Z Channel Output.
	EPAD	Exposed Pad. Not internally connected but should be soldered for mechanical integrity.

TYPICAL PERFORMANCE CHARACTERISTICS

N > 250 for all typical performance plots, unless otherwise noted. (N is the number of parts tested and used to produce the histograms.)

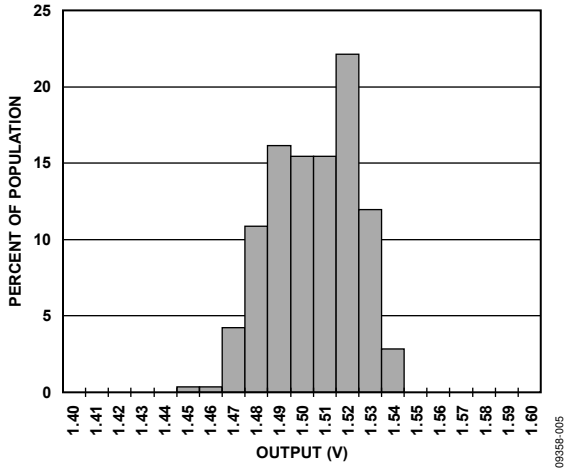

Figure 3. X-Axis Zero g Bias at 25°C, $V_s = 3 V$

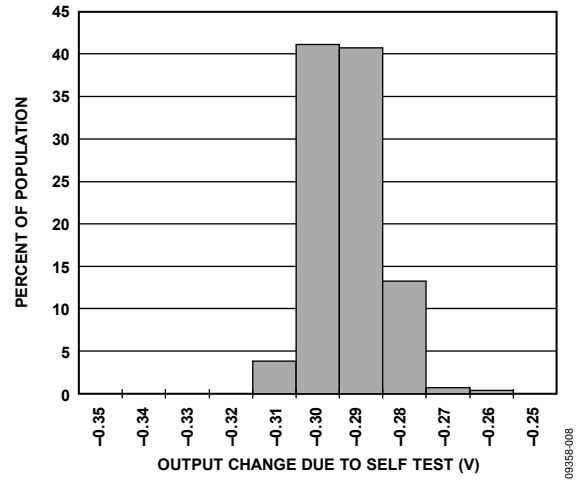

Figure 6. X-Axis Self-Test Response at 25°C, $V_s = 3 V$

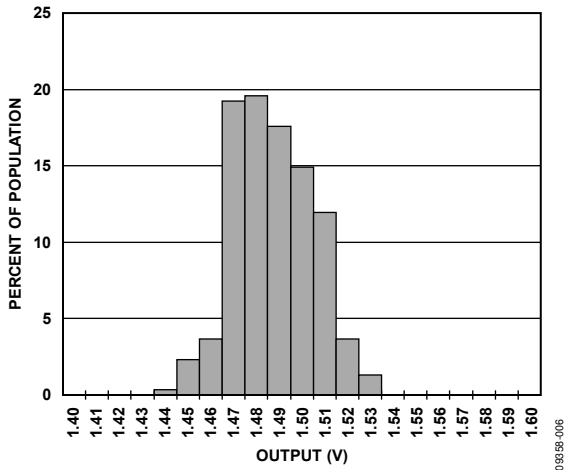

Figure 4. Y-Axis Zero g Bias at 25°C, $V_s = 3 V$

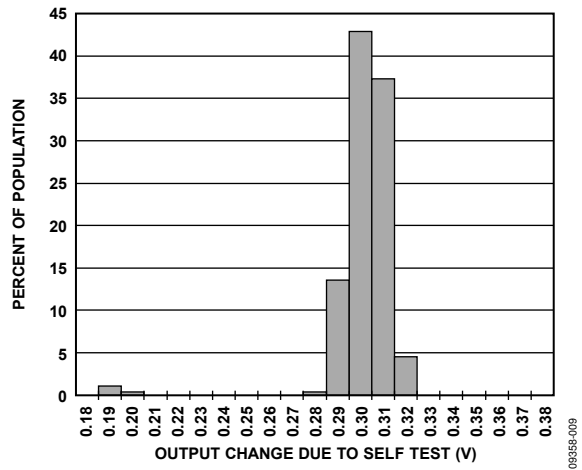

Figure 7. Y-Axis Self-Test Response at 25°C, $V_s = 3 V$

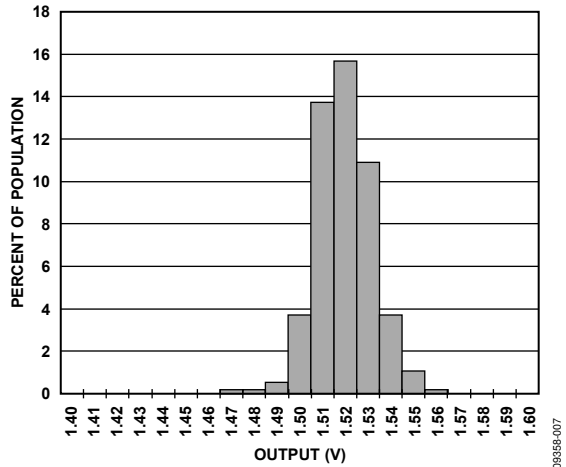

Figure 5. Z-Axis Zero g Bias at 25°C, $V_s = 3 V$

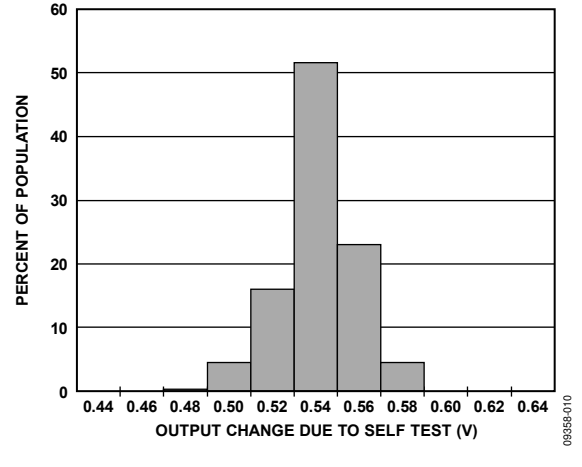

Figure 8. Z-Axis Self-Test Response at 25°C, $V_s = 3 V$

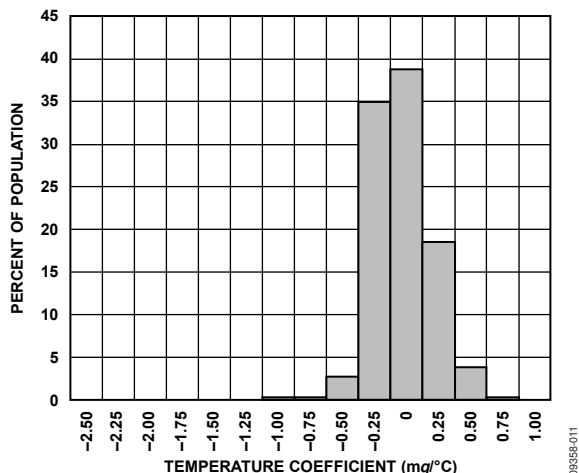

Figure 9. X-Axis Zero g Bias Temperature Coefficient, $V_s = 3\text{ V}$

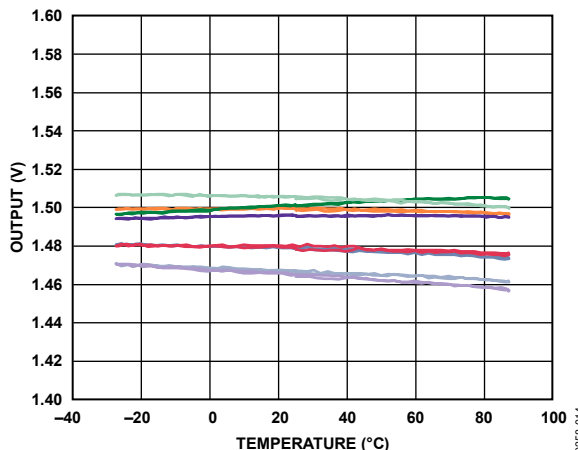

Figure 12. X-Axis Zero g Bias vs. Temperature—Eight Parts Soldered to PCB

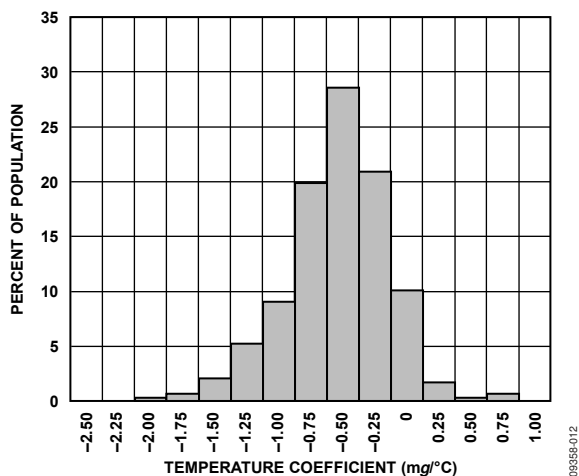

Figure 10. Y-Axis Zero g Bias Temperature Coefficient, $V_s = 3\text{ V}$

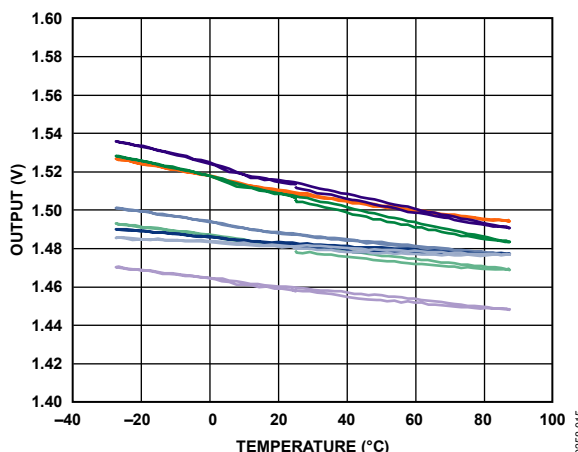

Figure 13. Y-Axis Zero g Bias vs. Temperature—Eight Parts Soldered to PCB

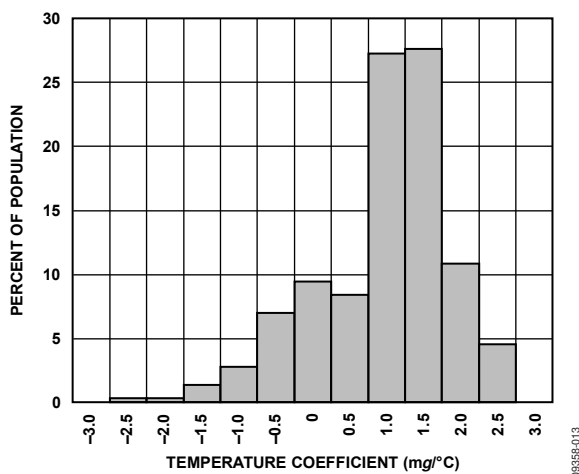

Figure 11. Z-Axis Zero g Bias Temperature Coefficient, $V_s = 3\text{ V}$

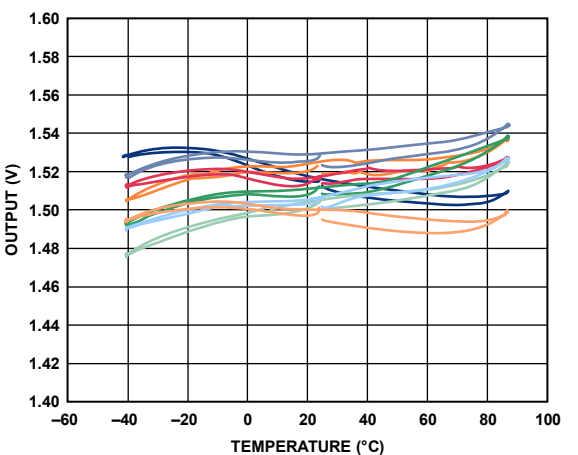

Figure 14. Z-Axis Zero g Bias vs. Temperature—Eight Parts Soldered to PCB

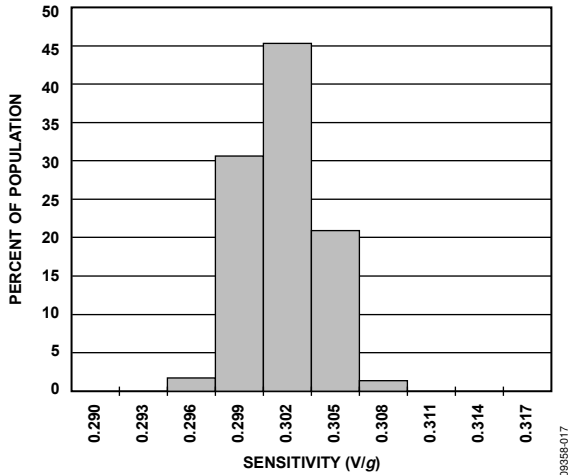

Figure 15. X-Axis Sensitivity at 25°C, V_S = 3 V

09359-017

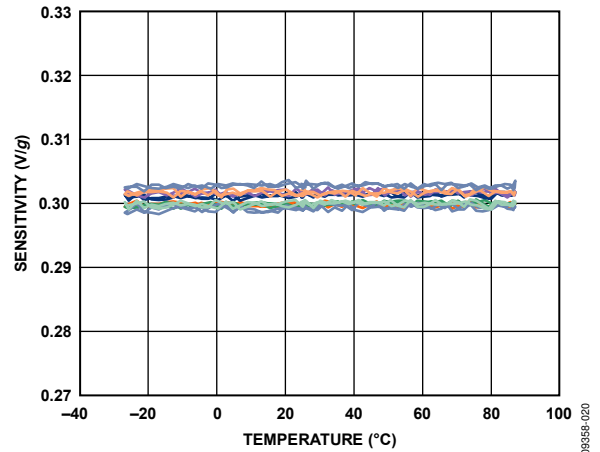

Figure 18. X-Axis Sensitivity vs. Temperature, Eight Parts Soldered to PCB, V_S = 3 V

09359-020

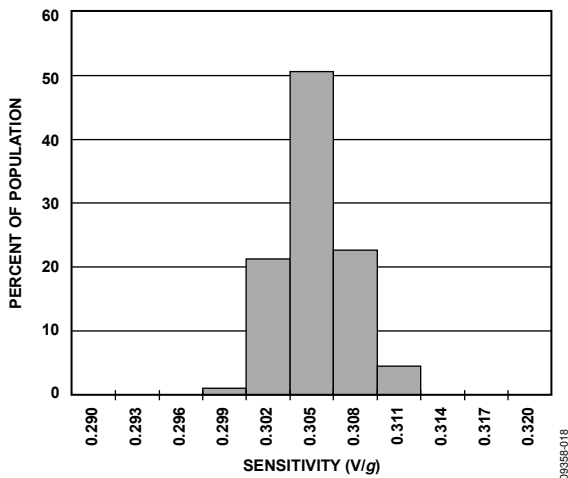

Figure 16. Y-Axis Sensitivity at 25°C, V_S = 3 V

09359-018

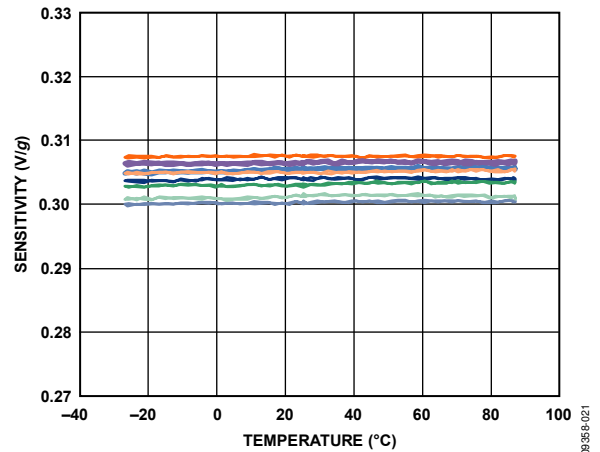

Figure 19. Y-Axis Sensitivity vs. Temperature, Eight Parts Soldered to PCB, V_S = 3 V

09359-021

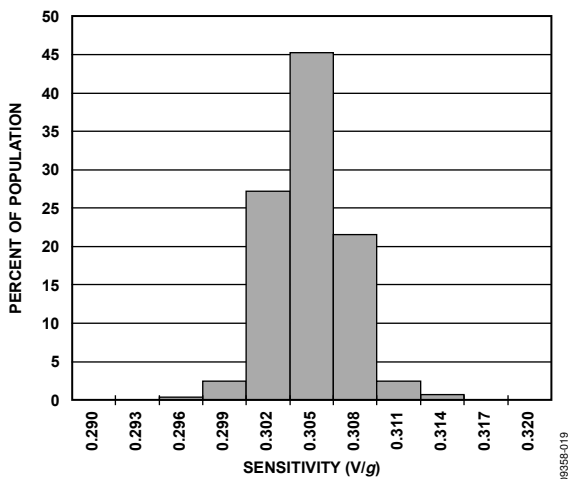

Figure 17. Z-Axis Sensitivity at 25°C, V_S = 3 V

09359-019

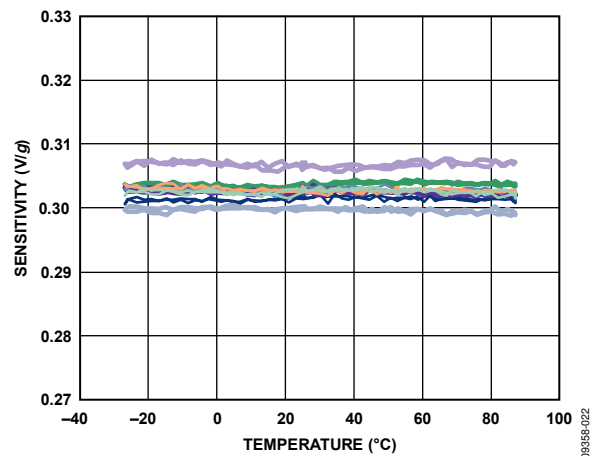

Figure 20. Z-Axis Sensitivity vs. Temperature, Eight Parts Soldered to PCB, V_S = 3 V

09359-022

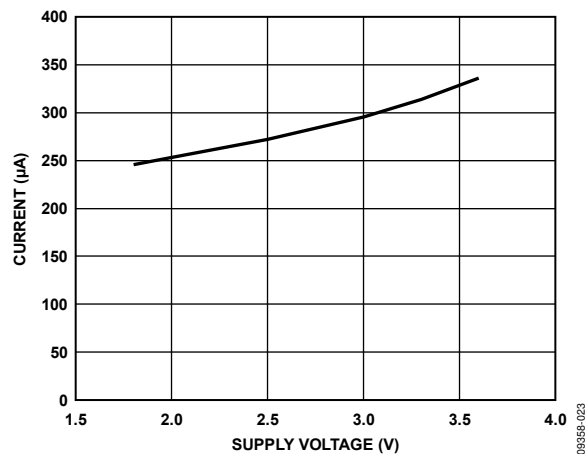

Figure 21. Typical Current Consumption vs. Supply Voltage

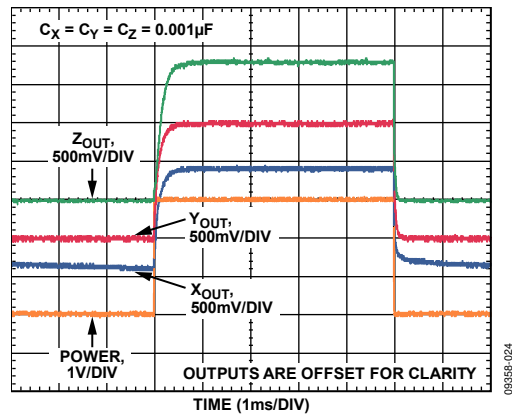

Figure 22. Typical Turn-On Time, $V_s = 3\text{ V}$

THEORY OF OPERATION

The ADXL337 is a complete 3-axis acceleration measurement system. The ADXL337 has a measurement range of ± 3 g minimum. It contains a polysilicon surface micromachined sensor and signal conditioning circuitry to implement an open-loop acceleration measurement architecture. The output signals are analog voltages that are proportional to acceleration. The accelerometer can measure the static acceleration of gravity in tilt-sensing applications as well as dynamic acceleration resulting from motion, shock, or vibration.

The sensor is a polysilicon surface micromachined structure built on top of a silicon wafer. Polysilicon springs suspend the structure over the surface of the wafer and provide a resistance against acceleration forces. Deflection of the structure is measured using a differential capacitor that consists of independent fixed plates and plates attached to the moving mass. The fixed plates are driven by 180° out-of-phase square waves. Acceleration deflects the moving mass and unbalances the differential capacitor resulting in a sensor output whose amplitude is proportional to acceleration. Phase-sensitive demodulation techniques are then used to determine the magnitude and direction of the acceleration.

The demodulator output is amplified and brought off chip through a 32 k Ω resistor. The user then sets the signal bandwidth (BW) of the device by adding a capacitor. This filtering improves measurement resolution and helps prevent aliasing.

MECHANICAL SENSOR

The ADXL337 uses a single structure for sensing the X, Y, and Z axes. As a result, the three axes sense directions are highly orthogonal with little cross-axis sensitivity. Mechanical misalignment of the sensor die to the package is the chief source of cross-axis sensitivity. Mechanical misalignment can be calibrated out at the system level.

PERFORMANCE

Rather than using additional temperature compensation circuitry, innovative design techniques ensure that high performance is built into the ADXL337. As a result, there is neither quantization error nor nonmonotonic behavior, and temperature hysteresis is very low (typically less than 3 mg over the -25°C to $+85^{\circ}\text{C}$ temperature range).

APPLICATIONS INFORMATION

POWER SUPPLY DECOUPLING

For most applications, a single 0.1 μF capacitor, C_{DC} , placed close to the ADXL337 supply pins adequately decouples the accelerometer from noise on the power supply. However, in applications where noise is present at the 50 kHz internal clock frequency (or any harmonic thereof), additional care in power supply bypassing is required because this noise can cause errors in acceleration measurement. If additional decoupling is needed, a 100 Ω (or smaller) resistor or ferrite bead can be inserted in the supply line. Additionally, a larger bulk bypass capacitor (1 μF or greater) can be added in parallel to C_{DC} . Ensure that the connection from the ADXL337 ground to the power supply ground is low impedance because noise transmitted through ground has a similar effect as noise transmitted through V_{S} .

SETTING THE BANDWIDTH USING C_{X} , C_{Y} , AND C_{Z}

The ADXL337 has provisions for band limiting the X_{OUT} , Y_{OUT} , and Z_{OUT} pins. Capacitors must be added at these pins to implement low-pass filtering for antialiasing and noise reduction. The equation for the 3 dB bandwidth is

$$f_{-3 \text{ dB}} = 1/(2\pi(32 \text{ k}\Omega) \times C_{(X, Y, Z)})$$

or more simply

$$f_{-3 \text{ dB}} = 5 \mu\text{F}/C_{(X, Y, Z)}$$

The tolerance of the internal resistor (R_{FILT}) typically varies as much as $\pm 15\%$ of its nominal value (32 k Ω), and the bandwidth varies accordingly. A minimum capacitance of 0.0047 μF for C_{X} , C_{Y} , and C_{Z} is recommended in all cases.

Table 4. Filter Capacitor Selection, C_{X} , C_{Y} , and C_{Z}

Bandwidth (Hz)	Capacitor (μF)
1	4.7
10	0.47
50	0.10
100	0.05
200	0.027
500	0.01

SELF TEST

The ST pin controls the self test feature. When this pin is set to V_{S} , an electrostatic force is exerted on the accelerometer beam. The resulting movement of the beam allows the user to test if the accelerometer is functional. The typical change in output is -1.08 g (corresponding to -325 mV) in the X-axis, $+1.08 \text{ g}$ (or $+325 \text{ mV}$) on the Y-axis, and $+1.83 \text{ mg}$ (or $+550 \text{ mV}$) on the Z-axis. This ST pin can be left open circuit or connected to common (GND) in normal use.

Never expose the ST pin to voltages greater than $V_{\text{S}} + 0.3 \text{ V}$. If this cannot be guaranteed due to the system design (for instance, if there are multiple supply voltages), then a low V_{F} clamping diode between ST and V_{S} is recommended.

DESIGN TRADE-OFFS FOR SELECTING FILTER CHARACTERISTICS: THE NOISE/BW TRADE-OFF

The selected accelerometer bandwidth ultimately determines the measurement resolution (smallest detectable acceleration). Filtering can be used to lower the noise floor to improve the resolution of the accelerometer. Resolution is dependent on the analog filter bandwidth at X_{OUT} , Y_{OUT} , and Z_{OUT} .

The output of the ADXL337 has a typical bandwidth of greater than 500 Hz. The user must filter the signal at this point to limit aliasing errors. The analog bandwidth must be no more than half the analog-to-digital sampling frequency to minimize aliasing. The analog bandwidth can be decreased further to reduce noise and improve resolution.

The ADXL337 noise has the characteristics of white Gaussian noise, which contributes equally at all frequencies and is described in terms of $\mu\text{g}/\sqrt{\text{Hz}}$ (the noise is proportional to the square root of the accelerometer bandwidth). The user should limit bandwidth to the lowest frequency needed by the application to maximize the resolution and dynamic range of the accelerometer.

With the single-pole, roll-off characteristic, the typical noise of the ADXL337 is determined by

$$\text{rms Noise} = \text{Noise Density} \times (\sqrt{\text{BW}} \cdot 1.6)$$

It is often useful to know the peak value of the noise. Peak-to-peak noise can only be estimated by statistical methods. Table 5 is useful for estimating the probabilities of exceeding various peak values, given the rms value.

Table 5. Estimation of Peak-to-Peak Noise

Peak-to-Peak Value	Percent of Time that Noise Exceeds Nominal Peak-to-Peak Value
$2 \times \text{rms}$	32
$4 \times \text{rms}$	4.6
$6 \times \text{rms}$	0.27
$8 \times \text{rms}$	0.006

ADXL337

USE WITH OPERATING VOLTAGES OTHER THAN 3 V

The ADXL337 is tested and specified at $V_S = 3\text{ V}$; however, it can be powered with V_S as low as 1.8 V or as high as 3.6 V. Note that some performance parameters change as the supply voltage is varied.

The ADXL337 output is ratiometric; therefore, the output sensitivity (or scale factor) varies proportionally to the supply voltage. At $V_S = 3.6\text{ V}$, the output sensitivity is typically 360 mV/g. At $V_S = 2\text{ V}$, the output sensitivity is typically 195 mV/g.

The zero g bias output is also ratiometric; therefore, the zero g output is nominally equal to $V_S/2$ at all supply voltages.

The output noise is not ratiometric but is absolute in volts; therefore, the noise density decreases as the supply voltage increases. This is because the scale factor (mV/g) increases while the noise voltage remains constant. At $V_S = 3.6\text{ V}$, the X- and Y-axis noise density is typically $120\text{ }\mu\text{g}/\sqrt{\text{Hz}}$, and at $V_S = 2\text{ V}$, the X- and Y-axis noise density is typically $270\text{ }\mu\text{g}/\sqrt{\text{Hz}}$.

Self test response in g is roughly proportional to the square of the supply voltage. However, when ratiometricity of sensitivity is factored in with supply voltage, the self test response in volts is roughly proportional to the cube of the supply voltage. For example, at $V_S = 3.6\text{ V}$, the self test response for the ADXL337 is approximately -560 mV for the X-axis, +560 mV for the Y-axis, and +950 mV for the Z-axis.

At $V_S = 2\text{ V}$, the self test response is approximately -96 mV for the X-axis, +96 mV for the Y-axis, and -163 mV for the Z-axis.

The supply current decreases as the supply voltage decreases. Typical current consumption at $V_S = 3.6\text{ V}$ is 375 μA , and typical current consumption at $V_S = 2\text{ V}$ is 200 μA .

AXES OF ACCELERATION SENSITIVITY

The axes of sensitivity for the accelerometer are shown in Figure 23, and Figure 24 shows the output response when the accelerometer is oriented parallel to each of these axes.

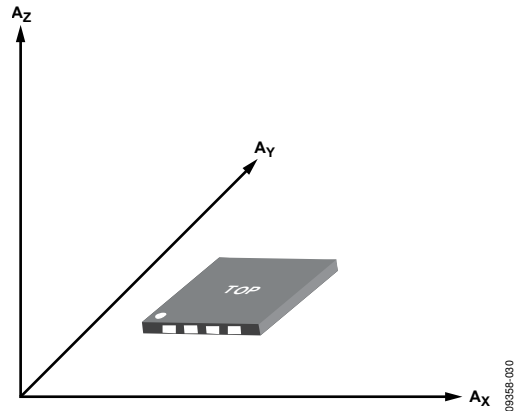

Figure 23. Axes of Acceleration Sensitivity, Corresponding Output Voltage Increases When Accelerated Along the Sensitive Axis

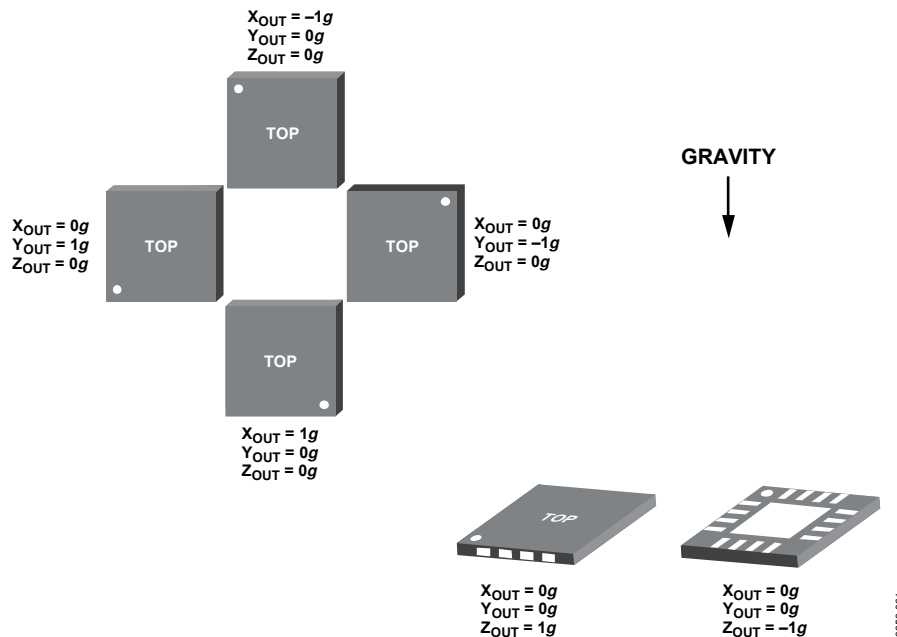

Figure 24. Output Response vs. Orientation to Gravity

LAYOUT AND DESIGN RECOMMENDATIONS

The recommended soldering profile is shown in Figure 25 followed by a description of the profile features in Table 6. The recommended PCB layout or solder land drawing is shown in Figure 26.

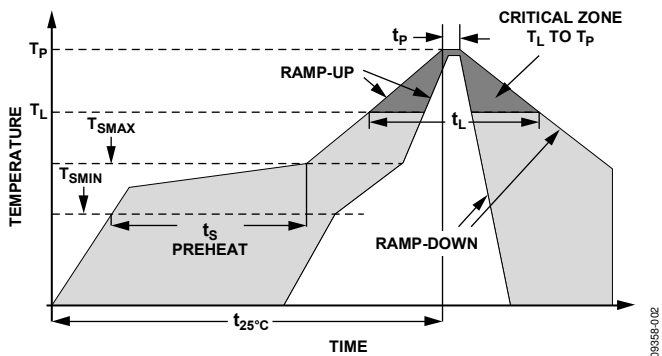

Figure 25. Recommended Soldering Profile

Table 6. Recommended Soldering Profile

Profile Feature	Sn63/Pb37	Pb-Free
Average Ramp Rate (T_L to T_P)	3°C/sec maximum	3°C/sec maximum
Preheat		
Minimum Temperature (T_{SMIN})	100°C	150°C
Maximum Temperature (T_{SMAX})	150°C	200°C
Time (T_{SMIN} to T_{SMAX}), t_s	60 sec to 120 sec	60 sec to 180 sec
T_{SMAX} to T_L		
Ramp-Up Rate	3°C/sec maximum	3°C/sec maximum
Time Maintained Above Liquidous (T_L)		
Liquidous Temperature (T_L)	183°C	217°C
Time (t_L)	60 sec to 150 sec	60 sec to 150 sec
Peak Temperature (T_P)	240°C + 0°C/-5°C	260°C + 0°C/-5°C
Time within 5°C of Actual Peak Temperature (t_p)	10 sec to 30 sec	20 sec to 40 sec
Ramp-Down Rate	6°C/sec maximum	6°C/sec maximum
Time 25°C to Peak Temperature ($t_{25°C}$)	6 minutes maximum	8 minutes maximum

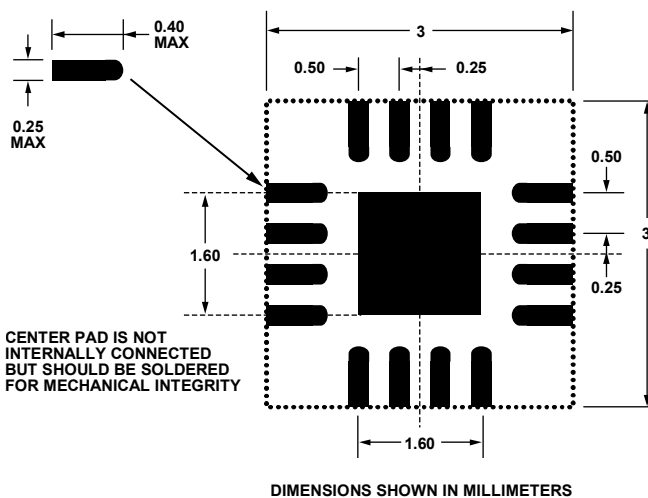

Figure 26. Recommended PCB Layout

OUTLINE DIMENSIONS

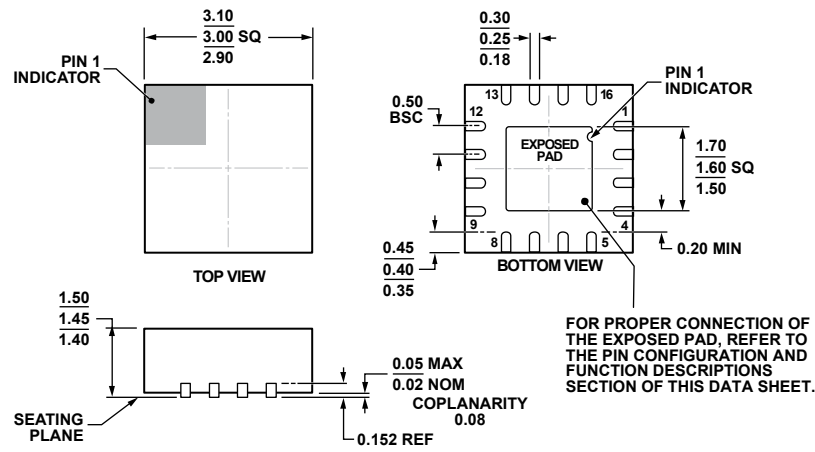

Figure 27. 16-Lead Lead Frame Chip Scale Package [LFCSP_LQ]
 3 mm × 3 mm Body, Thick Quad
 (CP-16-28)
 Dimensions shown in millimeters

ORDERING GUIDE

Model ¹	Measurement Range	Specified Voltage	Temperature Range	Package Description	Package Option
ADXL337BCPZ-RL	±3 g	3 V	-40°C to +85°C	16-Lead LFCSP_LQ	CP-16-28
ADXL337BCPZ-RL7	±3 g	3 V	-40°C to +85°C	16-Lead LFCSP_LQ	CP-16-28
EVAL-ADXL337Z				Evaluation Board	

¹ Z = RoHS Compliant Part.

NOTES

ADXL337

NOTES