

3-TO-1 DVI/HDMI SWITCH

FEATURES

- Compatible with HDMI 1.3a
- Supports 2.25 Gbps Signaling Rate for 480i/p, 720i/p, and 1080i/p Resolutions up to 12-Bit Color Depth
- Each Port Supports HDMI or DVI Inputs
- Isolated Digital Display Control (DDC) Bus for Unused Ports
- 5-V Tolerance to all DDC and HPD_SINK Inputs
- Integrated Receiver Termination
- Inter-Pair Output Skew < 100 ps
- Intra-Pair Skew < 50 ps
- 8-dB Receiver Equalization to Compensate for 5-m DVI Cable Losses
- High Impedance Outputs When Disabled
- TMDS Inputs HBM ESD Protection

Exceeds 5 kV

- 3.3-V Supply Operation
- 80-Pin TQFP Package
- ROHS Compatible and 260°C Reflow Rated

APPLICATIONS

- Switching From Three Digital-Video (DVI) or Digital-Audio Visual (HDMI) Sources
- Digital TV
- Digital Projector
- Audio Video Receiver

DESCRIPTION

The TMDS341A is a 3-port digital video interface (DVI) or high-definition multimedia interface (HDMI) switch that allows up to 3 DVI or HDMI ports to be switched to a single display terminal. Four TMDS channels, one hot plug detector, and an I²C interface are supported on each port. Each TMDS channel allows signaling rates up to 2.25 Gbps.

The active source is selected by configuring source selectors, S1, S2, and S3. The selected TMDS inputs from each port are switched through a 3-to-1 multiplexer. The I²C interface of the selected input port is linked to the I²C interface of the output port, and the hot plug detector (HPD) of the selected input port is output to HPD_SINK. For the unused ports, the I²C interfaces are isolated, and the HPD pins are kept low.

Termination resistors (50-Ω), pulled up to V_{CC}, are integrated at each receiver input pin. External terminations are not required. A precision resistor is connected externally from the VSADJ pin to ground for setting the differential output voltage to be compliant with the TMDS standard. When the output is connected to a standard TMDS termination and \overline{OE} is high, the output is high impedance.

The TMDS341A provides fixed 8-dB input equalization and selectable 3-dB output de-emphasis to optimize system performance through 5-meter or longer DVI compliant cables. The device is characterized for operation from 0°C to 70°C.

Typical Application

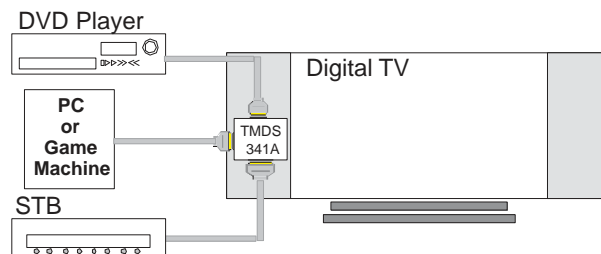

Please be aware that an important notice concerning availability, standard warranty, and use in critical applications of Texas Instruments semiconductor products and disclaimers thereto appears at the end of this data sheet.



These devices have limited built-in ESD protection. The leads should be shorted together or the device placed in conductive foam during storage or handling to prevent electrostatic damage to the MOS gates.

FUNCTIONAL BLOCK DIAGRAM

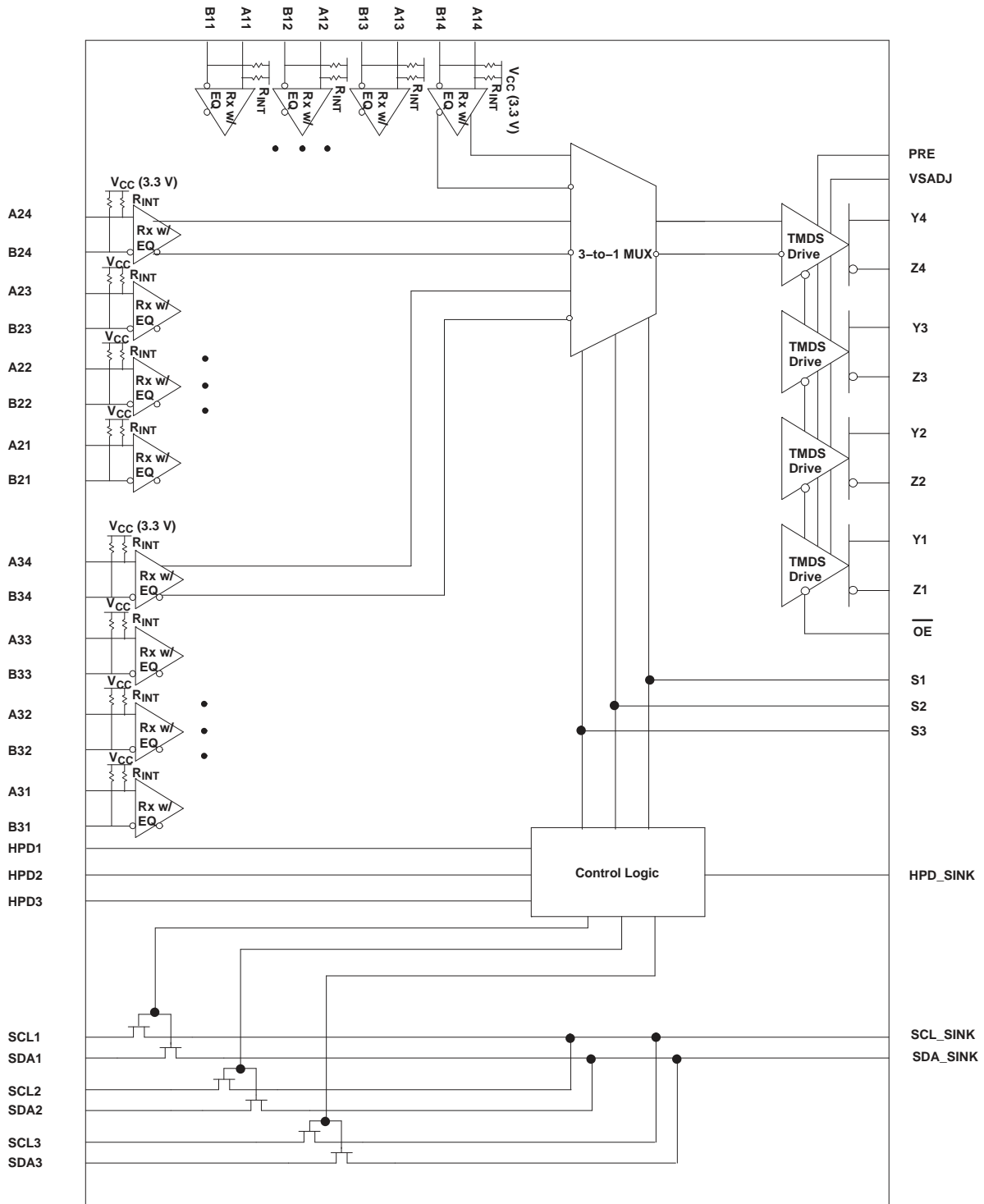

**PFC PACKAGE
(TOP VIEW)**

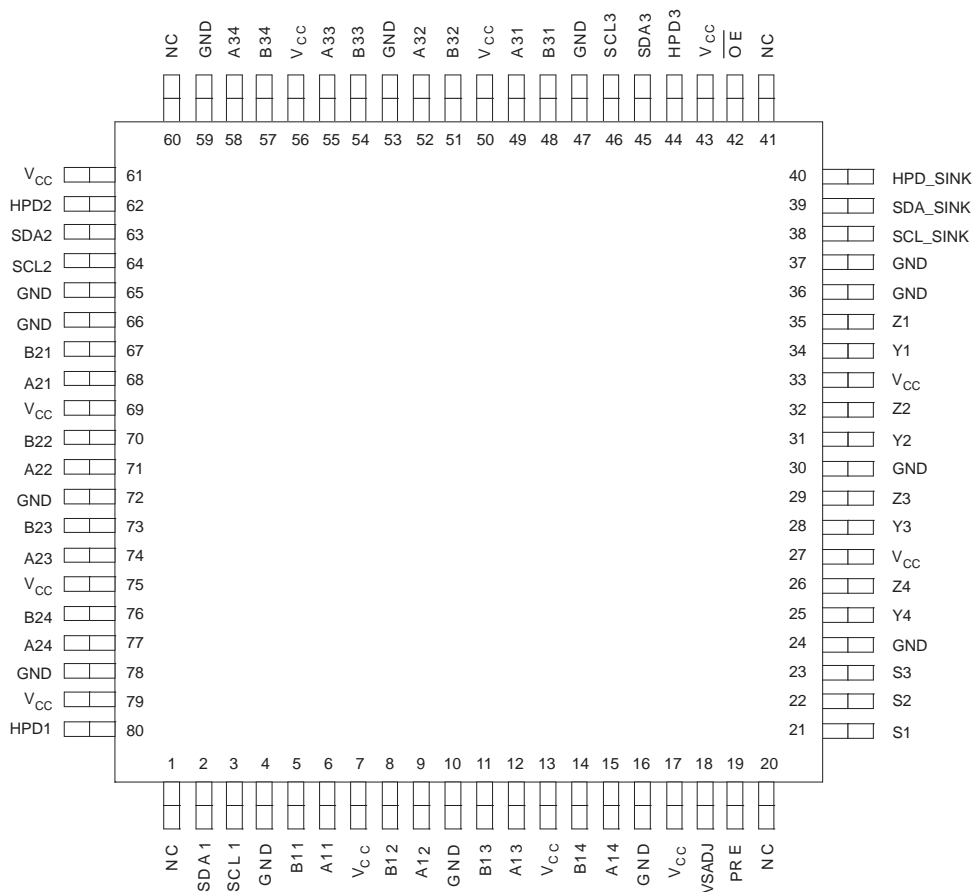

TERMINAL FUNCTIONS

TERMINAL		I/O	DESCRIPTION
NAME	NO.		
A11, A12, A13, A14	6, 9, 12, 15	I	Port 1 TMDS positive inputs
A21, A22, A23, A24	68, 71, 74, 77	I	Port 2 TMDS positive inputs
A31, A32, A33, A34	49, 52, 55, 58	I	Port 3 TMDS positive inputs
B11, B12, B13, B14	5, 8, 11, 14	I	Port 1 TMDS negative inputs
B21, B22, B23, B24	67, 70, 73, 76	I	Port 2 TMDS negative inputs
B31, B32, B33, B34	48, 51, 54, 57	I	Port 3 TMDS negative inputs
GND	4, 10, 16 24, 30, 36, 37, 47, 53, 59, 65, 66, 72, 78		Ground
HPD1	80	O	Port 1 hot plug detector output
HPD2	62	O	Port 2 hot plug detector output
HPD3	44	O	Port 3 hot plug detector output
HPD_SINK	40	I	Sink side hot plug detector input High: 5-V power signal asserted from source to sink and EDID is ready Low: No 5-V power signal asserted from source to sink, or EDID is not ready
NC	1, 20, 41,60		No connect
OE	42	I	Output enable, active low
PRE	19	I	Output de-emphasis adjustment High: 3 dB Low: 0 dB
SCL1	3	I/O	Port 1 DDC bus clock line
SCL2	64	I/O	Port 2 DDC bus clock line
SCL3	46	I/O	Port 3 DDC bus clock line
SCL_SINK	38	I/O	Sink side DDC bus clock line
SDA1	2	I/O	Port 1 DDC bus data line
SDA2	63	I/O	Port 2 DDC bus data line
SDA3	45	I/O	Port 3 DDC bus data line
SDA_SINK	39	I/O	Sink side DDC bus data line
S1, S2, S3	21, 22, 23	I	Source selector input
V _{CC}	7, 13, 17 27, 33, 43, 50, 56 61, 69, 75, 79		Power supply
VSADJ	18	I	TMDS compliant voltage swing control
Y1, Y2, Y3, Y4	34, 31, 28, 25	O	TMDS positive outputs
Z1, Z2, Z3, Z4	35, 32, 29, 26	O	TMDS negative outputs

Table 1. Source Selection Lookup⁽¹⁾

CONTROL PINS			I/O SELECTED		HOT PLUG DETECT STATUS		
S1	S2	S3	Y/Z	SCL_SINK SDA_SINK	HPD1	HPD2	HPD3
H	x	x	A1/B1	SCL1 SDA1	HPD_SINK	L	L
L	H	x	A2/B2	SCL2 SDA2	L	HPD_SINK	L
L	L	H	A3/B3	SCL3 SDA3	L	L	HPD_SINK
L	L	L	None (Z)	None (Z)	L	L	L

(1) H: Logic high; L: Logic low; X: Don't care; Z: High impedance

EQUIVALENT INPUT AND OUTPUT SCHEMATIC DIAGRAMS

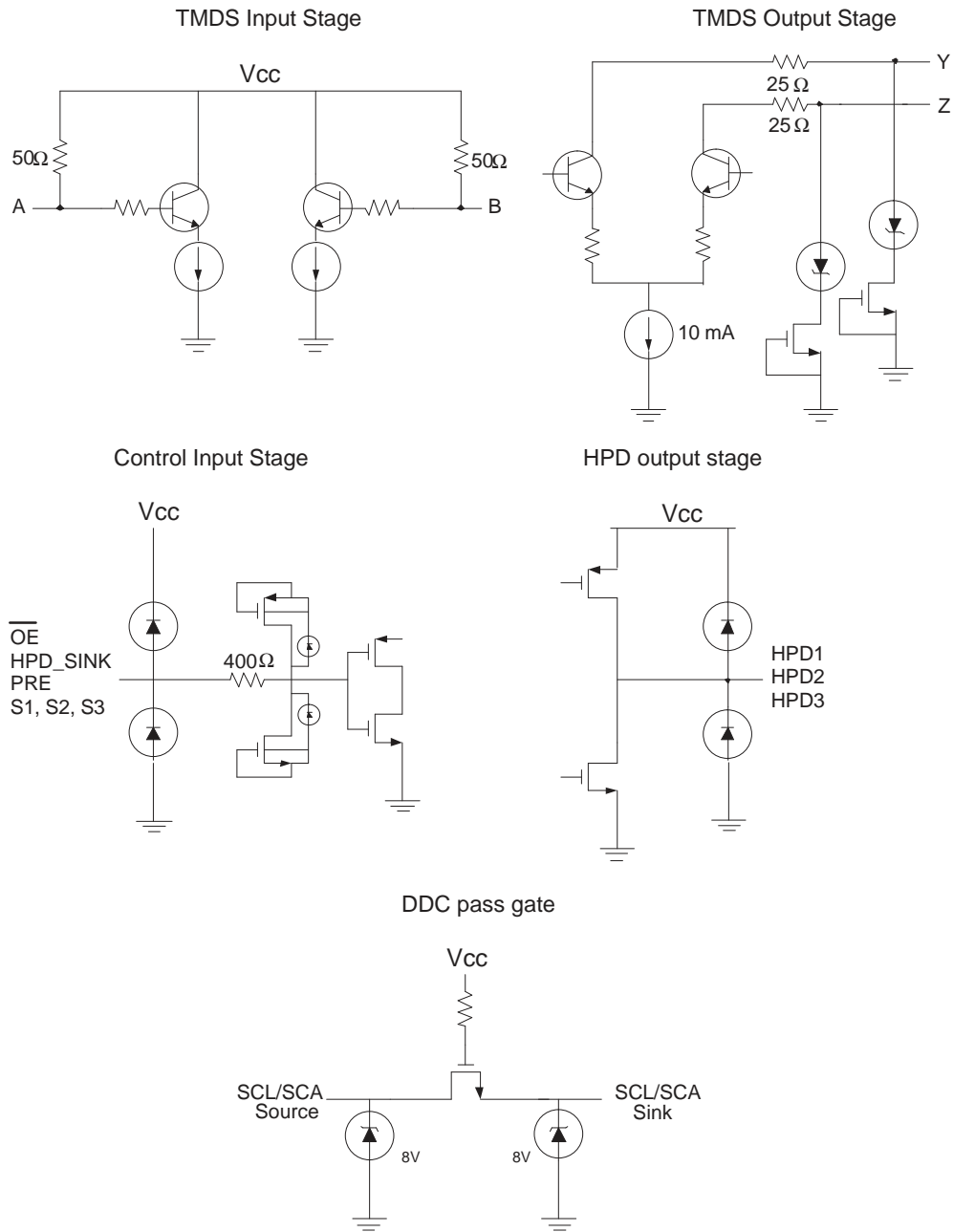

ORDERING INFORMATION⁽¹⁾

PART NUMBER	PART MARKING	PACKAGE
TMDS341APFC	TMDS341A	80-PIN TQFP
TMDS341APFCR	TMDS341A	80-PIN TQFP Tape/Reel

(1) For the most current package and ordering information, see the Package Option Addendum at the end of this document, or see the TI web site at www.ti.com.

ABSOLUTE MAXIMUM RATINGS

over operating free-air temperature range (unless otherwise noted)⁽¹⁾

		UNIT	
Supply voltage range, V_{CC} ⁽²⁾		–0.5 V to 4 V	
Voltage range	Anm ⁽³⁾ , Bnm	2.5 V to 4 V	
	Ym, Zm, VSADJ, PRE, Sn, \overline{OE} , HPDn	–0.5V to 4 V	
	SCLn, SCL_SINK, SDA _n , SDA_SINK, HPD_SINK	–0.5 V to 6 V	
Electrostatic discharge	Human body model ⁽⁴⁾	Anm, Bnm	5 kV
		All pins	4 kV
	Charged-device model ⁽⁵⁾ (all pins)	1000 V	
	Machine model ⁽⁶⁾ (all pins)	250 V	
Continuous power dissipation		See Dissipation Rating Table	

- (1) Stresses beyond those listed under *absolute maximum ratings* may cause permanent damage to the device. These are stress ratings only and functional operation of the device at these or any other conditions beyond those indicated under *recommended operating conditions* is not implied. Exposure to absolute-maximum-rated conditions for extended periods may affect device reliability.
- (2) All voltage values, except differential I/O bus voltages, are with respect to network ground terminal.
- (3) n = 1, 2, 3; m = 1, 2, 3, 4
- (4) Tested in accordance with JEDEC Standard 22, Test Method A114-B
- (5) Tested in accordance with JEDEC Standard 22, Test Method C101-A
- (6) Tested in accordance with JEDEC Standard 22, Test Method A115-A

DISSIPATION RATINGS

PACKAGE	$T_A \leq 25^\circ\text{C}$	DERATING FACTOR ⁽¹⁾ ABOVE $T_A = 25^\circ\text{C}$	$T_A = 70^\circ\text{C}$ POWER RATING
80-TQFP	1342 mW	13.42 mW/°C	738 mW

- (1) This is the inverse of the junction-to-ambient thermal resistance when board-mounted and with no air flow.

RECOMMENDED OPERATING CONDITIONS

		MIN	NOM	MAX	UNIT
V_{CC}	Supply voltage	3	3.3	3.6	V
T_A	Operating free-air temperature	0		70	°C
TMDS DIFFERENTIAL PINS (A/B)					
V_{ID}	Receiver peak-to-peak differential input voltage	150		1560	mVp-p
V_{IC}	Input common mode voltage	$V_{CC}-0.4$		$V_{CC}+0.01$	V
R_{VSADJ}	Resistor for TMDS compliant voltage swing range	4.6	4.64	4.68	k Ω
AV_{CC}	TMDS output termination voltage, see Figure 1	3	3.3	3.6	V
R_T	Termination resistance, see Figure 1	45	50	55	Ω
	Signaling rate	0		2.25	Gbps
CONTROL PINS (PRE; S, \overline{OE})					
V_{IH}	LVTTL High-level input voltage	2		V_{CC}	V
V_{IL}	LVTTL Low-level input voltage	GND		0.8	V
DDC I/O PINS (SCL, SCL_SINK, SDA, SDA_SINK)					
$V_{I(DDC)}$	Input voltage	GND		5.5	V
STATUS PINS (HPD_SINK)					
V_{IH}	LVTTL High-level input voltage	2		5.3	V
V_{IL}	LVTTL Low-level input voltage	GND		0.8	V

ELECTRICAL CHARACTERISTICS

over recommended operating conditions (unless otherwise noted)

PARAMETER	TEST CONDITIONS	MIN	TYP ⁽¹⁾	MAX	UNIT
I _{CC} Supply current	V _{IH} = V _{CC} , V _{IL} = V _{CC} - 0.4 V, R _{VSADJ} = 4.64 kΩ, R _T = 50 Ω, AV _{CC} = 3.3 V, Am/Bm = 1.65 Gbps HDMI data pattern, m = 2, 3, 4, A1/B1 = 165 MHz clock		190	230	mA
P _D Power dissipation	V _{IH} = V _{CC} , V _{IL} = V _{CC} - 0.4 V, R _{VSADJ} = 4.64 kΩ, R _T = 50 Ω, AV _{CC} = 3.3 V, Am/Bm = 1.65 Gbps HDMI data pattern, m = 2, 3, 4, A1/B1 = 165 MHz clock		394	657	mW
TMDS DIFFERENTIAL PINS (A/B; Y/Z)					
V _{OH} Single-ended high-level output voltage	See Figure 2, AV _{CC} = 3.3 V, R _T = 50 Ω, PRE = 0 V	AV _{CC} -10		AV _{CC} +10	mV
V _{OL} Single-ended low-level output voltage		AV _{CC} -600		AV _{CC} -400	mV
V _{swing} Single-ended output swing voltage		400		600	mV
V _{OD(O)} Overshoot of output differential voltage			6%	15%	2× V _{swing}
V _{OD(U)} Undershoot of output differential voltage			12%	25%	2× V _{swing}
ΔV _{OC(SS)} Change in steady-state common-mode output voltage between logic states				0.5	5
I _{(O)OFF} Single-ended standby output current	0 V ≤ V _{CC} ≤ 1.5 V, AV _{CC} = 3.3 V, R _T = 50 Ω	-10		10	μA
I _(OS) Short circuit output current	See Figure 3			12	mA
V _{ODE(SS)} Steady state output differential voltage with de-emphasis	See Figure 4, PRE = V _{CC} , Am/Bm = 250 Mbps HDMI data pattern, m = 2, 3, 4, A1/B1 = 25 MHz clock		560	840	mVp-p
V _{ODE(pp)} Peak-to-peak output differential voltage			800	1200	mVp-p
V _{I(open)} Single-ended input voltage under high impedance input or open input	I _I = 10 μA	V _{CC} -10		V _{CC} +10	mV
R _{INT} Input termination resistance	V _{IN} = 2.9 V	45	50	55	Ω
DDC I/O PINS (SCL, SCL_SINK, SDA, SDA_SINK)					
I _{IKG} Input leakage current	V _I = 0.1 V _{CC} to 0.9 V _{CC} to isolated DDC ports		0.1	2	μA
C _{IO} Input/output capacitance	V _I = 0 V		7.5		pF
R _{ON} Switch resistance	I _O = 3 mA, V _O = 0.4 V		25	50	Ω
V _{PASS} Switch output voltage	V _I = 3.3 V, I _O = 100 μA	1.5 ⁽²⁾	2.0	2.5 ⁽³⁾	V
STATUS PINS (HPD)					
V _{OH(TTL)} TTL High-level output voltage	I _{OH} = -8 mA		2.4		V
V _{OL(TTL)} TTL Low-level output voltage	I _{OL} = 8 mA			0.4	V
CONTROL PINS (PRE, S, OE)					
I _{IH} High-level digital input current	V _{IH} = 2 V or V _{CC}		0.1	2	μA
I _{IL} Low-level digital input current	V _{IL} = GND or 0.8 V		0.1	2	μA
STATUS PINS (HPD_SINK)					
I _{IH} High-level digital input current	V _{IH} = 5.3 V		23	100	μA
	V _{IH} = 2 V or V _{CC}		0.1	2	
I _{IL} Low-level digital input current	V _{IL} = GND or 0.8 V		0.1	2	μA

- (1) All typical values are at 25°C and with a 3.3-V supply.
- (2) The value is tested in full temperature range at 3.0 V.
- (3) The value is tested in full temperature range at 3.6 V.

SWITCHING CHARACTERISTICS

over recommended operating conditions (unless otherwise noted)

PARAMETER		TEST CONDITIONS	MIN	TYP ⁽¹⁾	MAX	UNIT
TMDS DIFFERENTIAL PINS (Y/Z)						
t_{PLH}	Propagation delay time, low-to-high-level output	See Figure 2, $AV_{CC} = 3.3\text{ V}$, $R_T = 50\ \Omega$, $PRE = 0\text{ V}$	250		800	ps
t_{PHL}	Propagation delay time, high-to-low-level output		250		800	ps
t_r	Differential output signal rise time (20% - 80%)		75		240	ps
t_f	Differential output signal fall time (20% - 80%)		75		240	ps
$t_{sk(p)}$	Pulse skew ($t_{PHL} - t_{PLH}$)			7	50	ps
$t_{sk(D)}$	Intra-pair differential skew, see Figure 5			23	50	ps
$t_{sk(o)}$	Inter-pair channel-to-channel output skew ⁽²⁾				100	ps
$t_{sk(pp)}$	Part-to-part skew ⁽³⁾				200	ps
$t_{jit(pp)}$	Peak-to-peak output jitter from Y/Z(1) residual jitter	See Figure 8, $PRE = 0\text{ V}$ $Am/Bm = 1.65\text{ Gbps HDMI data pattern}$, $m = 2, 3, 4$ $A1/B1 = 165\text{ MHz clock}$		15	30	ps
$t_{jit(pp)}$	Peak-to-peak output jitter from Y/Z(2:4) residual jitter			18	50	ps
$t_{jit(pp)}$	Peak-to-peak output jitter from Y/Z(1) residual jitter	See Figure 8, $PRE = 0\text{ V}$ $Am/Bm = 2.25\text{ Gbps HDMI data pattern}$, $m = 2, 3, 4$ $A1/B1 = 225\text{ MHz clock}$		20	22	ps
$t_{jit(pp)}$	Peak-to-peak output jitter from Y/Z(2:4) residual jitter			38	78	ps
t_{PRE}	De-emphasis duration	See Figure 4, $PRE = V_{CC}$ $Am/Bm = 250\text{ Mbps HDMI data pattern}$, $m = 2, 3, 4$ $A1/B1 = 25\text{ MHz clock}$		240 ⁽⁴⁾		ps
t_{SX}	Select to switch output	See Figure 6		6	10	ns
t_{en}	Enable time			6	10	ns
t_{dis}	Disable time			6	10	ns
DDC I/O PINS (SCL, SCL_SINK, SDA, SDA_SINK)						
$t_{pd(DDC)}$	Propagation delay from SCLn to SCL_SINK or SDAn to SDA_SINK or SDA_SINK to SDAn	See Figure 7, $C_L = 10\text{ pF}$		0.4	2.5	ns
CONTROL AND STATUS PINS (S, HPD_SINK, HPD)						
$t_{pd(HPD)}$	Propagation delay (from HPD_SINK to the active port of HPD)	See Figure 7, $C_L = 10\text{ pF}$		2	6.0	ns
$t_{sx(HPD)}$	Switch time (from port select to the latest valid status of HPD)			3	6.5	ns

(1) All typical values are at 25°C and with a 3.3-V supply.

(2) $t_{sk(o)}$ is the magnitude of the difference in propagation delay times between any specified terminals of channel 2 to 4 of a device when inputs are tied together.

(3) $t_{sk(pp)}$ is the magnitude of the difference in propagation delay times between any specified terminals of channel 2 to 4 of two devices, or between channel 1 of two devices, when both devices operate with the same source, the same supply voltages, at the same temperature, and have identical packages and test circuits.

(4) The typical value is ensured by simulation.

PARAMETER MEASUREMENT INFORMATION

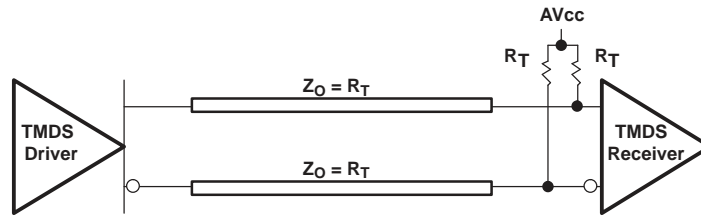
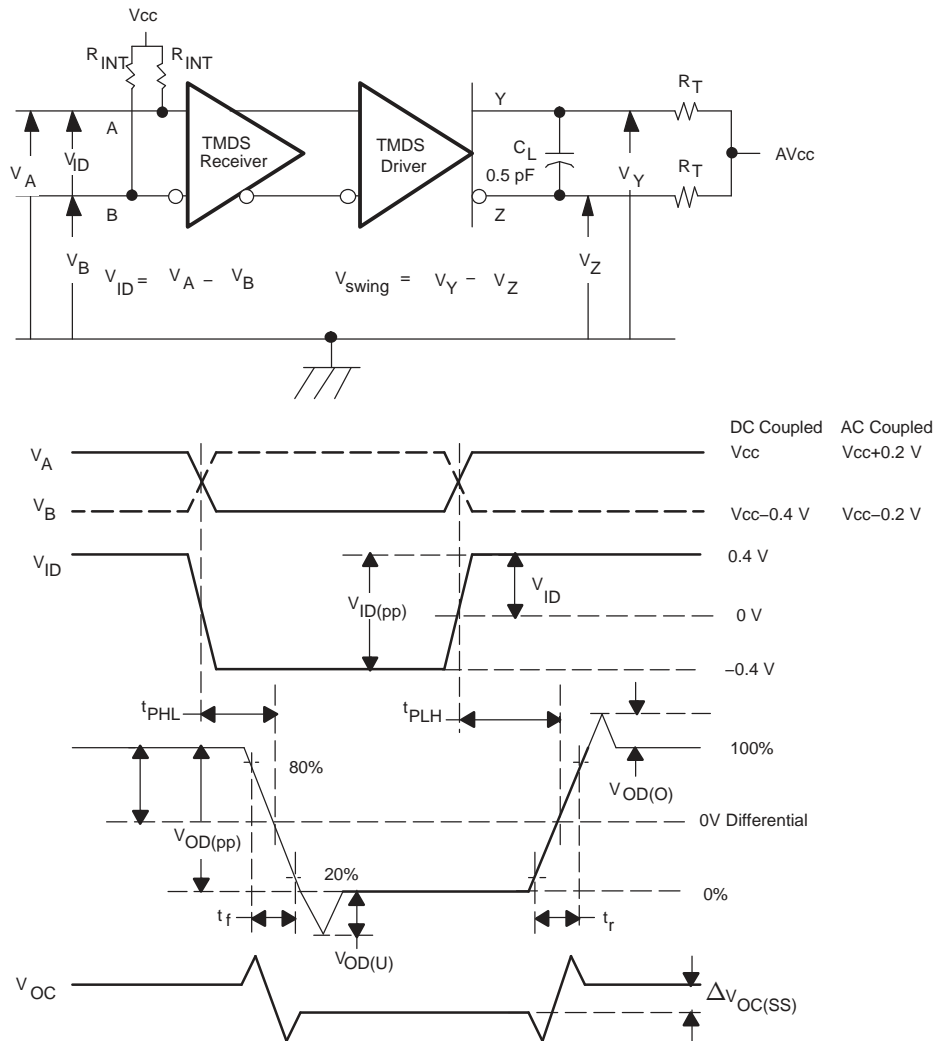

Figure 1. Termination for TMD5 Output Driver



NOTE: All input pulses are supplied by a generator having the following characteristics: t_r or $t_f < 100\text{ ps}$, 100 MHz from Agilent 81250. C_L includes instrumentation and fixture capacitance within 0.06 m of the D.U.T. Measurement equipment provides a bandwidth of 20 GHz minimum.

Figure 2. Timing Test Circuit and Definitions

PARAMETER MEASUREMENT INFORMATION (continued)

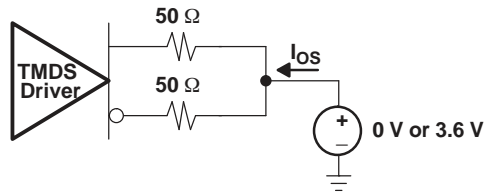

Figure 3. Short Circuit Output Current Test Circuit

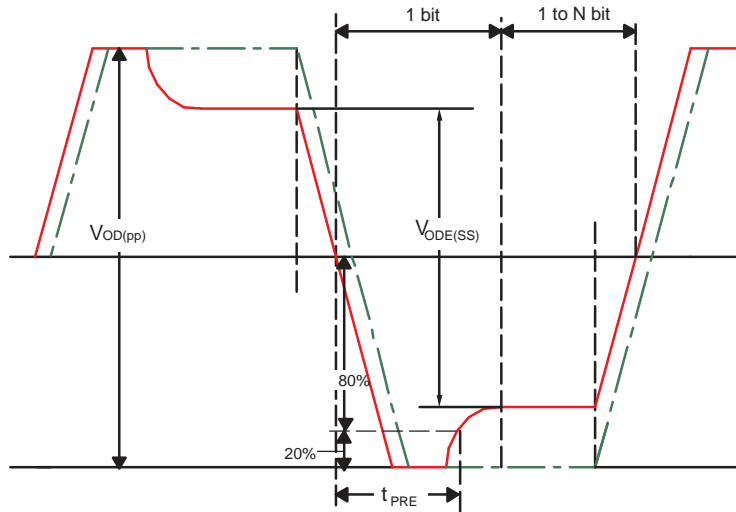

Figure 4. De-Emphasis Output Voltage Waveforms and Duration Measurement Definitions

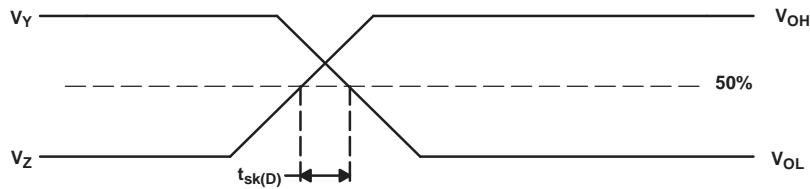

Figure 5. Definition of Intra-Pair Differential Skew

PARAMETER MEASUREMENT INFORMATION (continued)

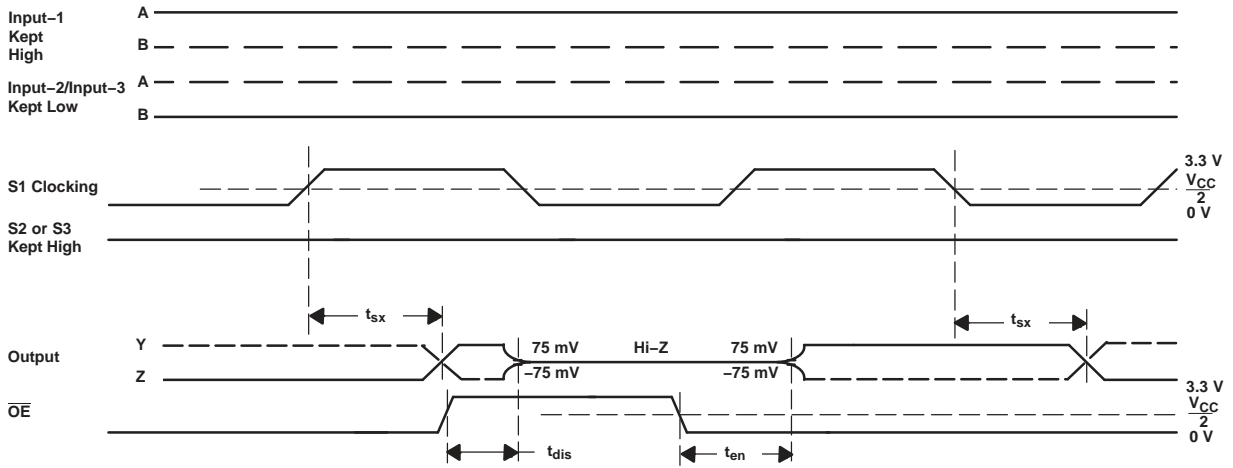

Figure 6. TMDS Outputs Control Timing Definitions

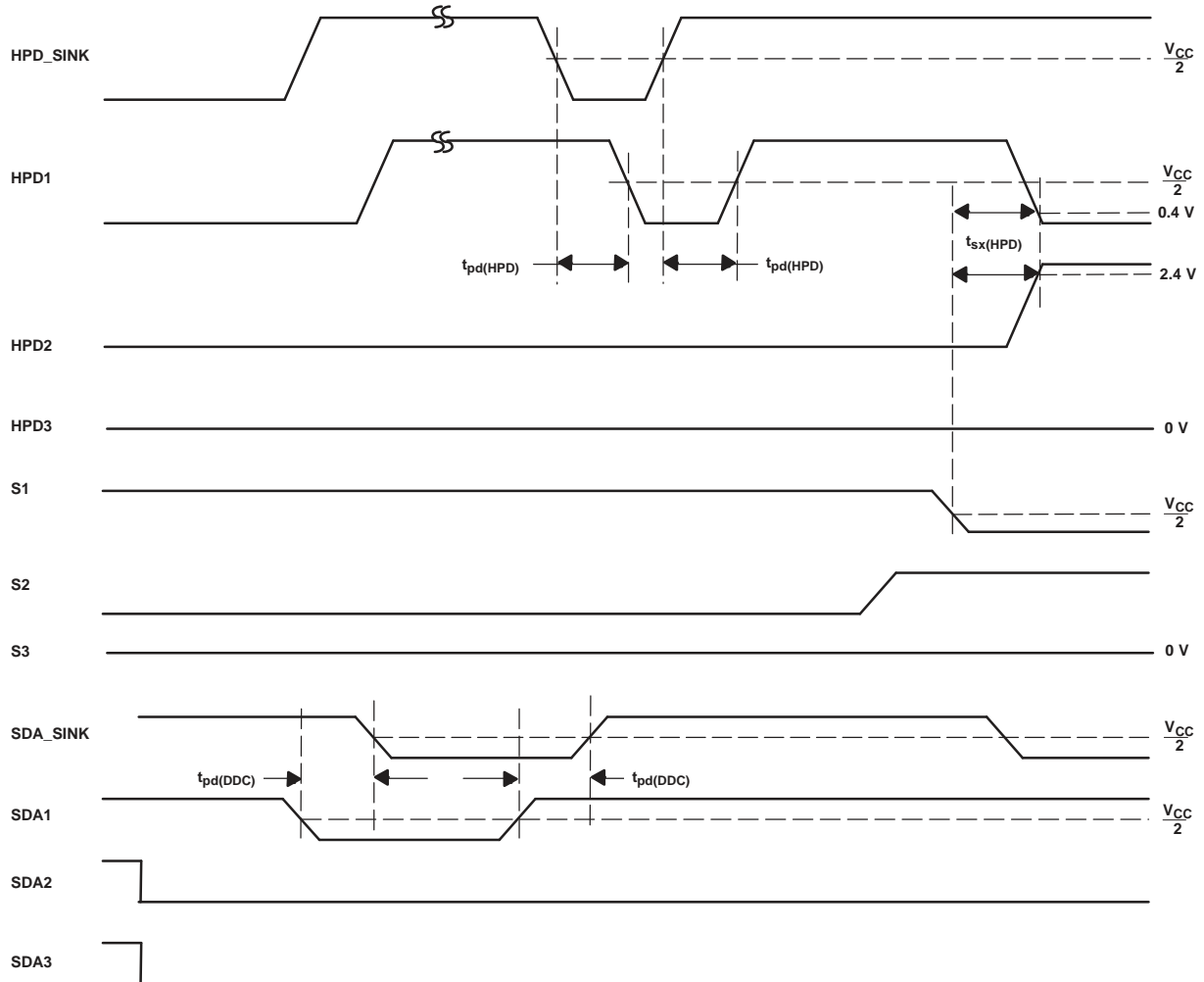
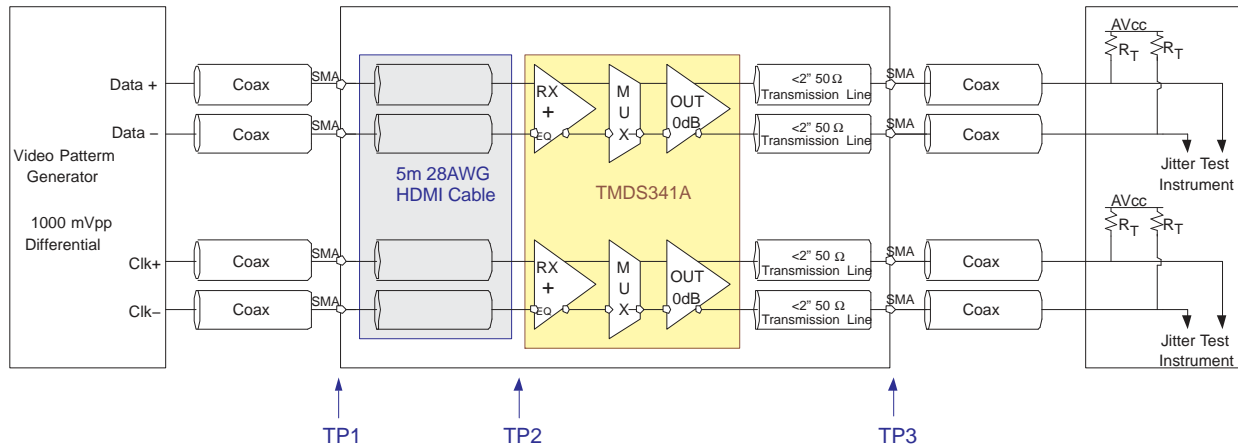

Figure 7. HPD Timing Definitions

PARAMETER MEASUREMENT INFORMATION (continued)



- A. All jitters are measured in BER of 10^{-12}
- B. The residual jitter reflects the total jitter measured at the TMDS341A output, TP3, subtract the total jitter from the signal generator, TP1

Figure 8. Jitter Test Circuit

Figure 9 shows the frequency loss response from a 5m 28AWG HDMI cable and a 5m 28AWG DVI cable. The TMDS341A built-in passive input equalizer compensates for ISI. For an 8-dB loss HDMI cable, the TMDS341A typically reduces jitter by 60 ps from the device input to the device output.

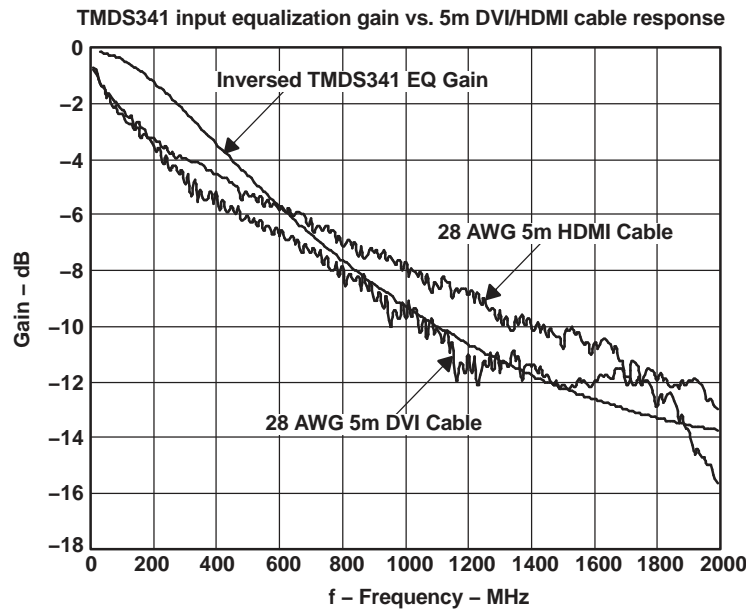

Figure 9. S-Parameter Plots of 5-m DVI and HDMI Cables

TYPICAL CHARACTERISTICS

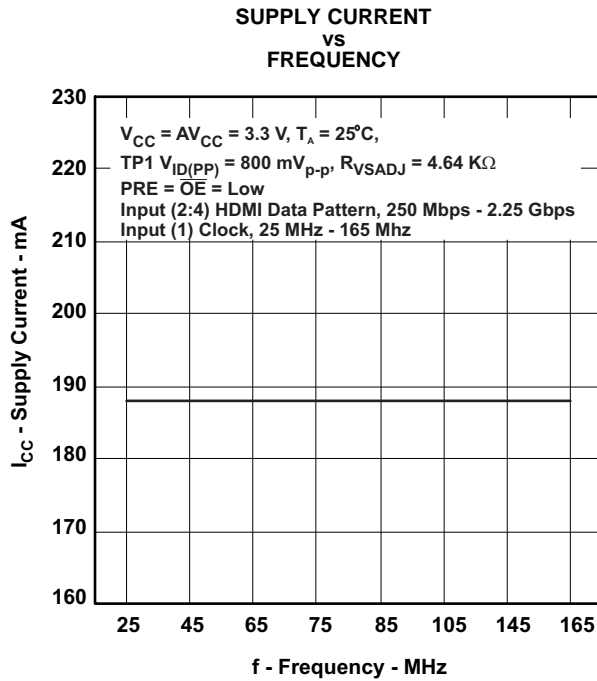

Figure 10.

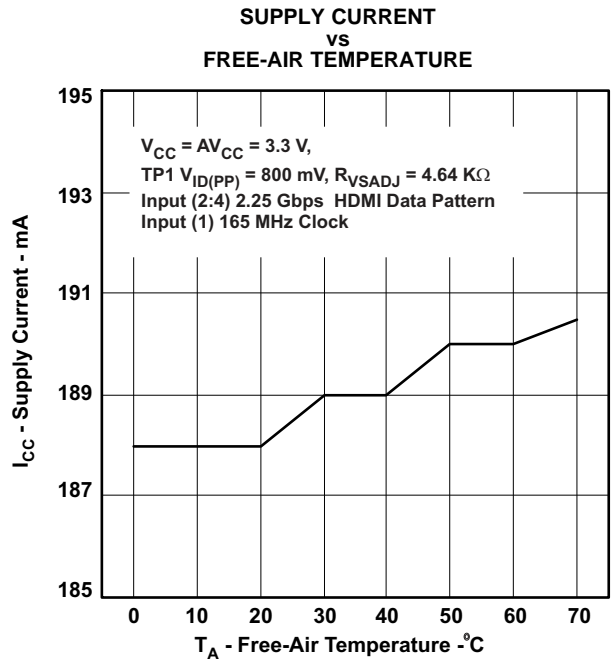

Figure 11.

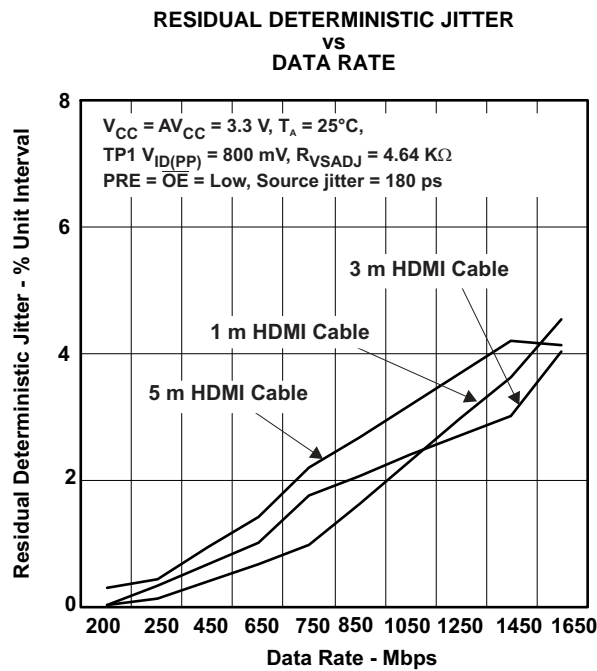

Figure 12.

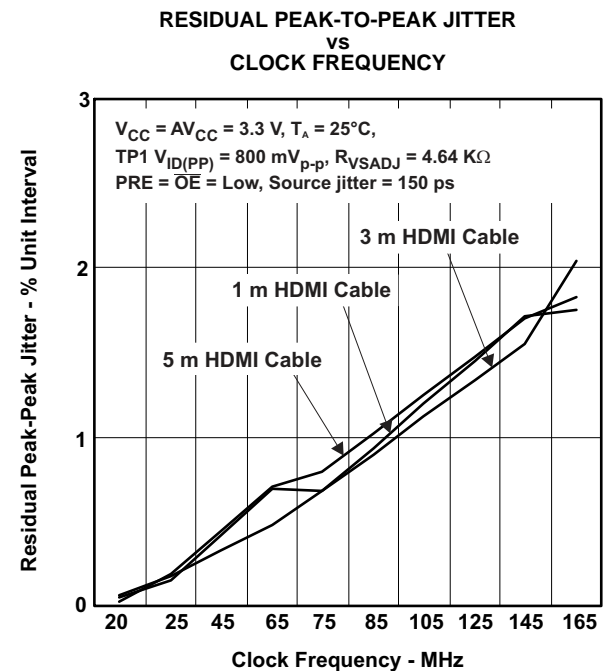

Figure 13.

TYPICAL CHARACTERISTICS (continued)

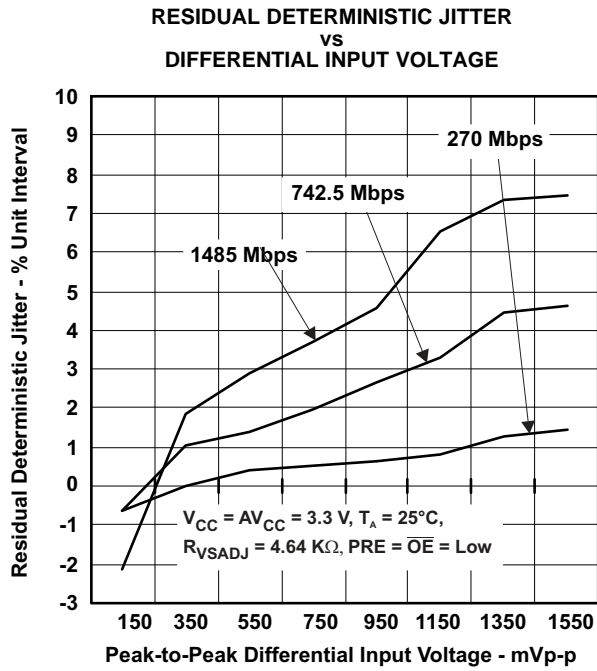

Figure 14.

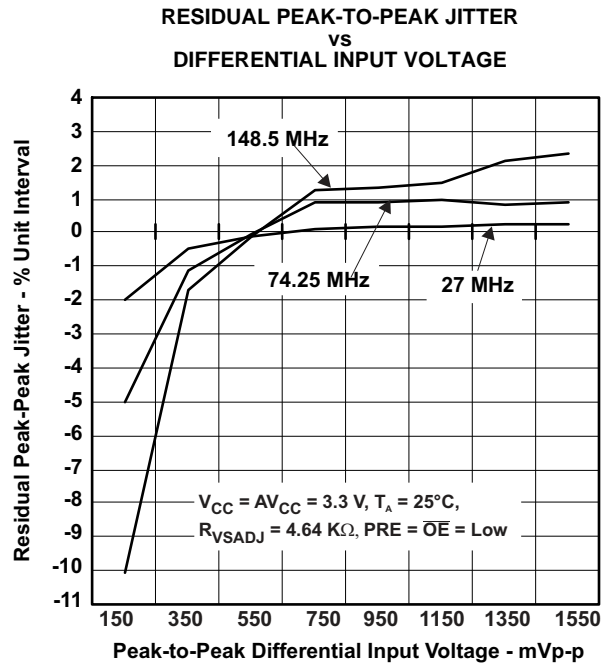

Figure 15.

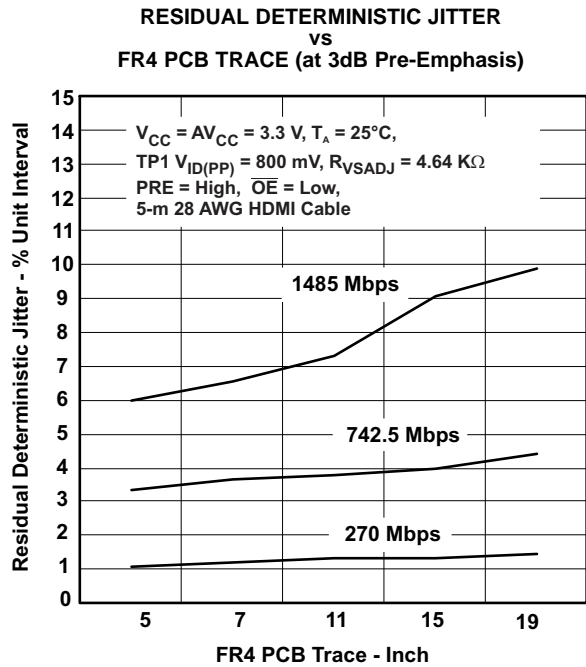

Figure 16.

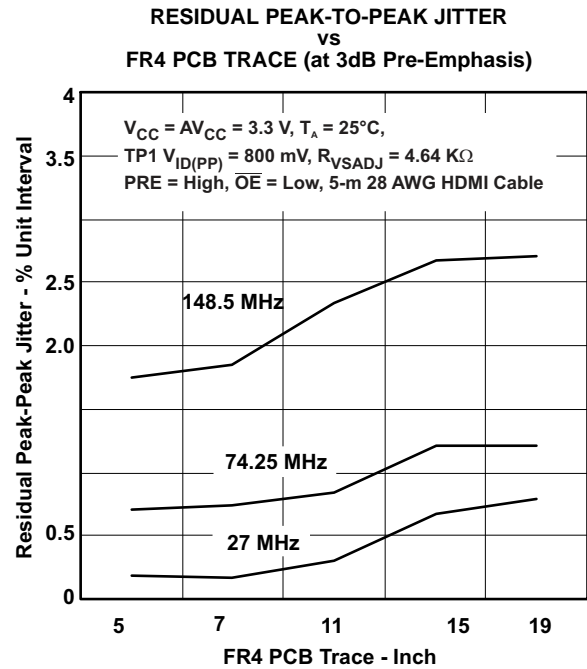
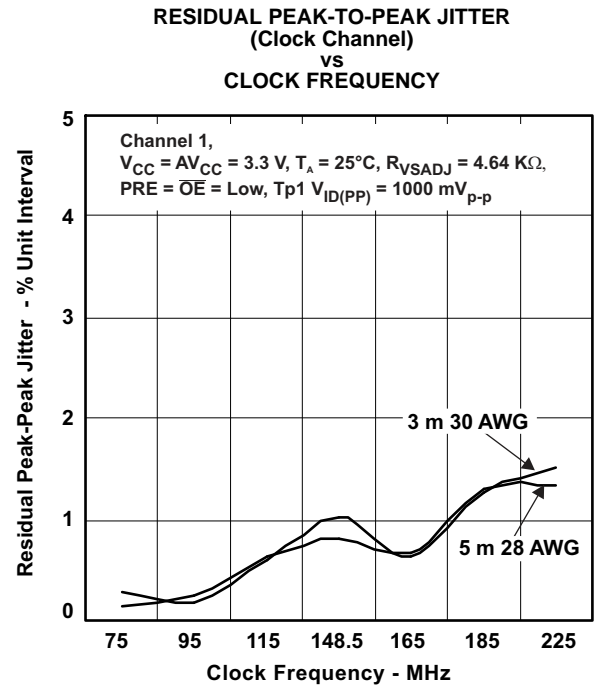
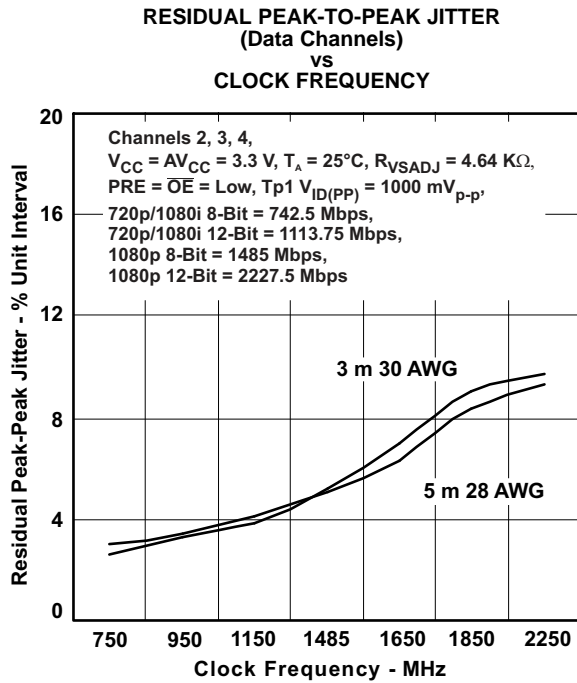

Figure 17.

TYPICAL CHARACTERISTICS (continued)



TYPICAL CHARACTERISTICS (continued)

HDMI Cables Running at 165-MHz Pixel Clock

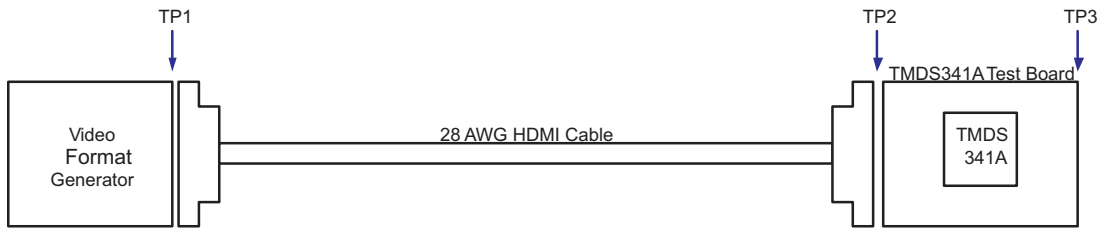

Figure 20. 1-m and 5-m HDMI Cable Test Point Configuration

1-m Cable Length Eye Patterns

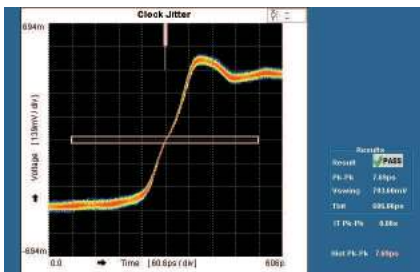

Figure 21. Clock at TP1

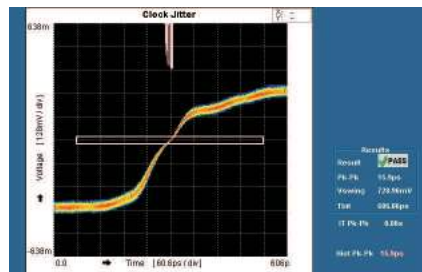

Figure 22. Clock at TP2

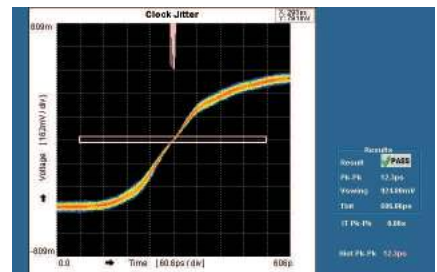

Figure 23. Clock at TP3

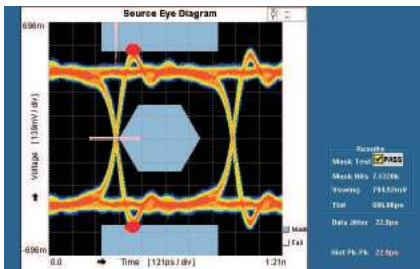

Figure 24. Data at TP1

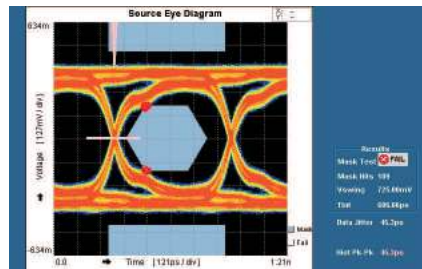

Figure 25. Data at TP2

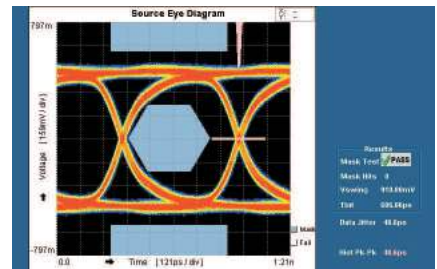

Figure 26. Data at TP3

TYPICAL CHARACTERISTICS (continued)

5-m Cable Length Eye Patterns

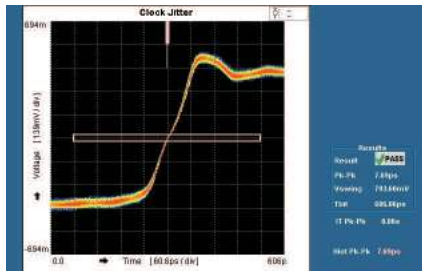

Figure 27. Clock at TP1

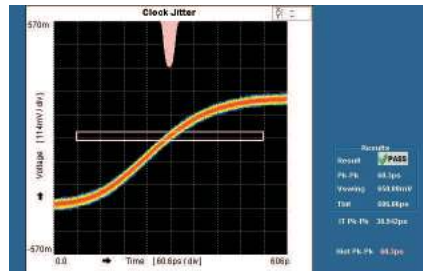

Figure 28. Clock at TP2

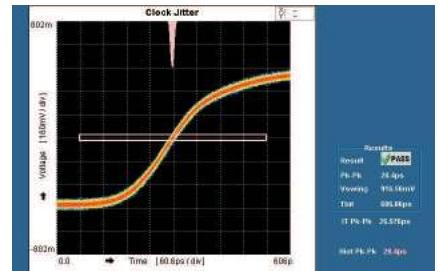

Figure 29. Clock at TP3

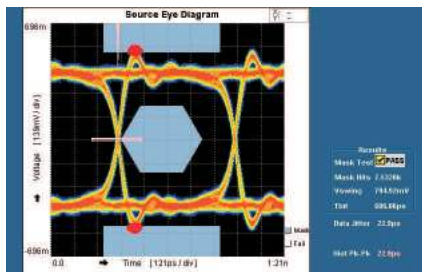

Figure 30. Data at TP1

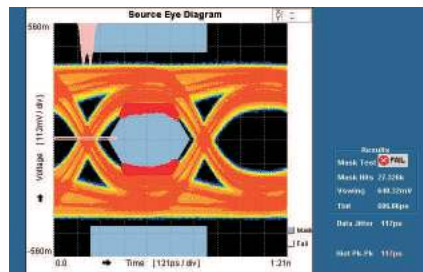

Figure 31. Data at TP2

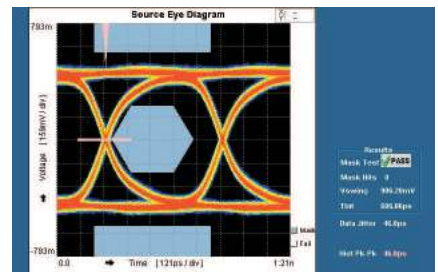

Figure 32. Data at TP3
(DC-Coupled Input)

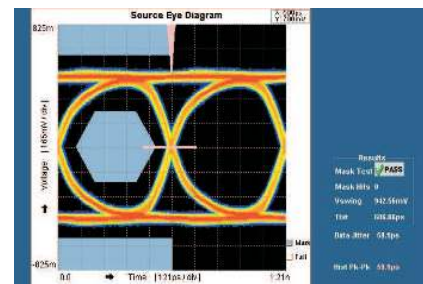

Figure 33. Data at TP3
(AC-Coupled Input)

APPLICATION INFORMATION

Supply Voltage

All V_{CC} pins can be tied to a single 3.3-V power source. A 0.01- μ F capacitor is connected from each V_{CC} pin directly to ground to filter supply noise.

TMDS Inputs

Standard TMDS terminations are integrated on all TMDS inputs. External terminations are not required. Each input channel contains an 8-dB equalization circuit to compensate for cable losses. The voltage at the TMDS input pins must be limited per the absolute maximum ratings. An unused input should not be connected to ground as this would result in excessive current flow damaging the device.

TMDS Input Fail-Safe

TMDS input pins do not incorporate fail-safe circuits. An unused input channel can be externally biased to prevent output oscillation. One pin can be left open with the other grounded through a 1-k Ω resistor as shown in Figure 34.

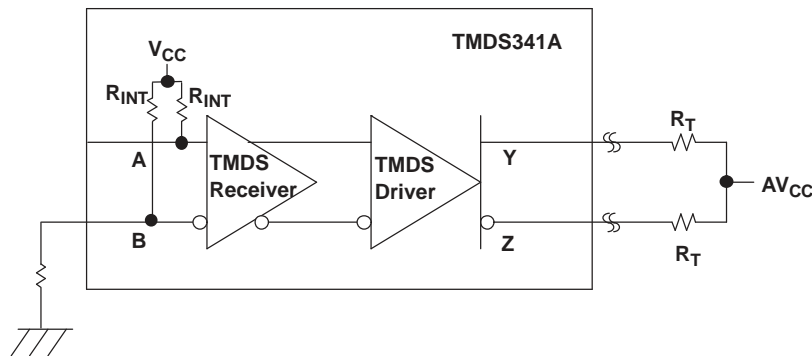

Figure 34. TMDS Input Fail-Safe Recommendation

TMDS Outputs

A 1% precision resistor, 4.64-k Ω , connected from VSADJ to ground is recommended to allow the differential output swing to comply with TMDS signal levels. The differential output driver provides a typical 10-mA current sink capability, which provides a typical 500-mV voltage drop across a 50- Ω termination resistor.

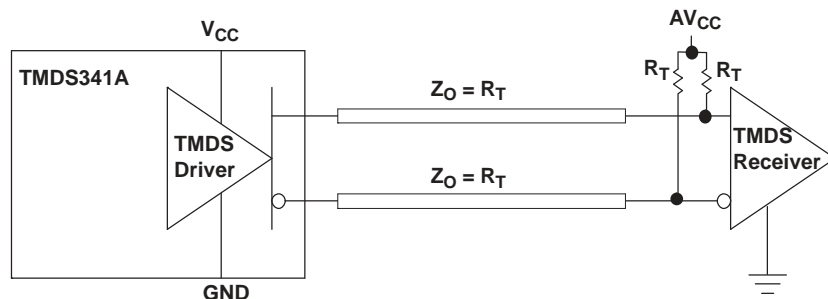

Figure 35. TMDS Driver and Termination Circuit

As shown in Figure 35, if V_{CC} (TMDS341A supply) and AV_{CC} (sink termination supply) are powered, the TMDS output signals are high impedance when \overline{OE} is high. Normal operation is with both supplies active.

Also shown in Figure 35, if V_{CC} is on and AV_{CC} is off, the TMDS outputs source a typical 5-mA current through each termination resistor to ground. The terminations consume a total of 10 mW of power independent of the \overline{OE} logical selection. When AV_{CC} is powered on, normal operation (\overline{OE} controls output impedance) is resumed.

APPLICATION INFORMATION (continued)

When the power source of the device, V_{CC} , is off and the power source to termination, AV_{CC} , is on, the output leakage current ($I_{O(off)}$) specification ensures leakage current is limited to 10- μ A or less.

The PRE pin provides 3-dB de-emphasis, allowing output signal pre-conditioning to offset interconnect losses from the TMDS341A outputs to a TMDS receiver. PRE is recommended to be low to the circuit design of a stand-alone switch box.

HPD Pins

The input of the HPD_SINK is 5-V tolerant, allowing direct connection to 5-V signals. The HPD pin output resistance is 35- Ω typically. A 1-k Ω 10% resistor is recommended to be connected from an HPD pin at the TMDS341A to the HPD pin of the HDMI connector.

DDC Channels

The DDC channels are designed with a bi-directional pass gate, providing 5-V signal tolerance. The 5-V tolerance allows direct connection to a standard I²C bus. The level shifter between 3.3 V and 5 V I²C interface can be eliminated.

Configuring the TMDS341A as a 2:1 Switch

The TMDS341A can be configured as a 2-to-1 switch by pulling the source selector pin (S1, S2, S3) of the non-active port low and leaving the corresponding TMDS inputs, SCL, SDA, and HPD pins open.

Layout Considerations

The high-speed TMDS inputs are the most critical paths for the TMDS341A. There are several considerations to minimize discontinuities on these transmission lines between the connectors and the device:

- Maintain 100- Ω differential transmission line impedance into and out of the TMDS341A
- Keep an uninterrupted ground plane beneath the high-speed I/Os
- Keep the ground-path vias to the device as close as possible to allow the shortest return current path
- Layout of the TMDS differential inputs should be with the shortest stubs from the connectors

Connecting Cables Longer Than 5 m

When using the TMDS341A with cables longer than 5 m, the impact to the TMDS signal path as well as the DDC signal path must be considered.

TMDS Signal Path

The TMDS341A receiver equalization circuit provides the capability of compensating inter-symbol interference (ISI) losses in a 5-m 28-AWG DVI cable. Typical cable measurements indicate that the TMDS341A can drive a 5-m 28-AWG HDMI cable and pass the eye mask at the output of a HDMI source (TP1) and a 10-m 28-AWG HDMI cable and pass the eye mask at the input of a HDMI sink (TP2). [Figure 36](#) through [Figure 39](#) show the eye mask measurement results.

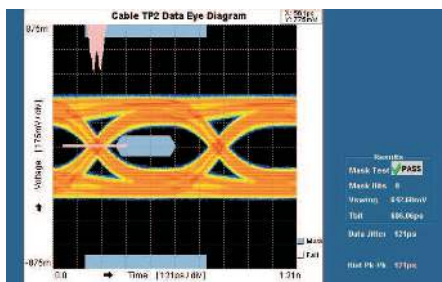

Figure 36. Eye Diagram at Output 5-m 28-AWG Cable vs TP1 Eye Mask

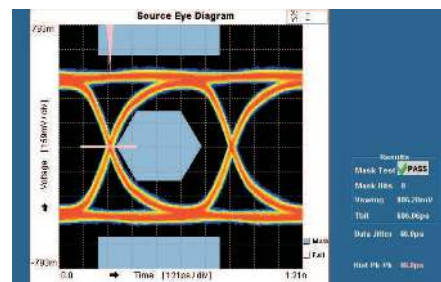

Figure 37. Eye Diagram Recovered by TMDS341A vs TP1 Eye Mask

APPLICATION INFORMATION (continued)

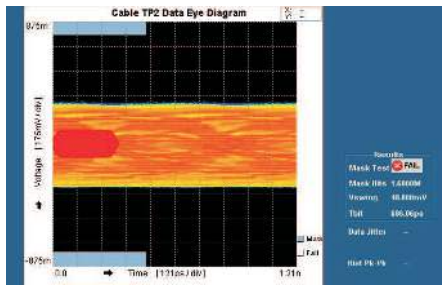

Figure 38. Eye Diagram at Output 10-m 28-AWG Cable vs TP2 Eye Mask

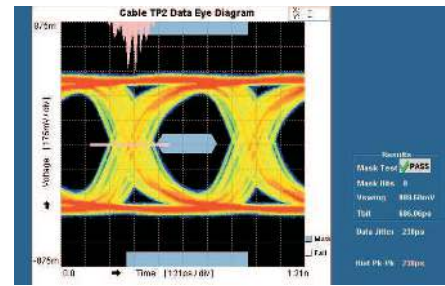

Figure 39. Eye Diagram Recovered by TMDS341A vs TP2 Eye Mask

DDC Signal Path

Observed I²C bus voltage is dependent on bus resistance, capacitance, and time. The transient bus voltage, when charging from a low state to a high state, can be calculated using equation (1).

$$V(t) = V_{DD}(1 - e^{-t/RC}) \tag{1}$$

Where:

- t is the time since the charging started
- V_{DD} is the pull-up termination voltage
- R is the total resistance on the I²C link
- C is the total capacitance on the I²C link

In the I²C bus specification, version 2.1, the high-level threshold voltage is V_{IH} = 0.7 V_{DD}, and the low-level threshold voltage is V_{IL} = 0.3 V_{DD}.

From equation (1), the times to charge from a bus voltage of 0 V to the V_{IH} and V_{IL} levels are:

$$t_{IH} = 1.204 \times RC$$

$$t_{IL} = 0.357 \times RC$$

The bus rise time (from 0.3 V_{DD} to 0.7 V_{DD}) is then given by equation (2):

$$t_{r(30-70)} = t_{IH} - t_{IL} = 0.847 \times RC \tag{2}$$

The TMDS341A can be easily applied in stand-alone switch boxes and digital displays. The following sections show the bus lengths that can be supported in each case.

Maximum Bus Lengths for Switch Applications

Figure 40 shows the TMDS341A being used as a stand-alone switch. Both pull-up resistors are decided by the source and sink equipment. A 1.5-kΩ resistor at the source and a 47-kΩ resistor at the sink are recommended.

APPLICATION INFORMATION (continued)

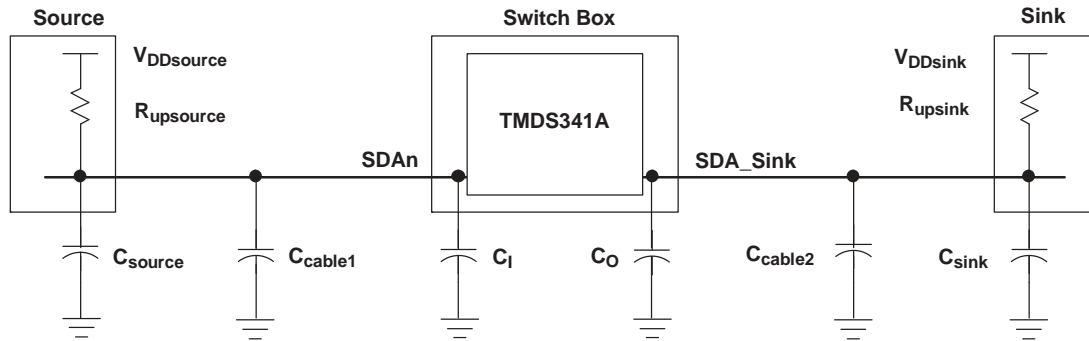

Figure 40. DDC Link from Source to Sink With External Switch Box

$$R_{\text{upsource}} = 1.5\text{-k}\Omega \text{ pull-up to } 5 \text{ V}$$

$$R_{\text{upsink}} = 47\text{-k}\Omega \text{ pull-up to } 5 \text{ V}$$

$$R_{\text{total}} = R_{\text{upsource}} \parallel R_{\text{upsink}} = 1.45 \text{ k}\Omega$$

$$C_{\text{total}} = C_{\text{source}} \parallel C_{\text{cable1}} \parallel C_i \parallel C_o \parallel C_{\text{cable2}} \parallel C_{\text{sink}}$$

For standard mode I²C, the frequency is at 100 kHz, and the transition time must be less than 1 μ s. The total allowable capacitance, C_{total} , is then 814-pF. C_{source} and C_{sink} are limited by the HDMI specification to 50 pF. $C_{i/o}$ for the TMDS341A is 10 pF max. The total capacitance from DVI or HDMI cables, C_{cable1} and C_{cable2} , should then be less than 704 pF.

Typical capacitance is 200 pF for a 28-AWG 5-m HDMI cable and 300 pF for a 28-AWG 5-m DVI cable. The recommended total cable length is the length of cable 1, L_{cable1} , plus the length of cable 2, L_{cable2} . For a 28-AWG DVI cable, the total cable length is 11 m; and for a 28-AWG HDMI cable, the total cable length is 17 m.

This calculation is applicable to $V_{\text{IH}} \leq V_{\text{pass}}$.

Maximum Bus Lengths for DTV Applications

Figure 41 shows the TMDS341A being used as a switch in a DTV and being placed on the same PCB board as the DVI/HDMI receiver. Unlike Figure 40, the output connector of the TMDS341A stand-alone switch and the input connector of the sink are removed, which results in a lower capacitance in the DDC link and eliminates the impedance discontinuity. However, the capacitance of the removed connectors is relatively small, relative to the total allowable capacitance. The results from the previous section *Maximum Bus Lengths for Switch Applications* can be reused if the pull-up resistors and capacitances have the same values. The recommended total cable length is the length from source to sink.

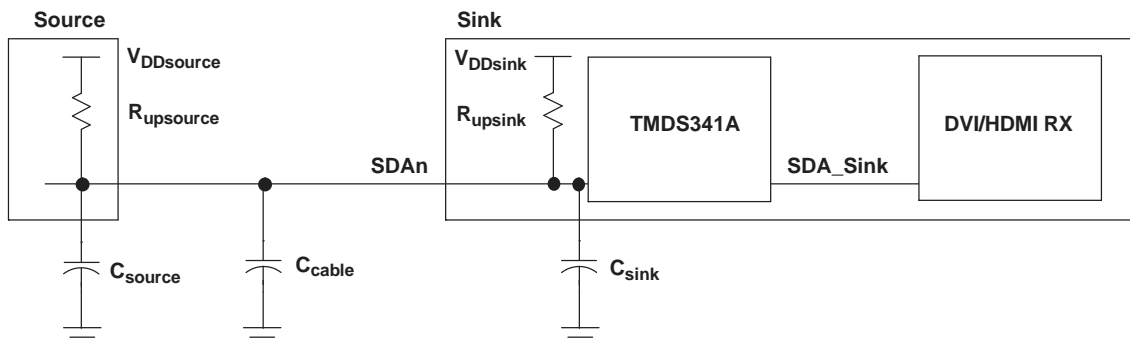

Figure 41. DDC Link From Source to Sink Without External Switch Box

APPLICATION INFORMATION (continued)

[Table 2](#) summarizes the recommended cable lengths based on threshold voltages $V_{IH} = 0.7 V_{DD}$ and $V_{IL} = 0.3 V_{DD}$.

Table 2. Recommended Cable Lengths Under General Threshold Voltages, $0.7 V_{DD}$ and $0.3 V_{DD}$, of a DDC Interface

DDC THRESHOLD VOLTAGE, $V_{IH} = 0.7 V_{DD}$, $V_{IL} = 0.3 V_{DD}$		TOTAL CABLE LENGTH (m)	
SUGGESTED PULL-UP RESISTANCE (k Ω)	CABLE TYPE	SWITCH BOX $L_{cable1} + L_{cable2}$	DIGITAL DISPLAY L_{cable}
$R_{upsource} = 1.5 \text{ k}\Omega$ $R_{upsink} = 47 \text{ k}\Omega$	28-AWG DVI	11	11
	28-AWG HDMI	17	17

Applying the same methodology to the case of $V_{IH} = 1.9 \text{ V}$ and $V_{IL} = 0.7 \text{ V}$, [Table 3](#) summarizes the recommended cable lengths to meet the timing requirement of the DDC interface.

Table 3. Recommended Cable Lengths Under General Threshold Voltages, 1.9 V and 0.7 V , of a DDC Interface

DDC THRESHOLD VOLTAGE, $V_{IH} = 1.9 \text{ V}$, $V_{IL} = 0.7 \text{ V}$		TOTAL CABLE LENGTH (m)	
SUGGESTED PULL-UP RESISTANCE (k Ω)	CABLE TYPE	SWITCH BOX $L_{cable1} + L_{cable2}$	DIGITAL DISPLAY L_{cable}
$R_{upsource} = 1.5 \text{ k}\Omega$ $R_{upsink} = 47 \text{ k}\Omega$	28-AWG DVI	16	16
	28-AWG HDMI	24	24

Revision History

NOTE: Page numbers for previous revisions may differ from page numbers in the current version.

Changes from A Revision (November 2006) to B Revision	Page
• Changed signaling rate from 1.65 Gbps to 2.25 Gbps and color depth from 8-bit to 12-bit	1
• Changed 1.65 Gbps to 2.25 Gbps	1
• Changed from 1.65 Gbps to 2.25 Gbps.....	7
• Added data channels residual peak-to-peak jitter curves	16
• Added clock channel residual peak-to-peak jitter curves	16
• Added A to the device on test board	17

PACKAGING INFORMATION

Orderable Device	Status (1)	Package Type	Package Drawing	Pins	Package Qty	Eco Plan (2)	Lead finish/ Ball material (6)	MSL Peak Temp (3)	Op Temp (°C)	Device Marking (4/5)	Samples
TMDS341APFC	ACTIVE	TQFP	PFC	80	96	RoHS & Green	NIPDAU	Level-3-260C-168 HR	0 to 70	TMDS341A	Samples
TMDS341APFCR	ACTIVE	TQFP	PFC	80	1000	RoHS & Green	NIPDAU	Level-3-260C-168 HR	0 to 70	TMDS341A	Samples

(1) The marketing status values are defined as follows:

ACTIVE: Product device recommended for new designs.

LIFEBUY: TI has announced that the device will be discontinued, and a lifetime-buy period is in effect.

NRND: Not recommended for new designs. Device is in production to support existing customers, but TI does not recommend using this part in a new design.

PREVIEW: Device has been announced but is not in production. Samples may or may not be available.

OBSOLETE: TI has discontinued the production of the device.

(2) **RoHS:** TI defines "RoHS" to mean semiconductor products that are compliant with the current EU RoHS requirements for all 10 RoHS substances, including the requirement that RoHS substance do not exceed 0.1% by weight in homogeneous materials. Where designed to be soldered at high temperatures, "RoHS" products are suitable for use in specified lead-free processes. TI may reference these types of products as "Pb-Free".

RoHS Exempt: TI defines "RoHS Exempt" to mean products that contain lead but are compliant with EU RoHS pursuant to a specific EU RoHS exemption.

Green: TI defines "Green" to mean the content of Chlorine (Cl) and Bromine (Br) based flame retardants meet JS709B low halogen requirements of <=1000ppm threshold. Antimony trioxide based flame retardants must also meet the <=1000ppm threshold requirement.

(3) MSL, Peak Temp. - The Moisture Sensitivity Level rating according to the JEDEC industry standard classifications, and peak solder temperature.

(4) There may be additional marking, which relates to the logo, the lot trace code information, or the environmental category on the device.

(5) Multiple Device Markings will be inside parentheses. Only one Device Marking contained in parentheses and separated by a "~" will appear on a device. If a line is indented then it is a continuation of the previous line and the two combined represent the entire Device Marking for that device.

(6) Lead finish/Ball material - Orderable Devices may have multiple material finish options. Finish options are separated by a vertical ruled line. Lead finish/Ball material values may wrap to two lines if the finish value exceeds the maximum column width.

Important Information and Disclaimer:The information provided on this page represents TI's knowledge and belief as of the date that it is provided. TI bases its knowledge and belief on information provided by third parties, and makes no representation or warranty as to the accuracy of such information. Efforts are underway to better integrate information from third parties. TI has taken and continues to take reasonable steps to provide representative and accurate information but may not have conducted destructive testing or chemical analysis on incoming materials and chemicals. TI and TI suppliers consider certain information to be proprietary, and thus CAS numbers and other limited information may not be available for release.

In no event shall TI's liability arising out of such information exceed the total purchase price of the TI part(s) at issue in this document sold by TI to Customer on an annual basis.

TAPE AND REEL INFORMATION

QUADRANT ASSIGNMENTS FOR PIN 1 ORIENTATION IN TAPE

*All dimensions are nominal

Device	Package Type	Package Drawing	Pins	SPQ	Reel Diameter (mm)	Reel Width W1 (mm)	A0 (mm)	B0 (mm)	K0 (mm)	P1 (mm)	W (mm)	Pin1 Quadrant
TMDS341APFCR	TQFP	PFC	80	1000	330.0	24.4	15.0	15.0	1.5	20.0	24.0	Q2

TAPE AND REEL BOX DIMENSIONS

*All dimensions are nominal

Device	Package Type	Package Drawing	Pins	SPQ	Length (mm)	Width (mm)	Height (mm)
TMDS341APFCR	TQFP	PFC	80	1000	350.0	350.0	43.0

TRAY

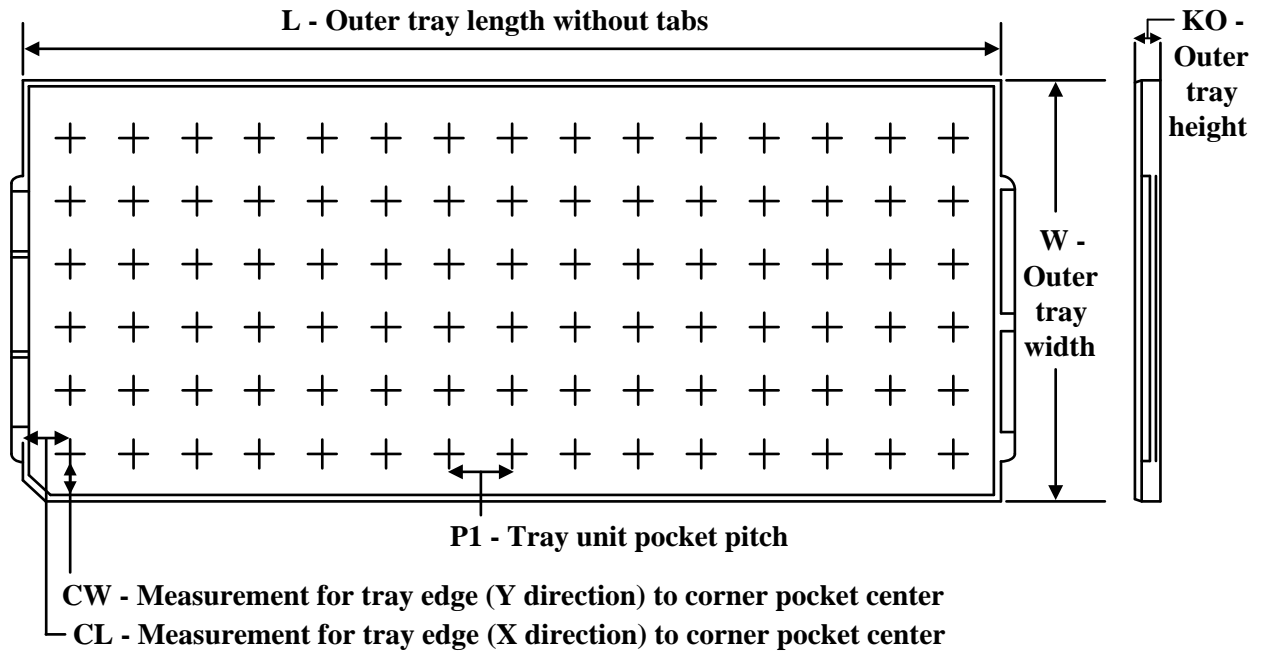

Chamfer on Tray corner indicates Pin 1 orientation of packed units.

*All dimensions are nominal

Device	Package Name	Package Type	Pins	SPQ	Unit array matrix	Max temperature (°C)	L (mm)	W (mm)	K0 (µm)	P1 (mm)	CL (mm)	CW (mm)
TMDS341APFC	PFC	TQFP	80	96	6 x 16	150	315	135.9	7620	18.7	17.25	18.3

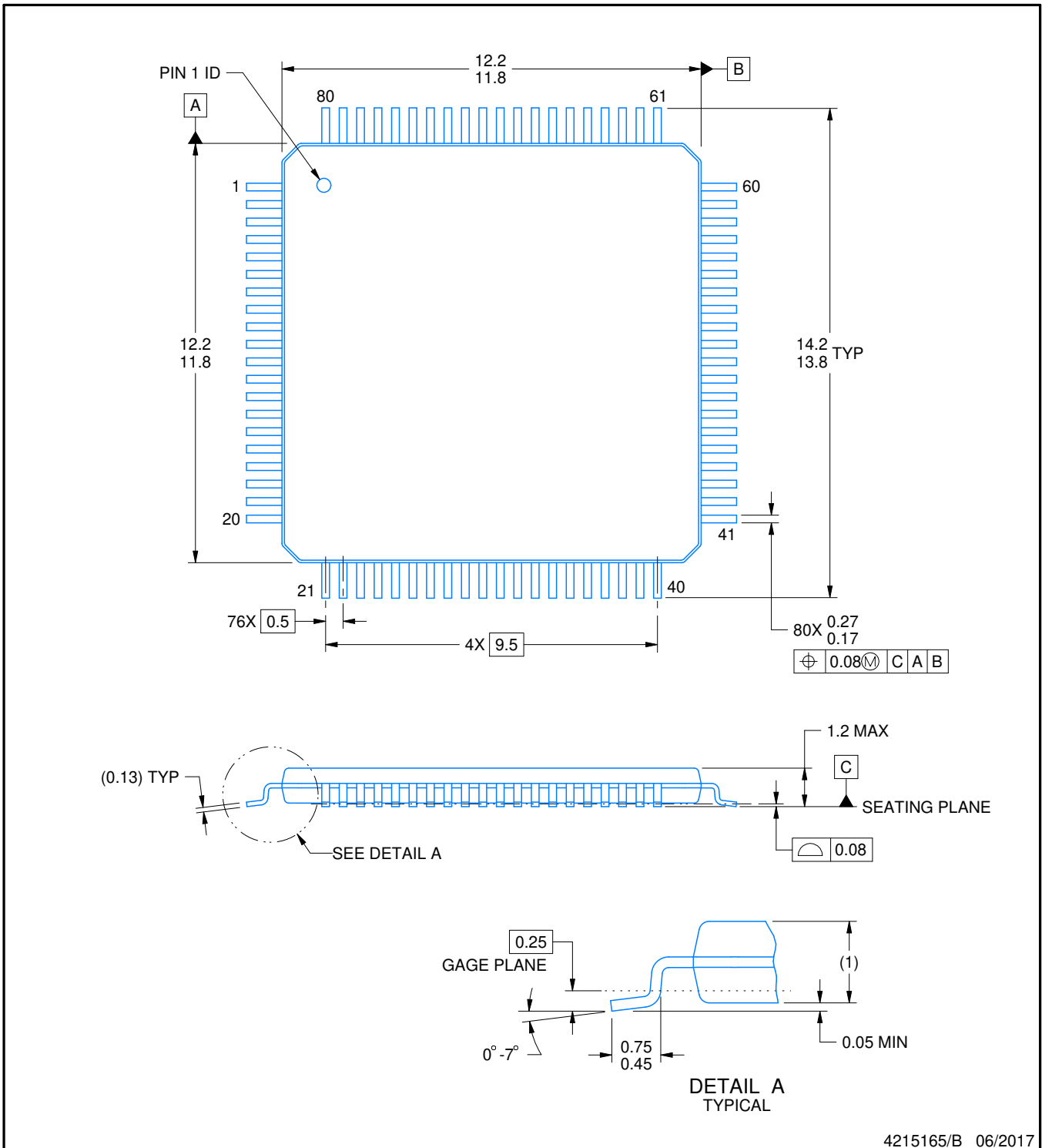
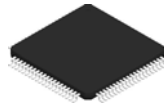

4215165/B 06/2017

NOTES:

1. All linear dimensions are in millimeters. Any dimensions in parenthesis are for reference only. Dimensioning and tolerancing per ASME Y14.5M.
2. This drawing is subject to change without notice.
3. Reference JEDEC registration MS-026.

EXAMPLE BOARD LAYOUT

PFC0080A

TQFP - 1.2 mm max height

PLASTIC QUAD FLATPACK

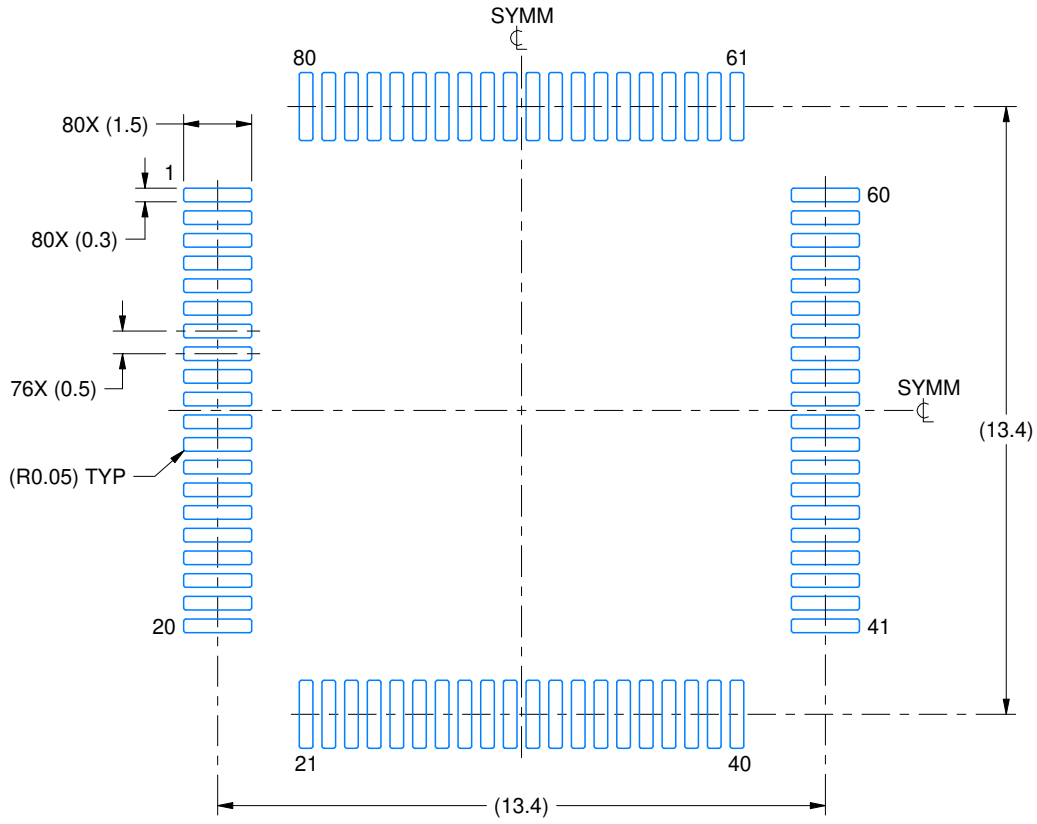

LAND PATTERN EXAMPLE
EXPOSED METAL SHOWN
SCALE:6X

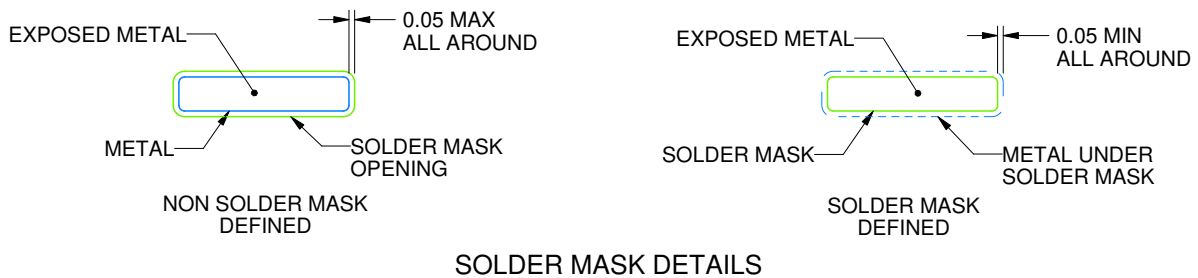

SOLDER MASK DETAILS

4215165/B 06/2017

NOTES: (continued)

4. Publication IPC-7351 may have alternate designs.
5. Solder mask tolerances between and around signal pads can vary based on board fabrication site.
6. For more information, see Texas Instruments literature number SLMA004 (www.ti.com/lit/slma004).

EXAMPLE STENCIL DESIGN

PFC0080A

TQFP - 1.2 mm max height

PLASTIC QUAD FLATPACK

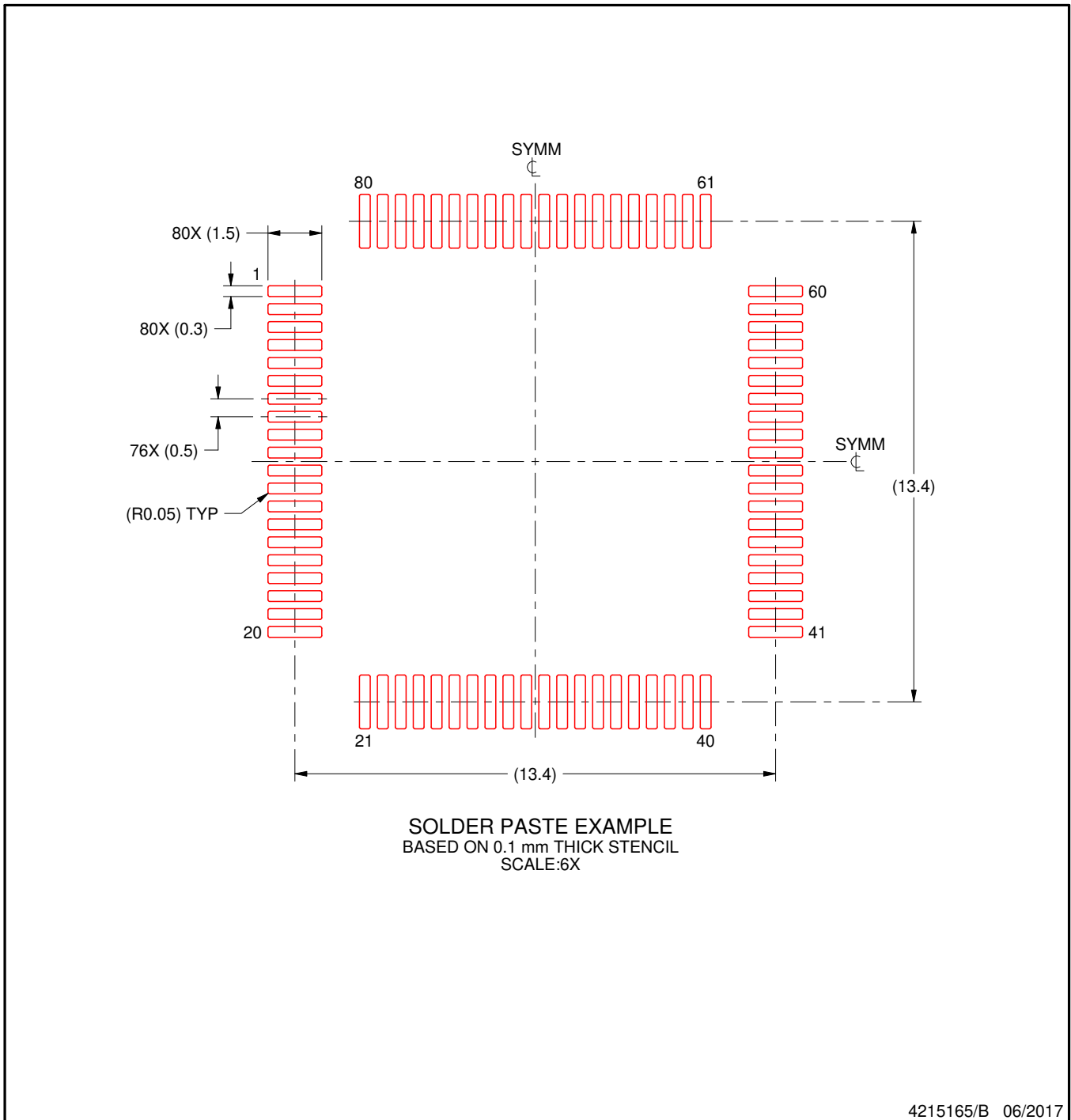

NOTES: (continued)

7. Laser cutting apertures with trapezoidal walls and rounded corners may offer better paste release. IPC-7525 may have alternate design recommendations.
8. Board assembly site may have different recommendations for stencil design.

IMPORTANT NOTICE AND DISCLAIMER

TI PROVIDES TECHNICAL AND RELIABILITY DATA (INCLUDING DATA SHEETS), DESIGN RESOURCES (INCLUDING REFERENCE DESIGNS), APPLICATION OR OTHER DESIGN ADVICE, WEB TOOLS, SAFETY INFORMATION, AND OTHER RESOURCES "AS IS" AND WITH ALL FAULTS, AND DISCLAIMS ALL WARRANTIES, EXPRESS AND IMPLIED, INCLUDING WITHOUT LIMITATION ANY IMPLIED WARRANTIES OF MERCHANTABILITY, FITNESS FOR A PARTICULAR PURPOSE OR NON-INFRINGEMENT OF THIRD PARTY INTELLECTUAL PROPERTY RIGHTS.

These resources are intended for skilled developers designing with TI products. You are solely responsible for (1) selecting the appropriate TI products for your application, (2) designing, validating and testing your application, and (3) ensuring your application meets applicable standards, and any other safety, security, regulatory or other requirements.

These resources are subject to change without notice. TI grants you permission to use these resources only for development of an application that uses the TI products described in the resource. Other reproduction and display of these resources is prohibited. No license is granted to any other TI intellectual property right or to any third party intellectual property right. TI disclaims responsibility for, and you will fully indemnify TI and its representatives against, any claims, damages, costs, losses, and liabilities arising out of your use of these resources.

TI's products are provided subject to [TI's Terms of Sale](#) or other applicable terms available either on ti.com or provided in conjunction with such TI products. TI's provision of these resources does not expand or otherwise alter TI's applicable warranties or warranty disclaimers for TI products.

TI objects to and rejects any additional or different terms you may have proposed.

Mailing Address: Texas Instruments, Post Office Box 655303, Dallas, Texas 75265
Copyright © 2022, Texas Instruments Incorporated