

APPROVED: _____
 DATE: _____ TITLE: _____

Rev	AWO #	Description	Date	Appr
-		RELEASED	11/24/20	
A		UPDATED DRAWING	8/12/22	SS

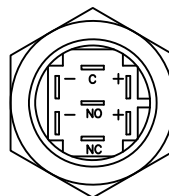
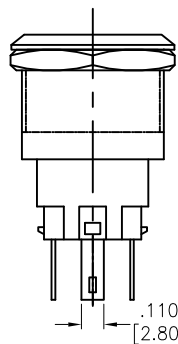
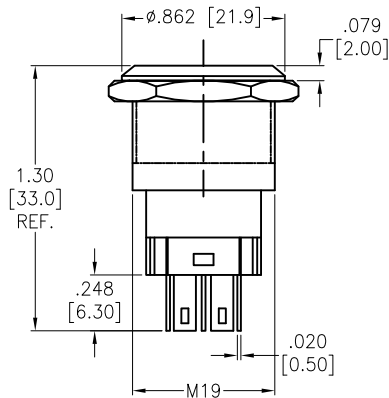
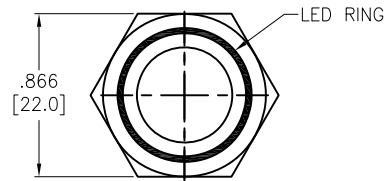
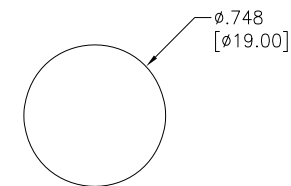
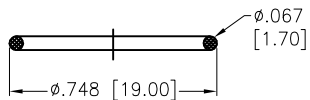
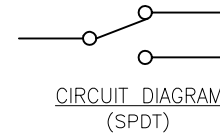

Z= Latching
 S= Momentary

SW-PB2-2EX-A-RX-X-L1A

	LED Color
Blank	Standard Black
W	White
R	Red
G	Green
Y	Yellow (Amber)
B	Blue
O	Orange
S	Silver
RG	Red/Green
RY	Red/Yellow
RB	Red/Blue
RW	Red/White
GB	Green/Blue
RGB	Red/Green/Blue
RGY	Red/Green/Yellow
RGW	Red/Green/White
RBY	Red/Blue/Yellow
RBW	Red/Blue/White

	LED Voltage
1	3V
2	6V
3	12V
4	24V
5	48V
6	110V
7	220V

SPECIFICATIONS:

Material:
 Button: Stainless steel
 Bushing: Copper plated Nickel
 Solder Terminals: Brass
 Electrical:
 Switch Rating: 5A, 250VAC
 Contact resistance: 30 mΩ max
 Insulation resistance: 100 Mohms min (500VDC)
 Dielectric withstanding voltage: 2000 VAC
 Temperature Rating:
 Operating temperature: -25°C to +55°C
 Environmental:
 Lead free, RoHS compliant



UNLESS OTHERWISE SPECIFIED ALL DIMENSIONS ARE INCHES [MM] TOLERANCES: EXCEPT AS NOTED		
INCHES		HOLES
.X ± .10	Ø.X ± .10	
.XX ± .020	Ø.XX ± .015	
.XXX ± .015	Ø.XXX ± .010	
APPROVALS		DATE
DRAWN	OW	11/24/20
CHECKED	AC	11/24/20
APPROVED		



909 Rahway Avenue,
 Union, NJ 07083
 Phone: 908-687-5000
 Fax: 908-687-5710

TITLE SWITCH, PUSH BUTTON, PLASTIC WATERPROOF, SPDT, 1NO-1NC, ILLUMINATED RING, SOLDER TYPE		
SIZE X	PART NO. SW-PB2-2EX-A-RX-X-L1A	REV. A
REF: S00206C	SCALE: NTS	SHEET 1 OF 1