

Printmount Switch Short Stroke 12.7 mm



Printmount Switches  
red

See below:

**Approvals and Compliances**

**Description**

- Switches are possible with different heights
- High-quality gold and silver contacts
- Solder terminals

**Unique Selling Proposition**

- Reliable tactile feedback on input
- Simple assembly
- Long life time

**Weblinks**

[pdf data sheet](#), [html datasheet](#), [General Product Information](#), [CAD-Drawings](#), [Product News](#), [Detailed request for product](#)

**Technical Data**

**Electrical Data**

**Contact Material Silver**

Switching Voltage	max. 48 VDC
Switching current	max. 125 mA
Rated Switching Capacity	2.4 W
Lifetime	> 1 million actuations at Rated Switching Capacity
Contact Resistance	< 50 mΩ < 50 mΩ after lifetime
Insulation Resistance	> 100 MΩ
Duration of Bounce	typ. 0.1 ms

**Contact Material Gold**

Switching Voltage	max. 24 VDC
Switching current	max. 50 mA
Rated Switching Capacity	0.48 W
Lifetime	> 1 million actuations at Rated Switching Capacity
Contact Resistance	< 50 mΩ < 50 mΩ after lifetime
Insulation Resistance	> 100 MΩ
Duration of Bounce	typ. 0.1 ms

**Mechanical Data**

Actuating Force	2.5 ± 0.5 N
Actuating Travel	0.45 ± 0.1 mm
End Stop Strength	> 50 N
Lifetime	> 1 million actuations

**Climatical Data**

Operating Temperature	-25 °C to 85 °C
Storage Temperature	-25 °C to 85 °C
IP-Protection	IP40

**Other Data**

Contact Material	Ag / Au
------------------	---------

**Soldering Data**

Solderability	235 °C / 2 sec (IEC 60068-2-20 Test Ta Method 1)
Resistance to Soldering Heat	260 °C / 5 sec (IEC 60068-2-20 Test Tb Method 1A)

**Material**

Sealing membrane IP67	VMQ
Contact Material Gold	CuZn37 3µm Ni 2 µm Au
Contact Material Silver	CuZn37 2,5 µm Au passivated
Socket	Thermoplastic (PA 66)
Actuator	Thermoplastic (PC)
Elongated Button	Thermoplastic (PC)

**Approvals and Compliances**

Detailed information on product approvals, code requirements, usage instructions and detailed test conditions can be looked up in [Details about Approvals](#)

SCHURTER products are designed for use in industrial environments. They have approvals from independent testing bodies according to national and international standards. Products with specific characteristics and requirements such as required in the automotive sector according to IATF 16949, medical technology according to ISO 13485 or in the aerospace industry can be offered exclusively with customer-specific, individual agreements by SCHURTER.



**Application standards**

Application standards where the product can be used

Organization	Design	Standard	Description
	Suitable for applications acc.	IEC/UL 62368-1	Audio/video, information and communication technology equipment - Part 1: Safety requirements

**Compliances**

The product complies with following Guide Lines

Identification	Details	Initiator	Description
	RoHS	SCHURTER AG	Directive RoHS 2011/65/EU, Amendment (EU) 2015/863
	China RoHS	SCHURTER AG	The law SJ / T 11363-2006 (China RoHS) has been in force since 1 March 2007. It is similar to the EU directive RoHS.
	REACH	SCHURTER AG	On 1 June 2007, Regulation (EC) No 1907/2006 on the Registration, Evaluation, Authorization and Restriction of Chemicals 1 (abbreviated as "REACH") entered into force.

**Dimension [mm]**

Short actuator

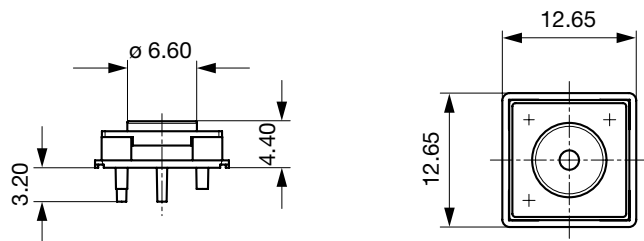

Long actuator

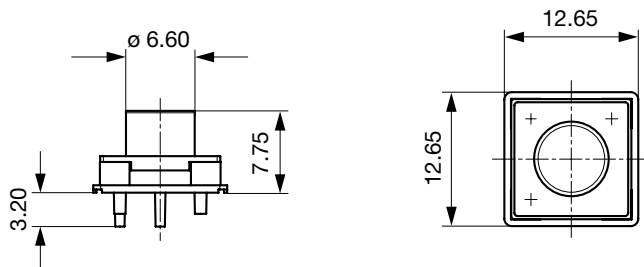

Height variable actuator

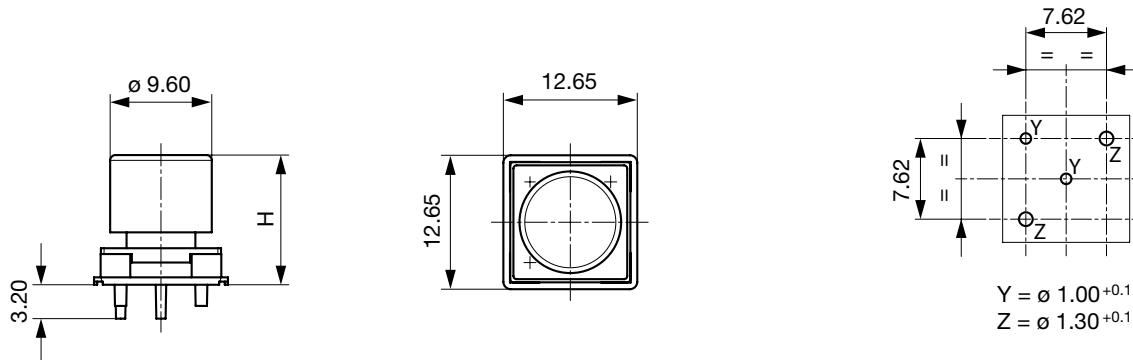

Drilling diagram

**Diagrams**

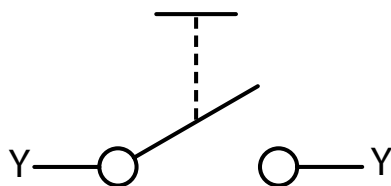

All Variants

Kontakte	Type	Overall height / Color	Overall height <sup>1)</sup> / Color	Bestellnummer
Au	Long actuator	-	-	1241.1022
Au	Height variable	10.75 mm / blue	-	1241.1032.4
Ag	Short actuator	-	-	1241.1052
Ag	Long actuator	-	-	1241.1072
Ag	Height variable	8.50 mm / yellow	-	1241.1082.1
Ag	Height variable	-	14.50 mm / yellow + black	1241.1082.11
Ag	Height variable	9.25 mm / orange	-	1241.1082.2
Ag	Height variable	10.00 mm / red	-	1241.1082.3
Ag	Height variable	10.75 mm / blue	-	1241.1082.4
Ag	Height variable	-	16.75 mm / blue + black	1241.1082.41
Ag	Height variable	11.50 mm / green	-	1241.1082.5
Ag	Height variable	13.75 mm / white	-	1241.1082.8

<sup>1)</sup> Starting with 14.50 mm the heights are achieved with an additional (second) cap of black color

 Most Popular.

Availability for all products can be searched real-time: <https://www.schurter.com/en/Stock-Check/Stock-Check-SCHURTER>

**Packaging unit** 100 pcs