



Main

Range of Product	Telemecanique Photoelectric sensors XU
Series name	General purpose multimode
Electronic sensor type	Photo-electric sensor
Sensor name	XUK
Sensor design	Compact 50 x 50
Detection system	Multimode
Material	Plastic
Type of output signal	Discrete
Supply circuit type	AC/DC
Wiring Technique	5-wire
Discrete output function	1 NO or 1 NC programmable
Electrical connection	Cable
Cable length	16.40 ft (5 m)
Product Specific Application	-
Emission	Infrared diffuse Infrared diffuse with background suppression Infrared thru beam Red polarised reflex
[Sn] nominal sensing distance	13.12 Ft (4 m) polarised reflex need reflector XUZC50 98.43 Ft (30 m) thru beam need a transmitter XUK0ARCTL5T 0.92 Ft (0.28 m) diffuse with background suppression 2.62 ft (0.8 m) diffuse

Complementary

Enclosure Material	PBT
Lens material	PMMA
Maximum sensing distance	114.83 Ft (35 m) thru beam 0.92 Ft (0.28 m) diffuse with background suppression 3.94 Ft (1.2 m) diffuse 18.70 ft (5.7 m) polarised reflex
Output Type	Relay
Add on output	Without, <= 50 mA overload and short-circuit protection
Wire insulation material	PvR
Status LED	1 LED green)supply 1 LED red)instability 1 LED yellow)output state
[Us] rated supply voltage	24...240 V AC 24...240 V DC
Supply voltage limits	20...264 V AC 20...264 V DC
Switching capacity in mA	3 A cos φ = 1 for 0.5 million cycles at 1 operating cycle per second at 250 V)
Switching frequency	<= 20 Hz
Maximum voltage drop	<1.5 V closed state)
Maximum power consumption in W	3 W AC/DC
Time delay range	0...10 s monostable, on-delay or off-delay (programmable)
Maximum delay first up	300 ms
Maximum delay response	25 ms

Maximum delay recovery	25 ms
Setting-up	Self-teaching
Electrical durability	500000 cycles 1 60 cyc/mn 250 V
Depth	1.97 in (50 mm)
Height	1.97 in (50 mm)
Width	0.71 in (18 mm)
Net Weight	0.39 lb(US) (0.175 kg)

Environment

Product Certifications	CE UL CSA
Ambient Air Temperature for Operation	-13...131 °F (-25...55 °C)
Ambient Air Temperature for Storage	-40...158 °F (-40...70 °C)
Vibration resistance	7 gn +/- 1.5 mm 10...55 Hz) IEC 60068-2-6
Shock resistance	30 gn 11 ms) IEC 60068-2-27
IP degree of protection	IP65 double insulation IEC 60529

Ordering and shipping details

Category	22481-SENSORS, PHOTOELECTRIC
Discount Schedule	DS2
GTIN	3389110703184
Nbr. of units in pkg.	1
Package weight(Lbs)	10.86 oz (308.0 g)
Returnability	No
Country of origin	ID

Packing Units

Unit Type of Package 1	PCE
Package 1 Height	1.57 in (4 cm)
Package 1 width	5.12 in (13 cm)
Package 1 Length	5.12 in (13 cm)
Unit Type of Package 2	S02
Number of Units in Package 2	20
Package 2 Weight	15.04 lb(US) (6.821 kg)
Package 2 Height	5.91 in (15 cm)
Package 2 width	11.81 in (30 cm)
Package 2 Length	15.75 in (40 cm)

Offer Sustainability

Sustainable offer status	Green Premium product
California proposition 65	WARNING: This product can expose you to chemicals including: Diisononyl phthalate (DINP), which is known to the State of California to cause cancer, and Di-isodecyl phthalate (DIDP), which is known to the State of California to cause birth defects or other reproductive harm. For more information go to www.P65Warnings.ca.gov
REACH Regulation	REACH Declaration
EU RoHS Directive	Pro-active compliance (Product out of EU RoHS legal scope) EU RoHS Declaration
Mercury free	Yes
RoHS exemption information	Yes
Environmental Disclosure	Product Environmental Profile
Circularity Profile	End Of Life Information

Contractual warranty

Warranty	18 months
----------	-----------

Dimensions

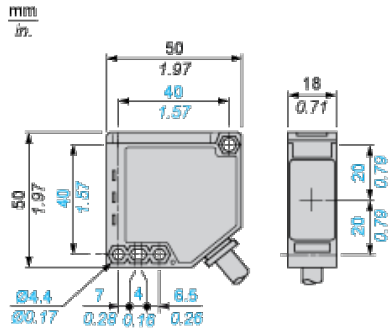

Wiring Schemes

Relay Output

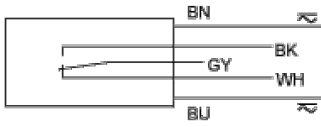

BN : Brown
BU : Blue
BK : Black (NO)
GY : Grey (Relay common)
WH : White (NC)

Detection Curves

With Thru-beam Accessory (Thru-beam)

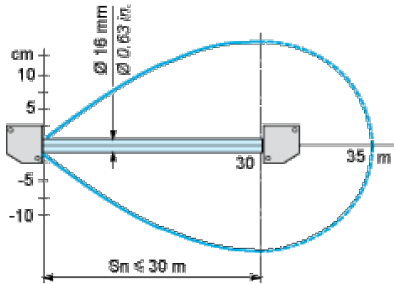

Without Accessory (Diffuse)

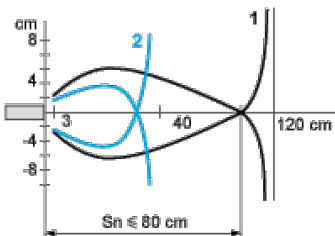

- 1: White 90%
 - 2: Grey 18%
- Object 10 x 10 cm

Without Accessory (Diffuse with background suppression)

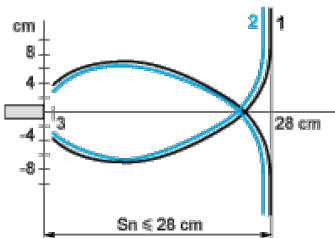

- 1: White 90%
 - 2: Grey 18%
- Object 10 x 10 cm

With reflector (Polarised reflex)

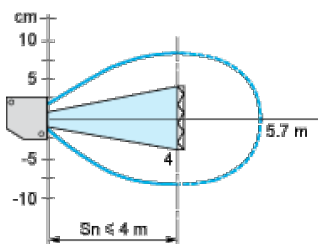

With reflector XUZC50

Variation of Usable Sensing Distance S_u (Without accessory, with adjustable background suppression)

Teach Mode at Minimum

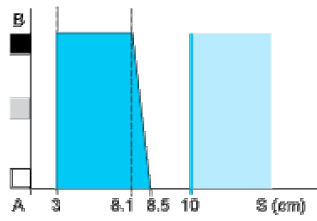

Teach Mode at Maximum

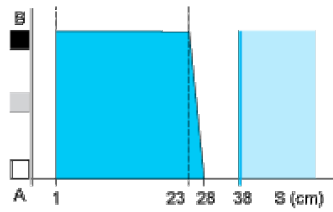

- (1) Black
- (2) Grey
- (3) White
- (4) Sensing range
- (5) Non sensing zone (matt surfaces)

A-B : Object reflection coefficient

- (1) Black 6%
- (2) Grey 18%
- (3) White 90%
- (4) Sensing range
- (5) Non sensing zone (matt surfaces)