

CDST-21/A/C/S-G

Reverse Voltage: 250 Volts

Forward Current: 200 mA

RoHS Device

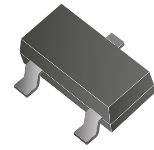

Features

- Fast Switching Speed.
- Surface Mount Package Ideally Suited for Automatic Insertion.
- For General Purpose Switching Applications.
- High Conductance.

Mechanical data

- Case: SOT-23, molded plastic.
- Terminals: solderable per MIL-STD-750, method 2026.
- Approx. weight: 0.008 grams

Circuit diagram

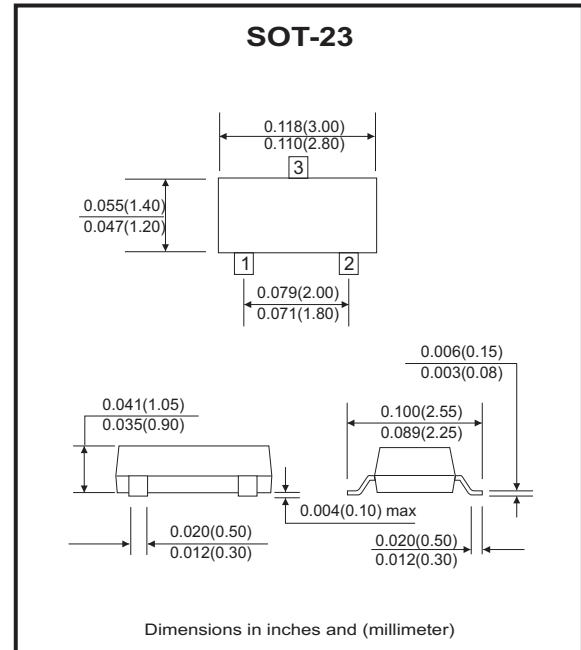
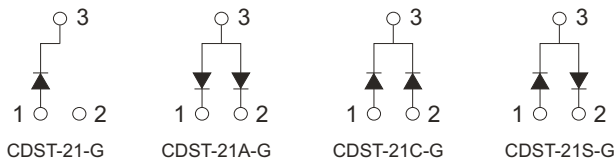

Maximum Ratings and Electrical Characteristics

(at Ta=25°C unless otherwise noted)

Parameter	Symbol	Value	Units	
Repetitive peak reverse voltage	V_{RRM}	250	V	
Working peak reverse voltage	V_{RWM}			
DC blocking voltage	V_R			
Average rectified output current	I_o	200	mA	
Non-repetitive peak forward surge current	I_{FSM}	@ t = 1.0μs	2.5	A
		@ t = 1.0s	0.5	
Repetitive peak forward surge current	I_{FRM}	625	mA	
Power dissipation	P_D	225	mW	
Thermal resistance junction to ambient	$R_{\theta JA}$	55	°C/W	
Junction temperature	T_J	150	°C	
Storage temperature	T_{STG}	-55 to +150	°C	

Company reserves the right to improve product design , functions and reliability without notice.

Electrical Characteristics (at Ta=25°C unless otherwise noted)

Parameter	Conditions	Symbol	Min.	Max.	Unit
Reverse breakdown voltage	$I_R = 100\mu A$	$V_{(BR)}$	250		V
Reverse voltage leakage current	$V_R = 200V$	I_R		0.1	μA
Forward voltage	$I_F = 100mA$ $I_F = 200mA$	V_F		1000 1250	mV
Diode Capacitance	$V_R=0V, f=1MHz$	C_D		5	pF
Reverse recovery time	$I_F=I_R=30mA, I_{rr}=0.1 \times I_R, R_L=100\Omega$	T_{rr}		50	nS

RATING AND CHARACTERISTIC CURVES (CDST-21/A/C/S-G)

Fig.1 - Forward characteristics

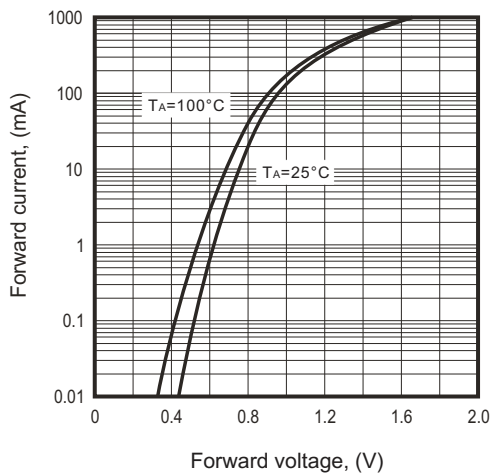

Fig.2 - Reverse characteristics

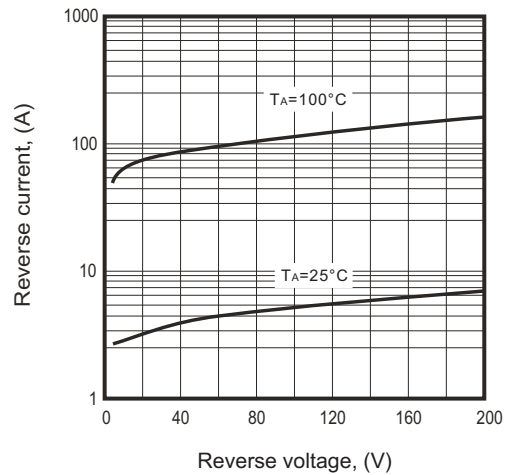

Fig.3 - Capacitance between

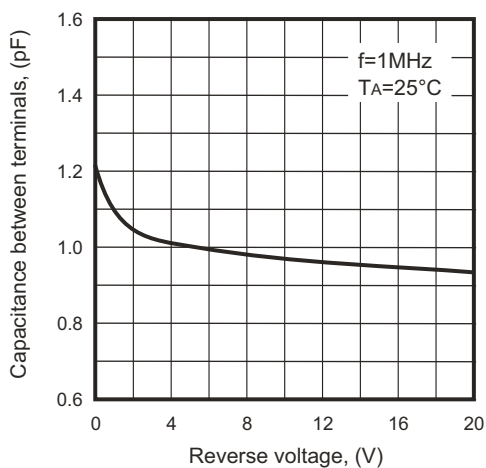
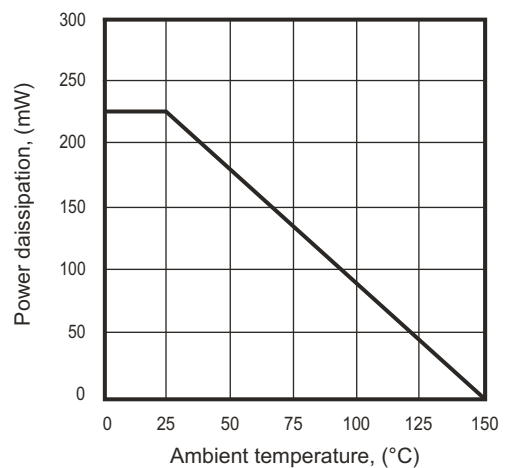
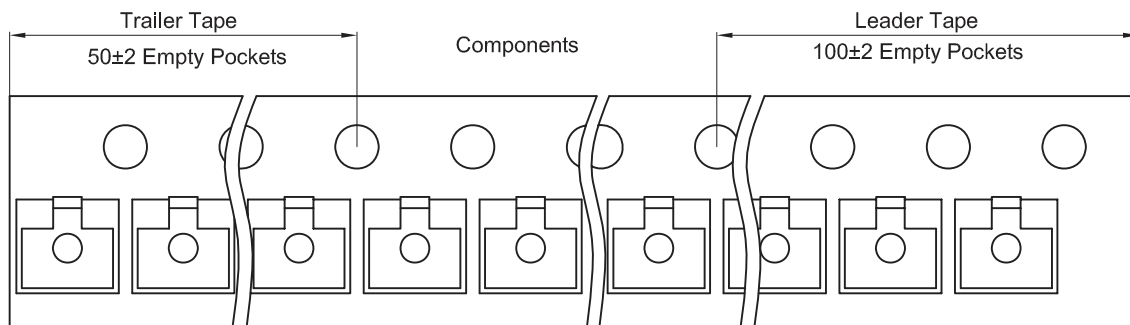
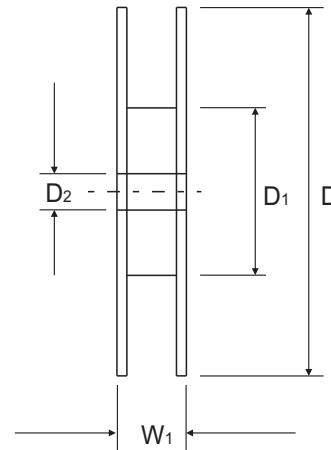
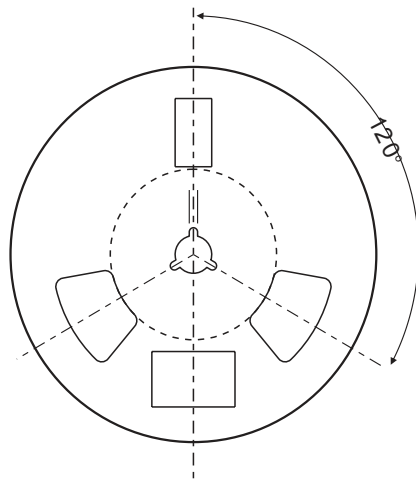
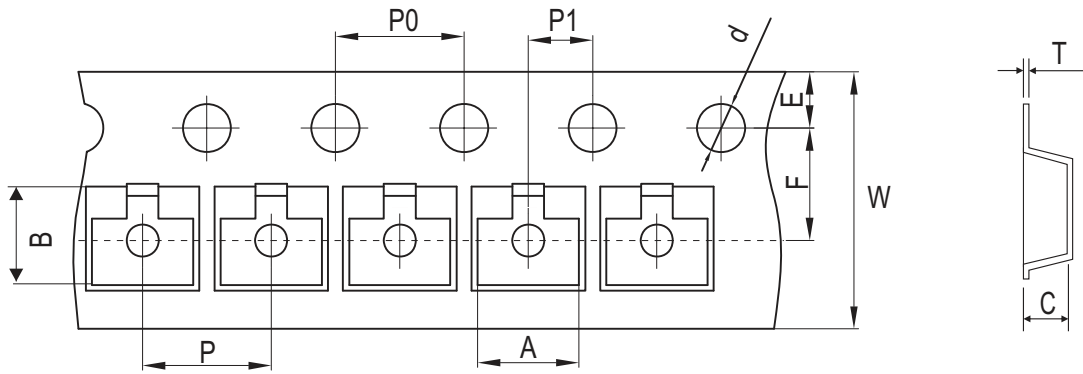

Fig.4 - Power derating curve



Company reserves the right to improve product design , functions and reliability without notice.

Reel Taping Specification



SOT-23	SYMBOL	A	B	C	d	D	D1	D2
	(mm)	3.15 ± 0.10	2.77 ± 0.10	1.22 ± 0.10	Φ1.50 ± 0.10	178 ± 2.00	54.40 ± 1.00	13.00 ± 1.00
	(inch)	0.124 ± 0.004	0.109 ± 0.004	0.048 ± 0.004	Φ0.059 ± 0.004	7.008 ± 0.079	2.142 ± 0.039	0.512 ± 0.039

SOT-23	SYMBOL	E	F	P	P0	P1	W	W1
	(mm)	1.75 ± 0.10	3.50 ± 0.10	4.00 ± 0.10	4.00 ± 0.10	2.00 ± 0.10	8.00 + 0.30 / - 0.10	12.30 ± 1.00
	(inch)	0.069 ± 0.004	0.138 ± 0.004	0.157 ± 0.004	0.157 ± 0.004	0.079 ± 0.004	0.315 + 0.012 / - 0.004	0.484 ± 0.039

Company reserves the right to improve product design, functions and reliability without notice.

REV:C

Marking Code

Part Number	Marking Code
CDST-21-G	JS
CDST-21A-G	JS2
CDST-21C-G	JS3
CDST-21S-G	JS4

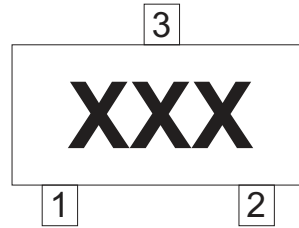

xx/xxx = Product type marking code

Suggested PAD Layout

SIZE	SOT-23	
	(mm)	(inch)
A	0.80	0.031
B	1.90	0.075
C	2.02	0.080
D	2.82	0.111

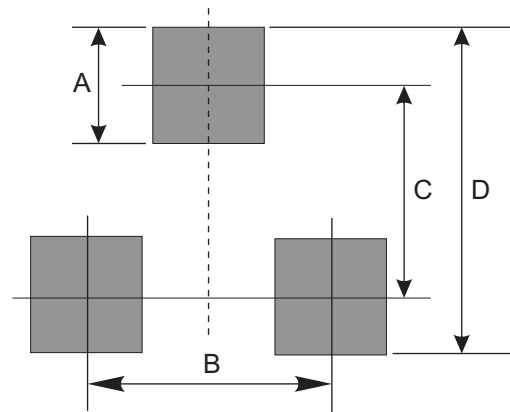

Standard Packaging

Case Type	REEL PACK	
	REEL (pcs)	Reel Size (inch)
SOT-23	3,000	7

Company reserves the right to improve product design , functions and reliability without notice.