

### FEATURES

- High Accuracy:  $\pm 0.8\%$
- Ultralow Dropout Voltage: 120 mV @ 100 mA Typical
- Requires only  $C_O = 0.47 \mu\text{F}$  for Stability
- anyCAP™ = Stable with All Types of Capacitors
- Current and Thermal Limiting
- Low Noise
- Dropout Detector
- Multiple Voltage Options
- Thermally Enhanced SO-8 Package

### APPLICATIONS

- Cellular Telephones
- Notebook and Palmtop Computers
- Battery Powered Systems
- Portable Instruments
- High Efficiency Linear Regulators

ESOL

### GENERAL DESCRIPTION

The ADP3302 is a member of the ADP330X family of precision micropower low dropout anyCAP™ regulators. The ADP3302 contains two fully independent 100 mA regulators with separate shutdown and merged error outputs. It features 1.4% overall output accuracy and very low, 120 mV typical, dropout voltage.

The ADP3302 has a wide input voltage range from +3 V to +12 V. It features an error flag that signals when either of the two regulators is about to lose regulation. It has short circuit current protection as well as thermal shutdown.

The ADP3302's enhanced lead frame design allows for a maximum power dissipation of 630 mW @ +70°C ambient temperature and 1.0 W at room temperature without any external heat sink.

anyCAP™ is a trademark of Analog Devices, Inc.

### FUNCTIONAL BLOCK DIAGRAM

(1/2 IS SHOWN)

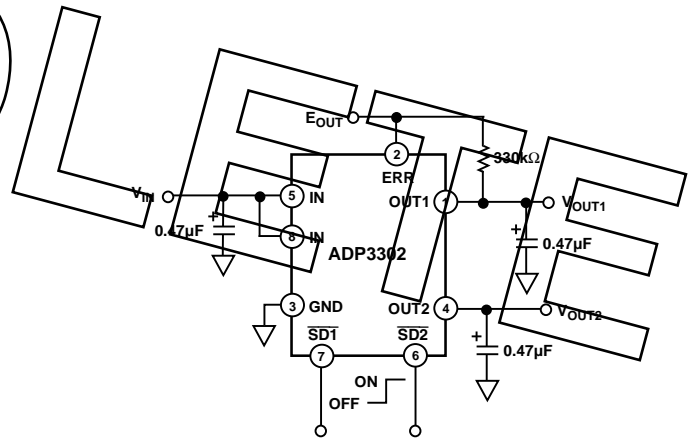
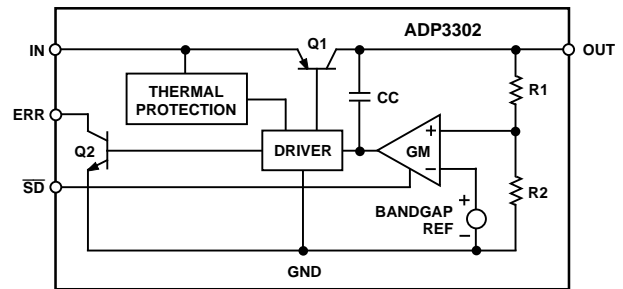

Figure 1. Application Circuit

### REV. 0

Information furnished by Analog Devices is believed to be accurate and reliable. However, no responsibility is assumed by Analog Devices for its use, nor for any infringements of patents or other rights of third parties which may result from its use. No license is granted by implication or otherwise under any patent or patent rights of Analog Devices.

# ADP3302—SPECIFICATIONS (@ $T_A = -20^\circ\text{C}$ to $+85^\circ\text{C}$ , $V_{IN} = 7\text{ V}$ , $C_{IN} = 0.47\ \mu\text{F}$ , $C_{OUT} = 0.47\ \mu\text{F}$ , unless otherwise noted)<sup>1</sup>

Parameter	Symbol	Conditions	Min	Typ	Max	Units
GROUND CURRENT	$I_{\text{GND}}$	$I_{\text{L1}} = I_{\text{L2}} = 100\text{ mA}$		2	4	mA
		$I_{\text{L1}} = I_{\text{L2}} = 0.1\text{ mA}$		0.4	0.8	mA
GROUND CURRENT IN DROPOUT	$I_{\text{GND}}$	$V_{\text{IN}} = 2.5\text{ V}$ $I_{\text{L1}} = I_{\text{L2}} = 0.1\text{ mA}$		1.0	2	mA
DROPOUT VOLTAGE	$V_{\text{DROP}}$	$V_{\text{OUT}} \leq 98\%$ of $V_{\text{O}}$ , Nominal				
		$I_{\text{L}} = 100\text{ mA}$		0.12	0.2	V
		$I_{\text{L}} = 10\text{ mA}$		0.05	0.1	V
		$I_{\text{L}} = 1\text{ mA}$		0.02	0.05	V
SHUTDOWN THRESHOLD	$V_{\text{THSD}}$	ON	2.0	0.9		V
		OFF		0.9	0.3	V
SHUTDOWN PIN INPUT CURRENT	$I_{\text{SDIN}}$	$0 < V_{\text{SD}} < 5\text{ V}$		0	1	$\mu\text{A}$
		$5 \leq V_{\text{SD}} \leq 12\text{ V}$ , @ $V_{\text{IN}} = 12\text{ V}$			22	$\mu\text{A}$
GROUND CURRENT IN SHUTDOWN MODE	$I_{\text{Q}}$	$V_{\text{SD1}} = V_{\text{SD2}} = 0$ , $T_A = +25^\circ\text{C}$ , @ $V_{\text{IN}} = 12\text{ V}$		0	1	$\mu\text{A}$
		$V_{\text{SD1}} = V_{\text{SD2}} = 0$ , $T_A = +85^\circ\text{C}$ , @ $V_{\text{IN}} = 12\text{ V}$			5	$\mu\text{A}$
OUTPUT CURRENT IN SHUTDOWN MODE	$I_{\text{OSD}}$	$T_A = +85^\circ\text{C}$ , @ $V_{\text{IN}} = 12\text{ V}$			12	$\mu\text{A}$
		$T_A = +25^\circ\text{C}$ , @ $V_{\text{IN}} = 12\text{ V}$			2	$\mu\text{A}$
ERROR PIN OUTPUT LEAKAGE	$I_{\text{EL}}$	$V_{\text{EO}} = 5\text{ V}$			13	$\mu\text{A}$
ERROR PIN OUTPUT “LOW” VOLTAGE	$V_{\text{EOL}}$	$I_{\text{SDNK}} = 400\ \mu\text{A}$		0.15	0.3	V
PEAK LOAD CURRENT	$I_{\text{LDPK}}$	$V_{\text{IN}} = \text{Nominal } V_{\text{OUT}} \pm 1\text{ V}$		200		mA
THERMAL REGULATION	$\frac{\Delta V_{\text{O}}}{V_{\text{O}}}$	$V_{\text{IN}} = 12\text{ V}$ , $I_{\text{L}} = 100\text{ mA}$ $T = 10\text{ ms}$		0.05		%/V
OUTPUT NOISE	$V_{\text{NOISE}}$	$f = 10\text{ Hz} - 100\text{ kHz}$ , @ $T_A = +25^\circ\text{C}$				
		$V_{\text{OUT}} = 3.3\text{ V}$ $V_{\text{OUT}} = 5\text{ V}$		75	110	$\mu\text{V rms}$ $\mu\text{V rms}$

## NOTES

<sup>1</sup>Ambient temperature of  $+85^\circ\text{C}$  corresponds to a typical junction temperature of  $+125^\circ\text{C}$ .

Specifications subject to change without notice.

# ADP3302-3.0—SPECIFICATIONS (@ $T_A = -20^\circ\text{C}$ to $+85^\circ\text{C}$ , $V_{IN} = 3.3\text{ V}$ , $C_{IN} = 0.47\ \mu\text{F}$ , $C_{OUT} = 0.47\ \mu\text{F}$ , unless otherwise noted)

Parameter	Symbol	Conditions	Min	Typ	Max	Units
OUTPUT VOLTAGE	$V_{\text{OUT1}}$ or $V_{\text{OUT2}}$	$V_{\text{IN}} = 3.3\text{ V}$ to $12\text{ V}$ $I_{\text{L}} = 0.1\text{ mA}$ to $100\text{ mA}$ $T_A = +25^\circ\text{C}$	2.976	3	3.024	V
		$V_{\text{IN}} = 3.3\text{ V}$ to $12\text{ V}$ $I_{\text{L}} = 0.1\text{ mA}$ to $100\text{ mA}$	2.958	3	3.042	V
LINE REGULATION	$\frac{\Delta V_{\text{O}}}{\Delta V_{\text{IN}}}$	$V_{\text{IN}} = 3.3\text{ V}$ to $12\text{ V}$ $T_A = +25^\circ\text{C}$ , $I_{\text{L}} = 0.1\text{ mA}$		0.024		mV/V
LOAD REGULATION	$\frac{\Delta V_{\text{O}}}{\Delta I_{\text{L}}}$	$I_{\text{L}} = 0.1\text{ mA}$ to $100\text{ mA}$ $T_A = +25^\circ\text{C}$		0.030		mV/mA
CROSS REGULATION	$\frac{\Delta V_{\text{O1}}}{\Delta I_{\text{L2}}}$ or $\frac{\Delta V_{\text{O2}}}{\Delta I_{\text{L1}}}$	$I_{\text{L}} = 0.1\text{ mA}$ to $100\text{ mA}$ $T_A = +25^\circ\text{C}$		1		$\mu\text{V/mA}$

Specifications subject to change without notice.

## ADP3302-3.2—SPECIFICATIONS (@ $T_A = -20^\circ\text{C}$ to $+85^\circ\text{C}$ , $V_{IN} = 3.5\text{ V}$ , $C_{IN} = 0.47\ \mu\text{F}$ , $C_{OUT} = 0.47\ \mu\text{F}$ , unless otherwise noted)

Parameter	Symbol	Conditions	Min	Typ	Max	Units
OUTPUT VOLTAGE	$V_{OUT1}$ or $V_{OUT2}$	$V_{IN} = 3.5\text{ V}$ to $12\text{ V}$ $I_L = 0.1\text{ mA}$ to $100\text{ mA}$ $T_A = +25^\circ\text{C}$	3.174	3.2	3.226	V
		$V_{IN} = 3.5\text{ V}$ to $12\text{ V}$ $I_L = 0.1\text{ mA}$ to $100\text{ mA}$	3.155	3.2	3.245	V
LINE REGULATION	$\frac{\Delta V_O}{\Delta V_{IN}}$	$V_{IN} = 3.5\text{ V}$ to $12\text{ V}$ $T_A = +25^\circ\text{C}$ , $I_L = 0.1\text{ mA}$		0.026		mV/V
LOAD REGULATION	$\frac{\Delta V_O}{\Delta I_L}$	$I_L = 0.1\text{ mA}$ to $100\text{ mA}$ $T_A = +25^\circ\text{C}$		0.032		mV/mA
CROSS REGULATION	$\frac{\Delta V_{O1}}{\Delta I_{L2}}$ or $\frac{\Delta V_{O2}}{\Delta I_{L1}}$	$I_L = 0.1\text{ mA}$ to $100\text{ mA}$ $T_A = +25^\circ\text{C}$		1		$\mu\text{V}/\text{mA}$

Specifications subject to change without notice.

## ADP3302-3.3—SPECIFICATIONS (@ $T_A = -20^\circ\text{C}$ to $+85^\circ\text{C}$ , $V_{IN} = 3.6\text{ V}$ , $C_{IN} = 0.47\ \mu\text{F}$ , $C_{OUT} = 0.47\ \mu\text{F}$ , unless otherwise noted)

Parameter	Symbol	Conditions	Min	Typ	Max	Units
OUTPUT VOLTAGE	$V_{OUT1}$ or $V_{OUT2}$	$V_{IN} = 3.6\text{ V}$ to $12\text{ V}$ $I_L = 0.1\text{ mA}$ to $100\text{ mA}$ $T_A = +25^\circ\text{C}$	3.273	3.3	3.327	V
		$V_{IN} = 3.6\text{ V}$ to $12\text{ V}$ $I_L = 0.1\text{ mA}$ to $100\text{ mA}$	3.253	3.3	3.347	V
LINE REGULATION	$\frac{\Delta V_O}{\Delta V_{IN}}$	$V_{IN} = 3.6\text{ V}$ to $12\text{ V}$ $T_A = +25^\circ\text{C}$ , $I_L = 0.1\text{ mA}$		0.026		mV/V
LOAD REGULATION	$\frac{\Delta V_O}{\Delta I_L}$	$I_L = 0.1\text{ mA}$ to $100\text{ mA}$ $T_A = +25^\circ\text{C}$		0.033		mV/mA
CROSS REGULATION	$\frac{\Delta V_{O1}}{\Delta I_{L2}}$ or $\frac{\Delta V_{O2}}{\Delta I_{L1}}$	$I_L = 0.1\text{ mA}$ to $100\text{ mA}$ $T_A = +25^\circ\text{C}$		1		$\mu\text{V}/\text{mA}$

Specifications subject to change without notice.

## ADP3302-5.0—SPECIFICATIONS (@ $T_A = -20^\circ\text{C}$ to $+85^\circ\text{C}$ , $V_{IN} = 5.3\text{ V}$ , $C_{IN} = 0.47\ \mu\text{F}$ , $C_{OUT} = 0.47\ \mu\text{F}$ , unless otherwise noted)

Parameter	Symbol	Conditions	Min	Typ	Max	Units
OUTPUT VOLTAGE	$V_{OUT1}$ or $V_{OUT2}$	$V_{IN} = 5.3\text{ V}$ to $12\text{ V}$ $I_L = 0.1\text{ mA}$ to $100\text{ mA}$ $T_A = +25^\circ\text{C}$	4.960	5.0	5.040	V
		$V_{IN} = 5.3\text{ V}$ to $12\text{ V}$ $I_L = 0.1\text{ mA}$ to $100\text{ mA}$	4.930	5.0	5.070	V
LINE REGULATION	$\frac{\Delta V_O}{\Delta V_{IN}}$	$V_{IN} = 5.3\text{ V}$ to $12\text{ V}$ $T_A = +25^\circ\text{C}$ , $I_L = 0.1\text{ mA}$		0.04		mV/V
LOAD REGULATION	$\frac{\Delta V_O}{\Delta I_L}$	$I_L = 0.1\text{ mA}$ to $100\text{ mA}$ $T_A = +25^\circ\text{C}$		0.05		mV/mA
CROSS REGULATION	$\frac{\Delta V_{O1}}{\Delta I_{L2}}$ or $\frac{\Delta V_{O2}}{\Delta I_{L1}}$	$I_L = 0.1\text{ mA}$ to $100\text{ mA}$ $T_A = +25^\circ\text{C}$		1		$\mu\text{V}/\text{mA}$

Specifications subject to change without notice.

# ADP3302

## ABSOLUTE MAXIMUM RATINGS\*

Input Supply Voltage	-0.3 V to +16 V
<b>Please note: Pins 5 and 8 should be connected externally for proper operation.</b>	
Shutdown Input Voltage	-0.3 V to +16 V
Error Flag Output Voltage	-0.3 V to +16 V
Power Dissipation	Internally Limited
Operating Ambient Temperature Range	-55°C to +125°C
Operating Junction Temperature Range	-55°C to +125°C
$\theta_{JA}$	96°C/W
$\theta_{JC}$	55°C/W
Storage Temperature Range	-65°C to +150°C
Lead Temperature Range (Soldering 10 sec)	+300°C
Vapor Phase (60 sec)	+215°C
Infrared (15 sec)	+220°C

\*This is a stress rating only; functional operation of the device at these or any other conditions above those indicated in the operation section of this specification is not implied. Exposure to absolute maximum rating conditions for extended periods may affect device reliability.

## PIN FUNCTION DESCRIPTIONS

Pin	Name	Function
1	OUT1	Output of Regulator 1, fixed 3.0 V, 3.2 V, 3.3 V or 5 V output voltage. Sources up to 200 mA. Bypass to ground with a 0.47 $\mu$ F capacitor.
2	ERR	Open Collector Output. Active low indicates that one of the two outputs is about to go out of regulation.
3	GND	Ground Pin.
4	OUT2	Output Regulator 2. Independent of Regulator 1. Fixed 3.0 V, 3.2 V, 3.3 V or 5 V output voltage. Bypass to ground with a 0.47 $\mu$ F capacitor.
5, 8	IN	Regulator Input. Supply voltage can range from +3.0 V to +12 V. <b>Pins 5 and 8 must be connected together for proper operation.</b>
6	$\overline{SD}2$	Active Low Shutdown Pin for Regulator 2. Connect to ground to disable the Out 2 output. When shutdown is not used, this pin should be connected to the input pin.
7	$\overline{SD}1$	Shutdown Pin for Regulator 1, otherwise identical to $\overline{SD}2$ .

## ORDERING GUIDE

Model	Voltage Outputs	Package Option*
ADP3302AR1	OUT 1 3.0 V OUT 2 3.0 V	SO-8
ADP3302AR2	OUT 1 3.2 V OUT 2 3.2 V	SO-8
ADP3302AR3	OUT 1 3.3 V OUT 2 3.3 V	SO-8
ADP3302AR4	OUT 1 3.3 V OUT 2 5.0 V	SO-8
ADP3302AR5	OUT 1 5.0 V OUT 2 5.0 V	SO-8

## PIN CONFIGURATION

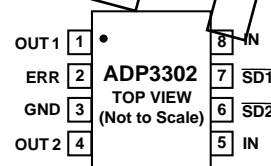

## NOTES

\*SO = Small Outline Package.  
Contact factory for availability of customized options available with mixed output voltages.

## CAUTION

ESD (electrostatic discharge) sensitive device. Electrostatic charges as high as 4000 V readily accumulate on the human body and test equipment and can discharge without detection. Although the ADP3302 features proprietary ESD protection circuitry, permanent damage may occur on devices subjected to high energy electrostatic discharges. Therefore, proper ESD precautions are recommended to avoid performance degradation or loss of functionality.



# Typical Performance Characteristics—ADP3302

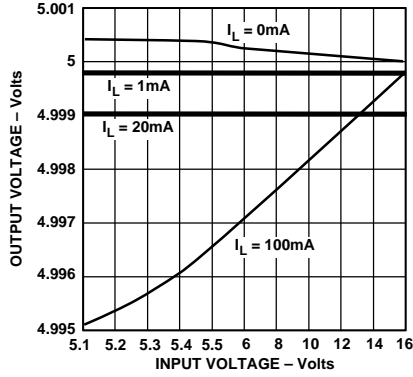

Figure 2. Line Regulation Output Voltage vs. Supply Voltage on ADP3302AR5

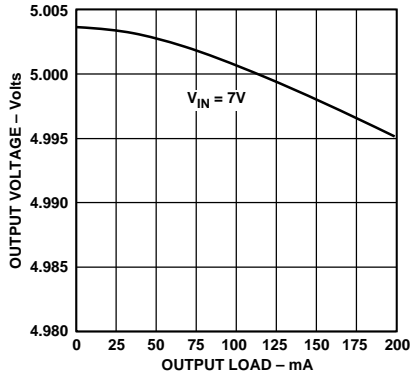

Figure 3. Output Voltage vs. Load Current Up to 200 mA on ADP3302AR5

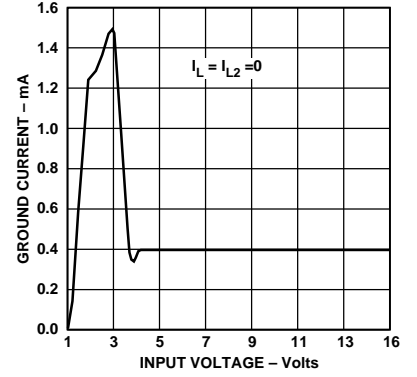

Figure 4. Quiescent Current vs. Supply Voltage—ADP3302AR3

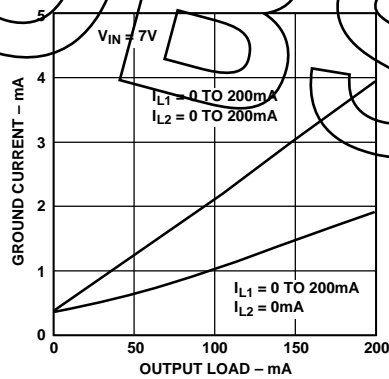

Figure 5. Quiescent Current vs. Load Current

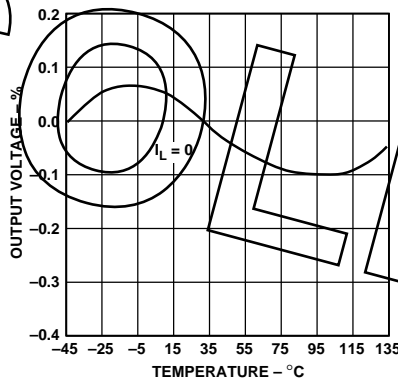

Figure 6. Output Voltage Variation % vs. Temperature

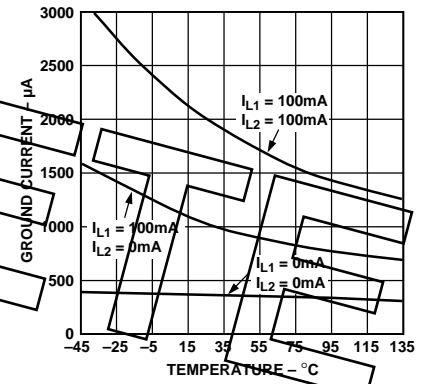

Figure 7. Quiescent Current vs. Temperature

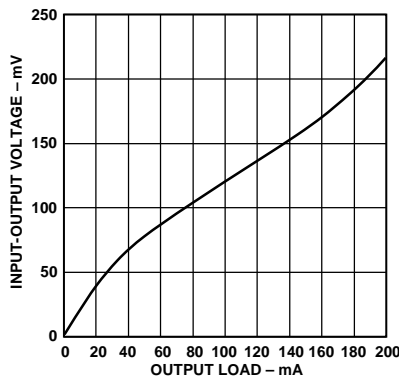

Figure 8. Dropout Voltage vs. Output Current

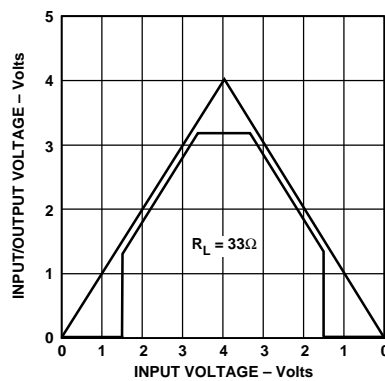

Figure 9. Power-Up/Power-Down on ADP3302AR3.  $\overline{SD} = 3V$  or  $V_{IN}$

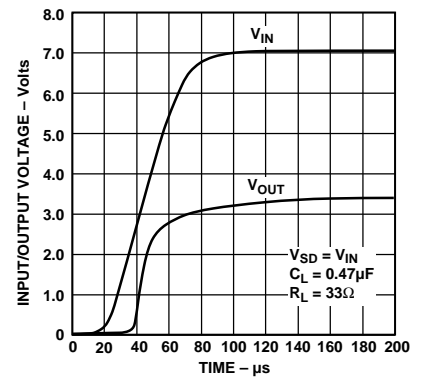

Figure 10. Power-Up Transient on ADP3302AR1

# ADP3302—Typical Performance Characteristics

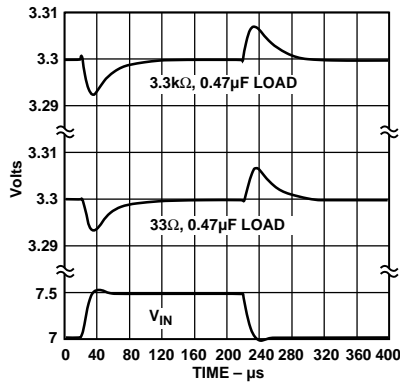

Figure 11. Line Transient Response—(0.47  $\mu$ F Load) on ADP3302AR4

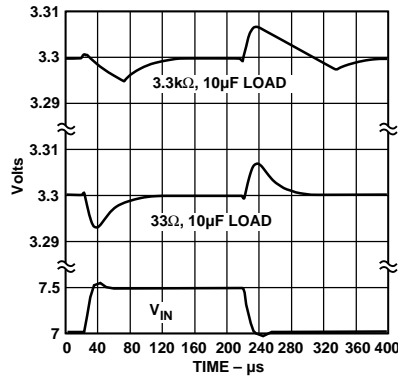

Figure 12. Line Transient Response (10  $\mu$ F Load) on ADP3302AR4

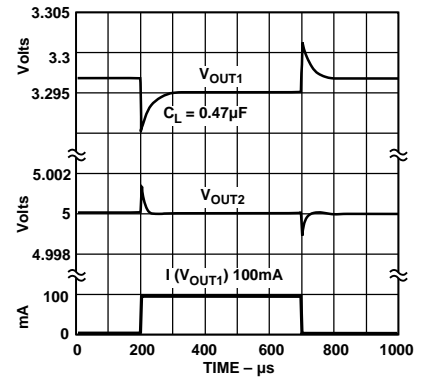

Figure 13. Load Transient on  $V_{OUT1}$  and Crosstalk of  $V_{OUT2}$  on ADP3302AR4 for 1 mA to 100 mA Pulse

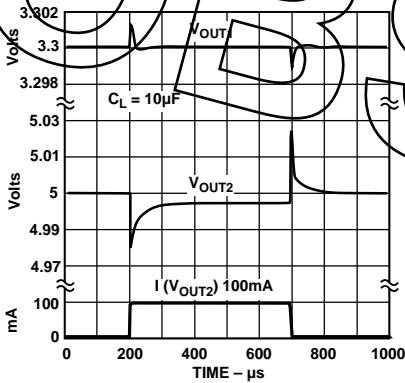

Figure 14. Load Transient on  $V_{OUT2}$  and Crosstalk on  $V_{OUT1}$  on ADP3302AR4 for 1 mA to 100 mA Pulse

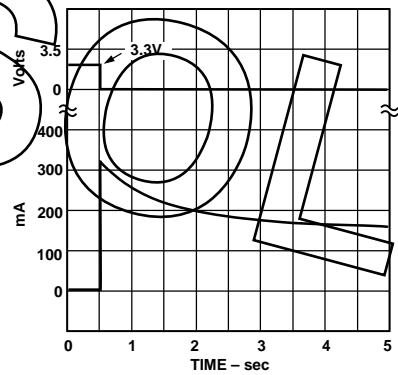

Figure 15. Short Circuit Current

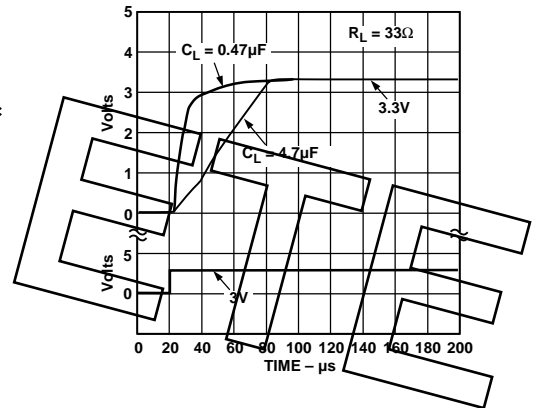

Figure 16. Turn On ADP3302AR3

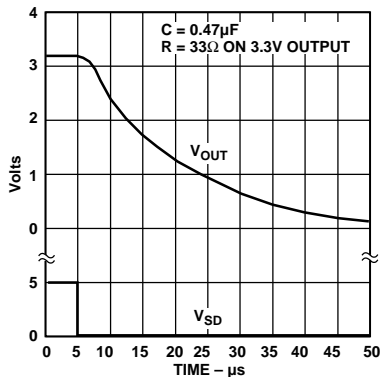

Figure 17. Turn Off on ADP3302AR3

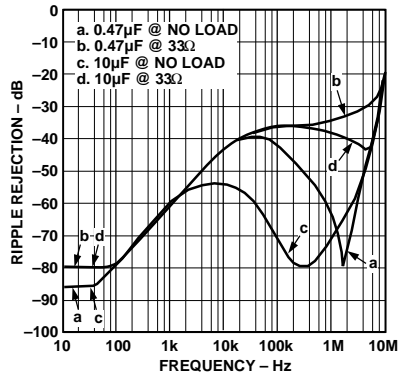

Figure 18. Power Supply Ripple Rejection on ADP3302AR3

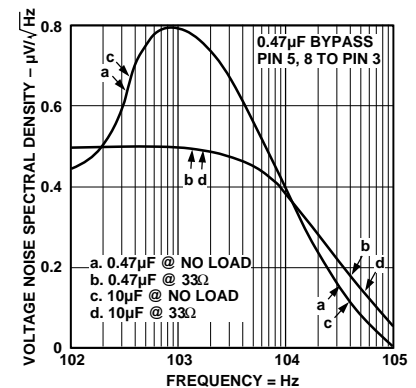

Figure 19. Output Noise Density on ADP3302AR5

## APPLICATION INFORMATION

### anyCAP™

The ADP3302 is an easy to use dual low dropout voltage regulator. The ADP3302 requires only a very small 0.47  $\mu\text{F}$  bypass capacitor on the outputs for stability. Unlike the conventional LDO designs, the ADP3302 is stable with virtually any type of capacitors (anyCAP™) independent of the capacitor's ESR (Effective Series Resistance) value.

### Capacitor Selection

Output Capacitors: As with any micropower device, output transient response is a function of the output capacitance. The ADP3302 is stable with a wide range of capacitor values, types and ESR (anyCAP™). A capacitor as low as 0.47  $\mu\text{F}$  is all that is needed for stability. However, larger capacitors can be used if high output current surges are anticipated. The ADP3302 is stable with extremely low ESR capacitors ( $\text{ESR} \approx 0$ ), such as multilayer ceramic capacitors (MLCC) or OSCON.

Input Bypass Capacitor: An input bypass capacitor is not required. However, for applications where the input source is high impedance or far from the input pins, a bypass capacitor is recommended. Connecting a 0.47  $\mu\text{F}$  capacitor from the input pins (Pins 5 and 8) to ground reduces the circuit's sensitivity to PCB board layout.

Low ESR capacitors offer better performance on a noisy supply; however, for less demanding requirements a standard tantalum or aluminum electrolytic capacitor is adequate.

### Thermal Overload Protection

The ADP3302 is protected against damage due to excessive power dissipation by its thermal overload protection circuit, which limits the die temperature to a maximum of 165°C. Under extreme conditions (i.e., high ambient temperature and power dissipation) where die temperature starts to rise above 165°C, the output current is reduced until the die temperature has dropped to a safe level. The output current is restored when the die temperature is reduced.

Current and thermal limit protections are intended to protect the device against accidental overload conditions. For normal operation, device power dissipation should be externally limited so that junction temperatures will not exceed 125°C.

### Calculating Junction Temperature

Device power dissipation is calculated as follows:

$$PD = (V_{IN} - V_{OUT1}) I_{LOAD1} + (V_{IN} - V_{OUT2}) I_{LOAD2} + (V_{IN}) I_{GND}$$

Where  $I_{LOAD1}$  and  $I_{LOAD2}$  are Load currents on Outputs 1 and 2,  $I_{GND}$  is ground current,  $V_{IN}$  and  $V_{OUT}$  are input and output voltages respectively.

Assuming  $I_{LOAD1} = I_{LOAD2} = 100 \text{ mA}$ ,  $I_{GND} = 2 \text{ mA}$ ,  $V_{IN} = 7.2 \text{ V}$  and  $V_{OUT1} = V_{OUT2} = 5.0 \text{ V}$ , device power dissipation is:

$$PD = (7.2 \text{ V} - 5 \text{ V}) 100 \text{ mA} + (7.2 \text{ V} - 5 \text{ V}) 100 \text{ mA} + (7.2 \text{ V}) 2 \text{ mA} = 0.454 \text{ W}$$

The proprietary thermal coastline lead frame used in the ADP3302 yields a thermal resistance of 96°C/W, which is significantly lower than a standard 8-pin SOIC package at 170°C/W.

Junction temperature above ambient temperature will be approximately equal to:

$$0.454 \text{ W} \times 96^\circ\text{C/W} = 43.6^\circ\text{C}$$

To limit the maximum junction temperature to 125°C, maximum ambient temperature must be lower than:

$$T_{A_{MAX}} = 125^\circ\text{C} - 43.6^\circ\text{C} = 81.4^\circ\text{C}$$

### PRINTED CIRCUIT BOARD LAYOUT CONSIDERATION

All surface mount packages rely on the traces of the PC board to conduct heat away from the package.

In standard packages the dominant component of the heat resistance path is the plastic between the die attach pad and the individual leads. In typical thermally enhanced packages one or more of the leads are fused to the die attach pad, significantly decreasing this component. However, to make the improvement meaningful, a significant copper area on the PCB has to be attached to these fused pins.

The ADP3302's patented thermal coastline lead frame design uniformly minimizes the value of the dominant portion of the thermal resistance. It ensures that heat is conducted away by all pins of the package. This yields a very low 96°C/W thermal resistance for an SO-8 package, without any special board layout requirements, relying just on the normal traces connected to the leads. The thermal resistance can be decreased by, approximately, an additional 10% by attaching a few square cm of copper area to the two  $V_{IN}$  pins of the ADP3302 package.

It is not recommended to use solder mask or silkscreen on the PCB traces adjacent to the ADP3302 pins since it will increase the junction to ambient thermal resistance of the package.

### Shutdown Mode

Applying a TTL high signal to the shutdown pin or tying it to the input pin will turn the output ON. Pulling the shutdown pin down to a TTL low signal or tying it to ground will turn the output OFF. Outputs are independently controlled. In shutdown mode, quiescent current is reduced to less than 2  $\mu\text{A}$ .

### Error Flag Dropout Detector

The ADP3302 will maintain its output voltage over a wide range of load, input voltage and temperature conditions. If regulation is lost, for example, by reducing the supply voltage below the combined regulated output and dropout voltages, the ERRor flag will be activated. The ERR output is an open collector, which will be driven low.

Once set, the ERRor flag's hysteresis will keep the output low until a small margin of operating range is restored, either by raising the supply voltage or reducing the load.

A single ERR pin serves both regulators in the ADP3302 and indicates that one or both regulators are on the verge of losing regulation.

## APPLICATION CIRCUIT

### Dual Post Regulator Circuit for Switching Regulators

The ADP3302 can be used to implement a dual 3 V/100 mA post regulator power supply from a 1 cell Li-Ion input (Figure 20). This circuit takes 2.5 V to 4.2 V as the input and delivers dual 3 V/100 mA outputs. Figure 21 shows the typical efficiency curve.

For ease of explanation, let's partition the circuit into the ADP3000 step-up regulator section and the ADP3302 low dropout regulation section. Furthermore, let's divide the operation of this application circuit into the following three phases.

# ADP3302

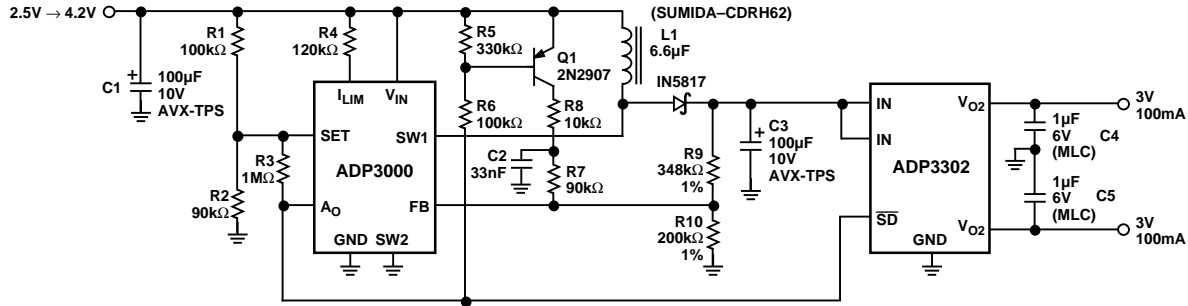

Figure 20. Cell Li-Ion to 3V/200mA Converter with Shutdown at  $V_{IN} < 2.5V$

**Phase One:** When the input voltage is equal to 3.7V or higher, the ADP3000 is off and the ADP3302 operates on its own to regulate the output voltage. At this phase, current is flowing into the input pins of the ADP3302 via the inductor L1 and the Schottky diode. At the same time, the ADP3000 is set into sleep mode by pulling the FB pin (via R9 and R10 resistor divider network) to about 10% higher than its internal reference which is set to be 1.245V.

**Phase Two:** As the input voltage drops below 3.7V, the decreasing input voltage causes the voltage of the FB pin to be within 5% of the 1.245V reference. This triggers the ADP3000 to turn on, providing a 3.4V regulated output to the inputs of the ADP3302. The ADP3000 continues to supply the 3.4V regulated voltage to the ADP3302 until the input voltage drops below 2.5V.

**Phase Three:** When the input voltage drops below 2.5V, the ADP3302 will shut down and the ADP3000 will go into sleep mode. With the input voltage below 2.5V, the resistor divider network, R1 and R2, applies a voltage that is lower than the ADP3000's internal 1.245V reference voltage to the SET pin. This causes the A<sub>O</sub> pin to have a voltage close to 0V, which causes the ADP3302 to go into shutdown directly and Q1 to turn on and pull the FB pin 10% or higher than the internal 1.245V reference voltage. With the FB pin pulled high, the ADP3000 goes into sleep mode.

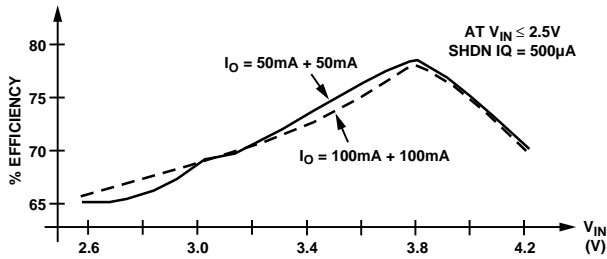

Figure 21. Typical Efficiency of the Circuit of Figure 20

Refer to Figure 20. R9 and R10 set the output voltage of the ADP3000. R1, R2, and R3 set the shutdown threshold voltage for the circuit. For further details on the ADP3000, please refer to the ADP3000 data sheet.

## Supply Sequencing Circuit

Figure 22 shows a simple and effective way to achieve sequencing of two different output voltages, 3.3V and 5V, in a mixed supply voltage system. In most cases, these systems need careful sequencing for the supplies to avoid latchup.

At turn-on, D1 rapidly charges up C1 and enables the 5V output. After a R2-C2 time constant delay, the 3.3V output is enabled. At turn-off, D2 quickly discharges C2 and R3 pulls SD1 low, turning off the 3.3V output first. After a R1-C1 time constant delay, the 5V output turns off.

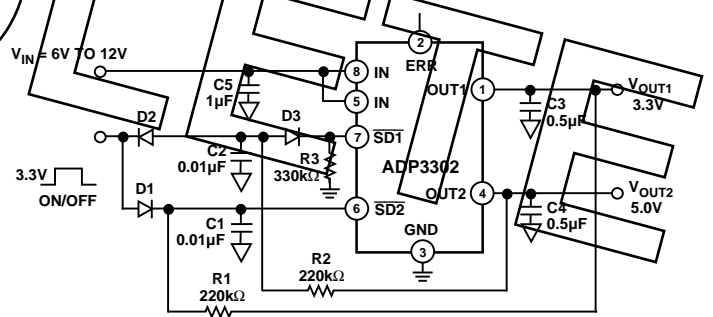

Figure 22. Turn-On/Turn-Off Sequencing for Mixed Supply Voltages

## OUTLINE DIMENSIONS

Dimensions shown in inches and (mm).

### 8-Pin SOIC (SO-8)

