



The Future of Analog IC Technology®

EV3378-S-00A

4 Strings, Step Up WLED Controller Plus High Efficiency Step down Converter

DESCRIPTION

The MP3378 is a one-chip solution, specially designed for monitor applications, which includes a step-up controller with 4 current channels for backlight and a high efficiency buck converter for internal bus voltage or standby power.

The 4-string WLED controller drives an external MOSFET to boost up the output voltage from the input supply. It regulates the current in each LED string to the programmed value set by an external current setting resistor. It can support both analog and PWM dimming independently to meet the special dimming mode request. In addition, rich protection modes are also integrated including OCP, OTP, UVP, OVP, LED short/open protection, inductor/diode short protection.

The high efficiency buck converter operates in the current mode operation with built in MOSFET and synchronous rectifier. It offers a very compact solution to achieve excellent load and line regulation. Full protection features include OCP and thermal shut down.

The MP3378 is available in SOIC28 package.

ELECTRICAL SPECIFICATIONS

Parameter	Symbol	Value	Units
Input Voltage	V_{IN}	8– 24	V
LEDs #		4 LED strings 10 LEDs/string	
LED Current	I_{LED}	120/string	mA
I_{OUT} Current (buck)	I_{OUT}	2	A

FEATURES

WLED Controller:

- 4-String, Max 350mA/String WLED Controller
- Up to 24V Input Voltage Range
- 2.5% Current Matching Accuracy
- Programmable Switching Frequency
- PWM and Analog Dimming Mode
- LED Open and Short LED Protection
- Programmable Over-Voltage Protection
- Recoverable thermal Shutdown Protection
- Over Current Protection
- Over Temperature Protection
- Inductor/Diode short Protection

Buck Converter:

- 90mΩ/40mΩ Low Rds(on) Internal Power MOSFETs
- Low Quiescent Current
- Fixed 235kHz Switching Frequency
- Frequency Sync from 250kHz to 2MHz External Clock
- AAM Power Save Mode
- Internal Soft Start
- OCP Protection and Hiccup
- Over Temperature Protection
- Output Adjustable from 0.8V

APPLICATIONS

- LCD Monitors

All MPS parts are lead-free, halogen free, and adhere to the RoHS directive. For MPS green status, please visit MPS website under Quality Assurance.

“MPS” and “The Future of Analog IC Technology” are Registered Trademarks of Monolithic Power Systems, Inc.

EV3378-S-00A EVALUATION BOARD

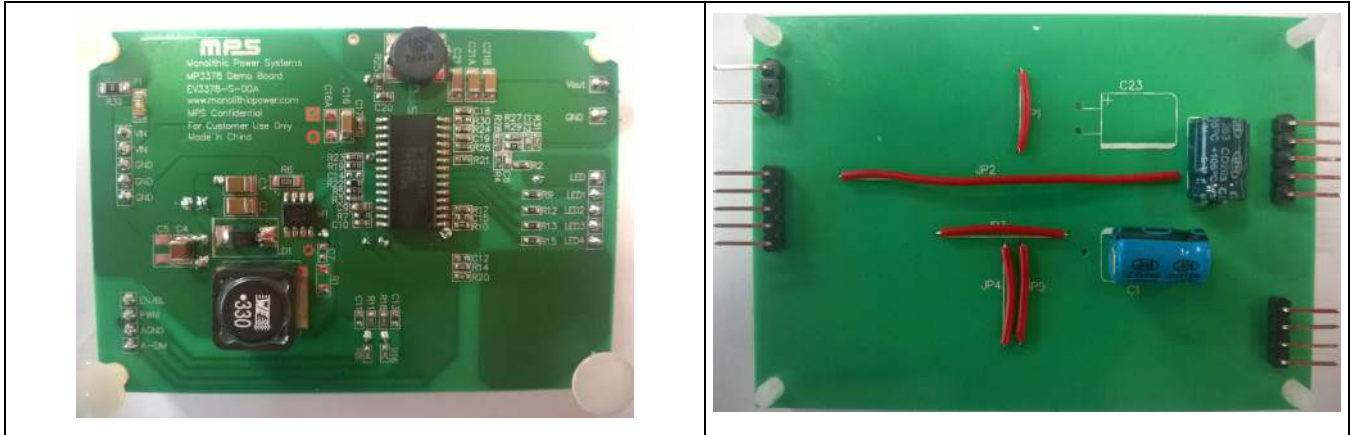

(L x W x H) 5.9cm x 8.4cm x 2cm

Board Number	MPS IC Number
EV3378-S-00A	MP3378GY

EVALUATION BOARD SCHEMATIC

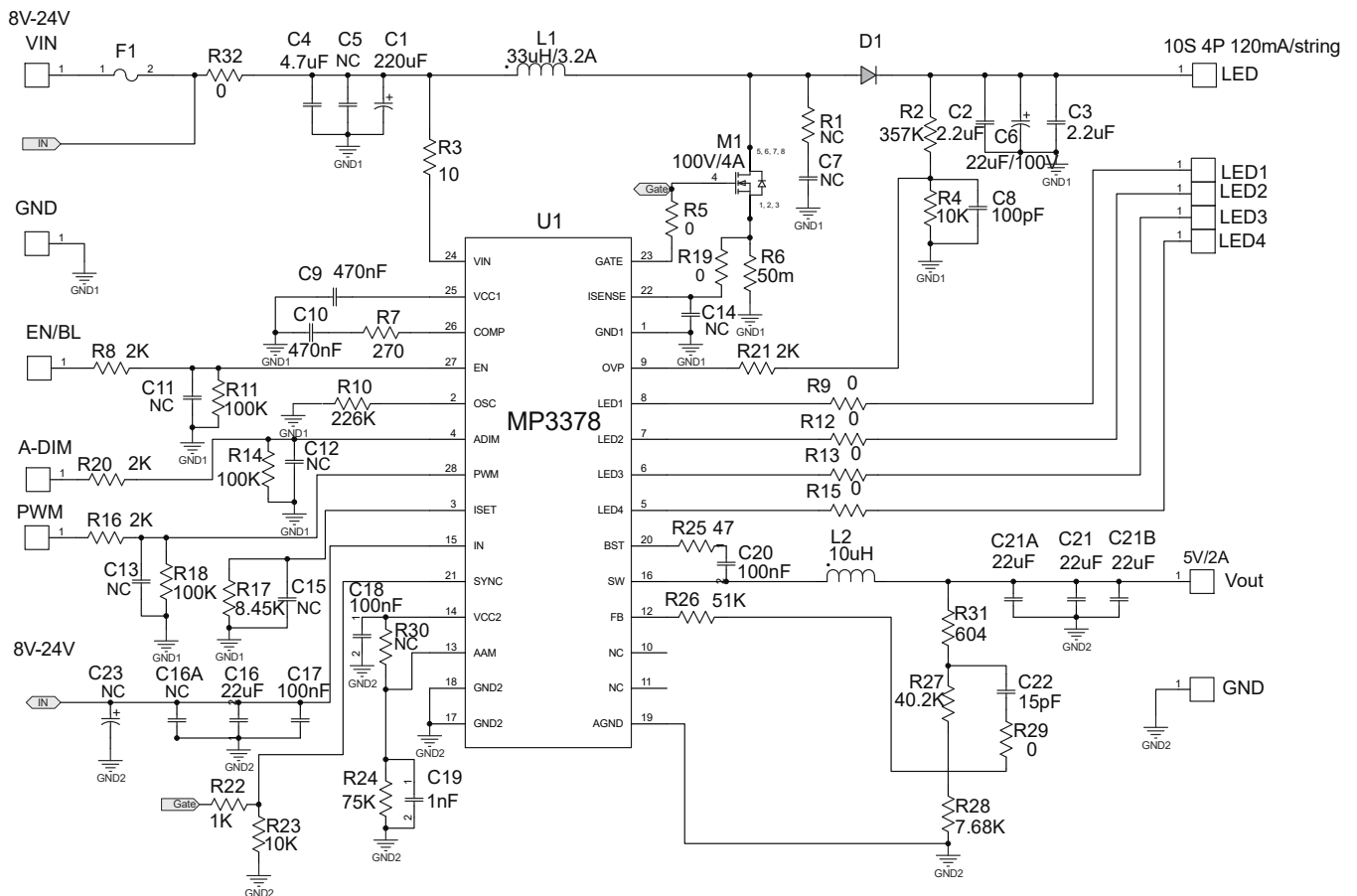

EV3378-S-00A BILL OF MATERIALS

Qty	Ref	Value	Description	Package	Manufacturer	Part Number
1	C1	220 μ F	Electrolytic Capacitor; 35V;Electrolytic;DIP;	DIP	江海	CD110-35V220
2	C2, C3	2.2 μ F	Ceramic Capacitor; 100V;X7R;1210;	1210	muRata	GRM32ER72A225KA35L
1	C4	4.7 μ F	Ceramic Capacitor; 50V;X7R;	1210	TDK	C3225X7R1H475K
1	C6	22 μ F /100V	22u;100V;	DIP	江海	CD263-100V22'
1	C8	100pF	Ceramic Capacitor; 50V;C0G;0603;	0603	muRata	GRM1885C1H101JA01D
1	C9	470nF	Ceramic Capacitor; 16V;X7R;	0805	muRata	GRM21BR61C474KA01L
1	C10	470nF	Ceramic Capacitor; 16V;X7R;0603;	0603	TDK	C1608X7R1C474K
1	C16	22 μ F	Ceramic Capacitor; 25V;X5R;	1206	muRata	GRM31CR61E226KE15
3	C17, C18, C20	100nF	Ceramic Capacitor; 25V;X7R;0603;	0603	muRata	GRM188R71E104KA01D
1	C19	1nF	Ceramic Capacitor; 50V;C0G;0603;	0603	muRata	GRM1885C1H102JA01D
3	C21, C21A, C21B	22 μ F	Ceramic Capacitor; 6.3V;X5R;1206	1206	TDK	C3216X5R0J226M
1	C22	15pF	Ceramic Capacitor; 50V;C0G;0603;	0603	TDK	C1608C0G1H150J
1	C5	NC		1210		
6	C7, C11, C12, C13, C14, C15	NC		0603		
1	C16A	NC		1206		
1	C23	NC		DIP		
1	D1	B160	Schottky Diode;60V;1A;	SMA	Diodes	B160
1	F1	0429005. WRM	Fuse;24V;5A;	1206	littlefuse	0429005.WRM
1	L1	33 μ H /3.5A	Inductor;33uH;33m;3.5A;	SMD	Würth	744314101
1	L2	10 μ H	Inductor;10uH;36m;3.2A;	SMD	TMP	SPC-08045-100GP
1	M1	AM4490N	N-Channel Mosfet; 100V;92;12.5;5.2;	SO-8	Analog Power	AM4490N
1	R2	357k	Film Resistor;1%;	0603	Yageo	RC0603FR-07357KL
1	R3	10	Film Resistor;1%;	0603	Yageo	RC0603FR-0710RL
2	R4, R23	10k	Resistor;1%;	0603	Yageo	RC0603FR-0710KL

EV3378-S-00A BILL OF MATERIALS (continued)

Qty	Ref	Value	Description	Package	Manufacturer	Part Number
7	R5, R9, R12, R13, R15, R19, R29	0	Film Res; 1%;	0603	Yageo	RC0603FR-070RL
1	R6	50m	Film Resistor;1%;	1206	Yageo	RL1206FR-070R05L
1	R7	270	Film Resistor;1%;	0603	Yageo	RC0603FR-07270RL
4	R8, R16, R20, R21	2k	Film Resistor;1%;	0603	Yageo	RC0603FR-072KL
1	R10	226k	Film Resistor;1%;	0603	Yageo	RC0603FR-07226KL
3	R11, R14, R18	100k	Film Resistor;1%;	0603	Yageo	RC0603FR-07100KL
1	R17	8.45k	Film Resistor;1%;	0603	Yageo	RC0603FR-078K45L
1	R22	1k	Film Resistor;1%;	0603	Yageo	RC0603FR-071KL
1	R24	75k	Film Resistor;1%;	0603	Yageo	RC0603FR-0775KL
1	R25	47	Film Resistor;1%;	0603	Yageo	RC0603FR-0747RL
1	R26	51k	Film Resistor;1%;	0603	SYN- TON- TECH	RC0603FR-0751KL
1	R27	40.2k	Film Resistor;1%;	0603	Yageo	RC0603FR-0740K2L
1	R28	7.68k	Film Resistor;1%	0603	Yageo	RC0603FR-077K68L
1	R31	604	Film Resistor;1%	0603	Yageo	RC0603FR-07604RL
1	R32	0	Resistor;1%;1/4W;	1206	Yageo	RC1206FR-070RL
1	R1,R30	NC	Film Res; 1%	0603		
1	U1		MP3378	SOIC28	MPS	

EVB TEST RESULTS

Performance waveforms are tested on the evaluation board.

VIN = 16V, 10 LEDs in series, 4 strings parallel, 120mA/string, TA = 25°C, unless otherwise noted.

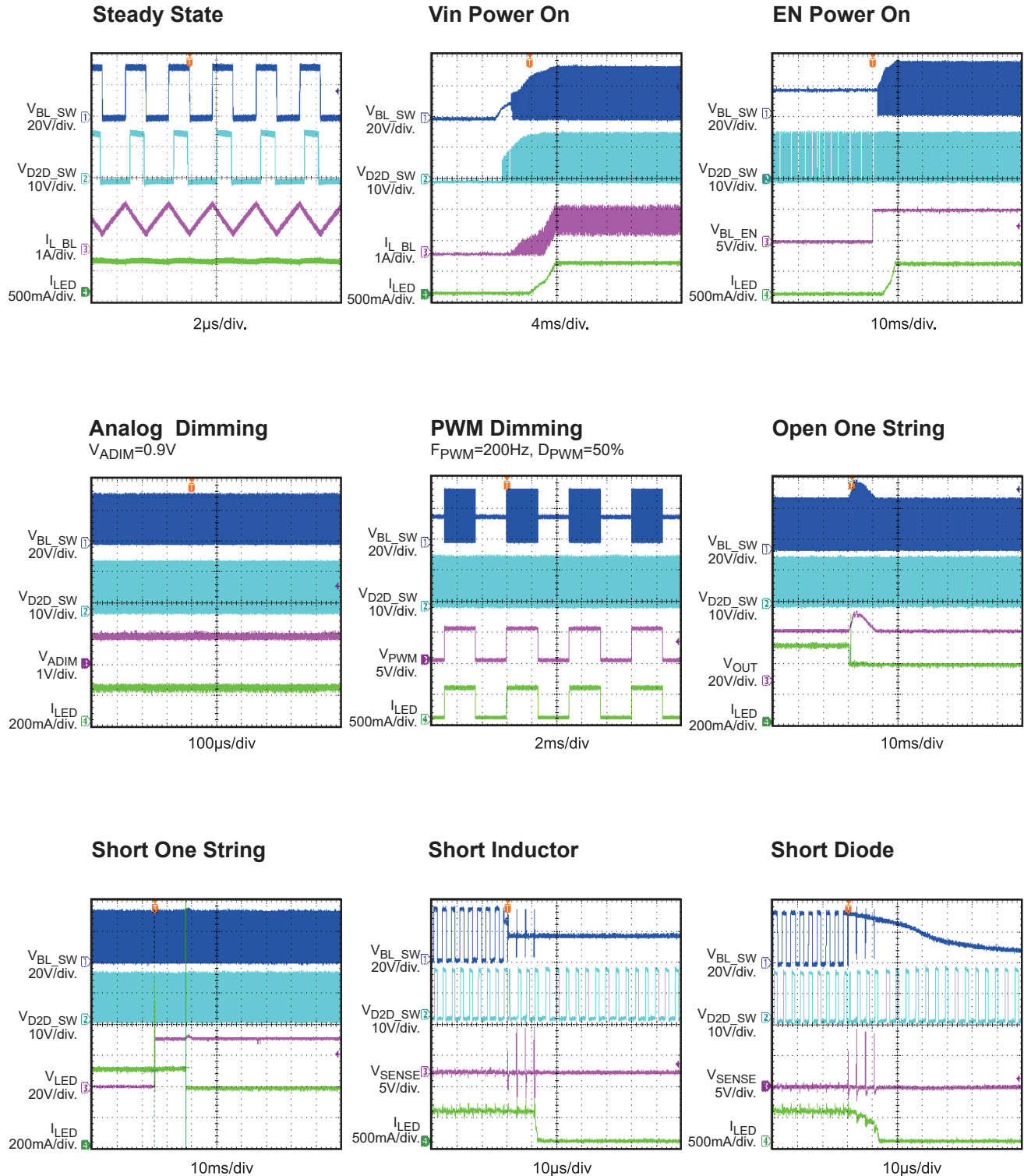

EVB TEST RESULTS *(continued)*

Performance waveforms are tested on the evaluation board.

$V_{IN} = 16V$, 10 LEDs in series, 4 strings parallel, 120mA/string, $T_A = 25^\circ C$, unless otherwise noted.

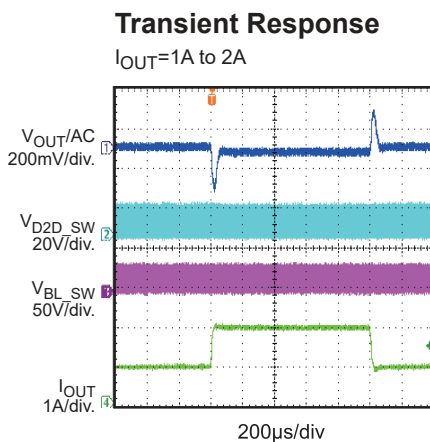
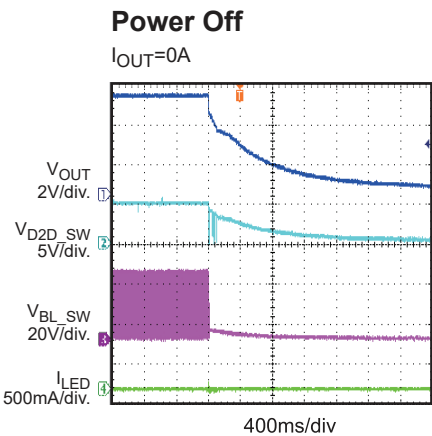
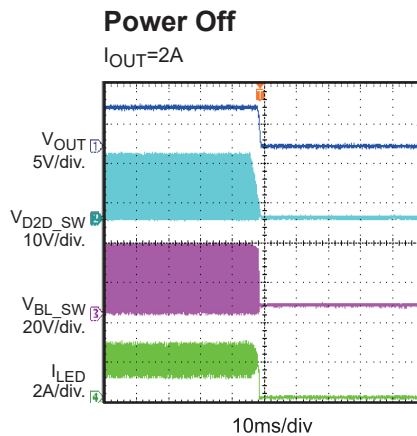
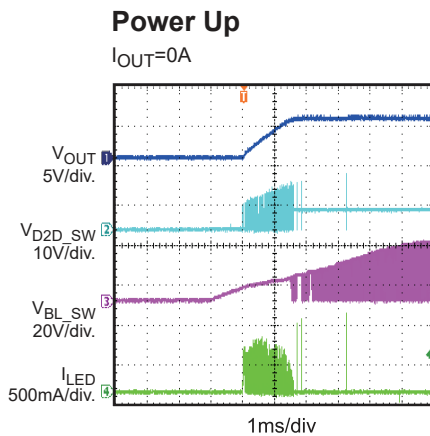
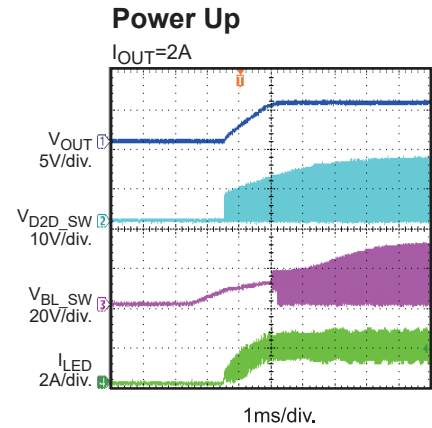
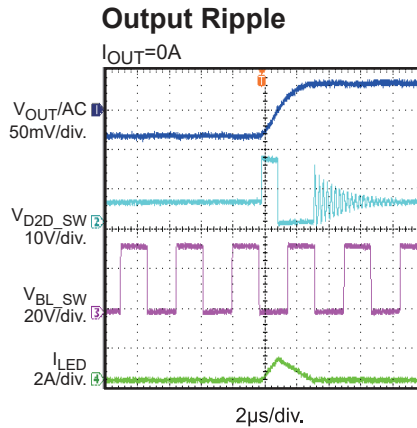
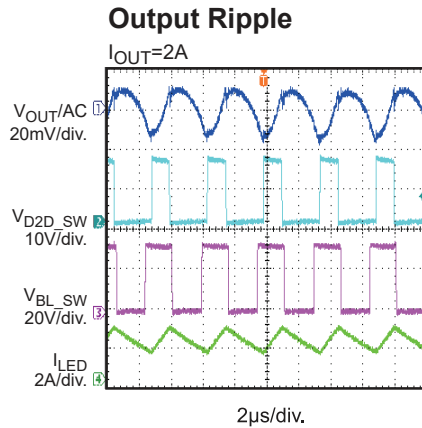

PRINTED CIRCUIT BOARD LAYOUT

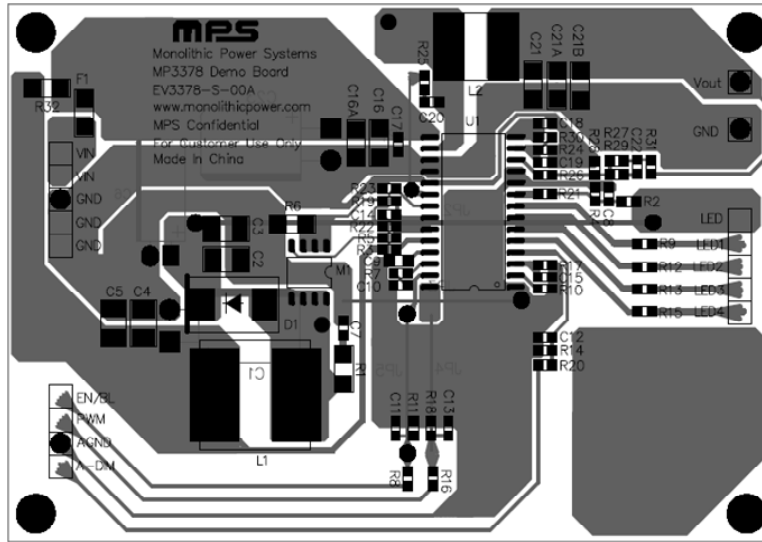

Figure 1—Top Layer

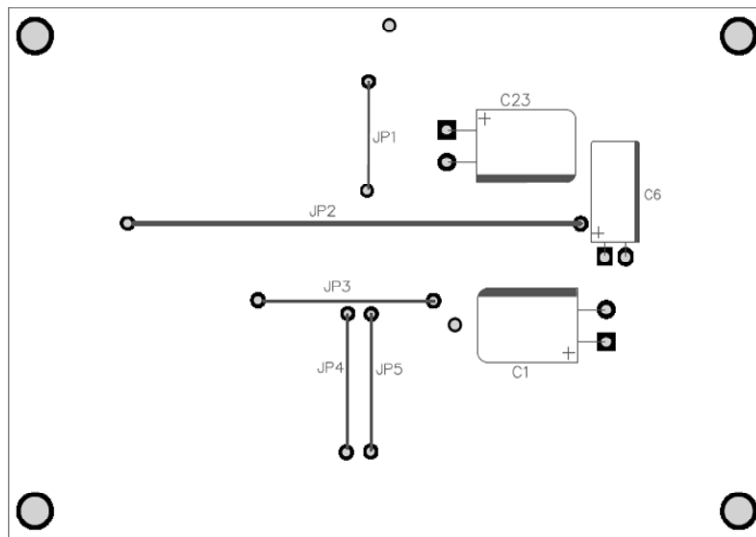

Figure 2—Bottom Layer

QUICK START GUIDE

1. For Boost LED Controller, connect the positive and negative terminals of the load panel (10 white LEDs in series, 4 strings) to the LED and LED1~4 pins on the EV board, respectively.

For Buck Converter, connect the load between Vout to GND.

2. Connect the positive and negative terminals of the power supply (8V ~ 24V) to the VIN and GND pins on the EV board, respectively. Then the Buck Converter will work.
3. Pull both PWM and A-DIM pin to high level (1.5-5V).
4. Pull EN/BL pin high (1.5-5V) to enable the Boost LED Controller.
5. For PWM dimming, apply a PWM rectangular waveform with a minimum voltage less than 0.4V and a maximum greater than 1.5V on PWM pin. The LED current is chopped by PWM signal. The frequency of the PWM signal is recommended between 200Hz to 2kHz.
6. For analog dimming, apply a DC waveform with a voltage between 0.4 and 1.5V on A-DIM pin; or a PWM rectangular waveform with a minimum voltage less than 0.4V and a maximum greater than 1.5V on A-DIM pin, the frequency of the PWM signal is recommended ≥ 20 kHz. The amplitude of LED current linearly follows the voltage of A-DIM or the duty of the PWM signal.

REVISION HISTORY

Revision #	Revision Date	Description	Pages Updated
1.0	2/2/2015	Initial Release	-
1.1	5/22/2023	Updated the fixed switching frequency from 233kHz to 235kHz	1
		Changed the MPS IC Number from MP3378GS to MP3378GY	2

NOTICE: The information in this document is subject to change without notice. Users should warrant and guarantee that third party Intellectual Property rights are not infringed upon when integrating MPS products into any application. MPS will not assume any legal responsibility for any said applications.