

APPROVED: \_\_\_\_\_  
 DATE: \_\_\_\_\_ TITLE: \_\_\_\_\_

Rev	AWO #	Description	Date	Appr
-		RELEASED	5/27/16	
A		UPDATE DRAWING	8/16/22	LH/NL

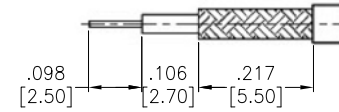

RECOMMENDED CABLE STRIPPING DIMS

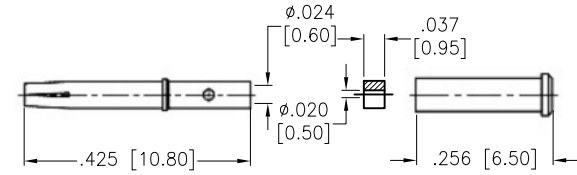
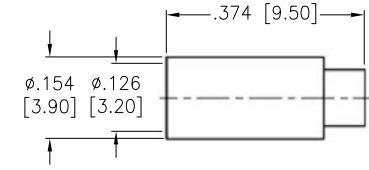
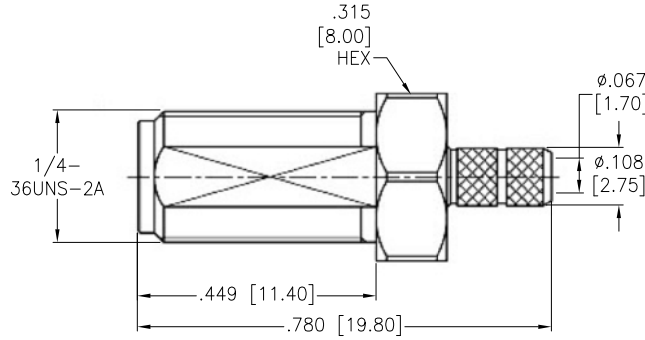
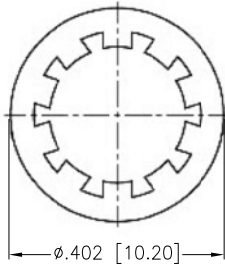
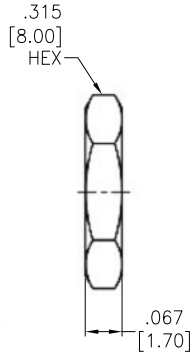
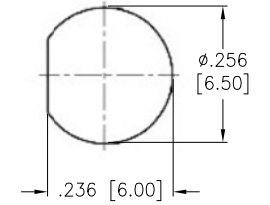

RECOMMENDED MOUNTING HOLE

SPACER	PTFE	WHITE
HEX NUT	BRASS	GOLD
WASHER	S50C	GOLD
FERRULE	BRASS	GOLD
SLEEVE	BRASS	GOLD
CONTACT PIN	BRASS	GOLD
INSULATOR	PTFE	WHITE
BURREL	BRASS	GOLD
DESCRIPTION	MATERIAL	FINISH

**SPECIFICATIONS:**

Electrical:  
 Frequency range: DC-6 GHz  
 Nominal Impedance: 50 Ohms  
 Working Voltage: 170 VOLTS max  
 Proof Voltage: 500 VOLTS  
 VSWR : 1.3 Max @ 3 GHz  
 Temperature Rating:  
 Operating temperature: -65°C to +165°C  
 Environmental:  
 Lead free, RoHS compliant.



UNLESS OTHERWISE SPECIFIED ALL DIMENSIONS ARE INCHES [MM]. TOLERANCES: EXCEPT AS NOTED

INCHES		HOLES	
.X	±.10	Ø.X	±.10
.XX	±.020	Ø.XX	±.015
.XXX	±.015	Ø.XXX	±.010

DRAWN AY 5/27/16

CHECKED SY 5/27/16

APPROVED

THIS DRAWING CONTAINS INFORMATION THAT IS PROPRIETARY AND SHOULD NOT BE USED WITHOUT PRIOR WRITTEN PERMISSION FROM ADAM TECH



909 Rahway Avenue,  
 Union, NJ 07083  
 Phone: 908-687-5000  
 Fax: 908-687-5710

TITLE  
 SMA JACK STR BULKHEAD, 50OHM, 178U

SIZE	PART NO.	REV.
X	RF2-06A-T-21-50-G	A
REF: S00277T	SCALE: NTS	SHEET 1 OF 1