

# DT04-08PA-P026 ✓ ACTIVE

DEUTSCH | DEUTSCH DT

TE Internal #: DT04-08PA-P026

Housing for Male Terminals, Bus Bar-to-Wire, 8 Position, .359 in [9.12 mm] Centerline, Sealable, Gray, Wire & Cable / Bus Bar, DEUTSCH DT

[View on TE.com >](#)



Connectors > Automotive Connectors > Automotive Housings > DEUTSCH DT Receptacle Connectors

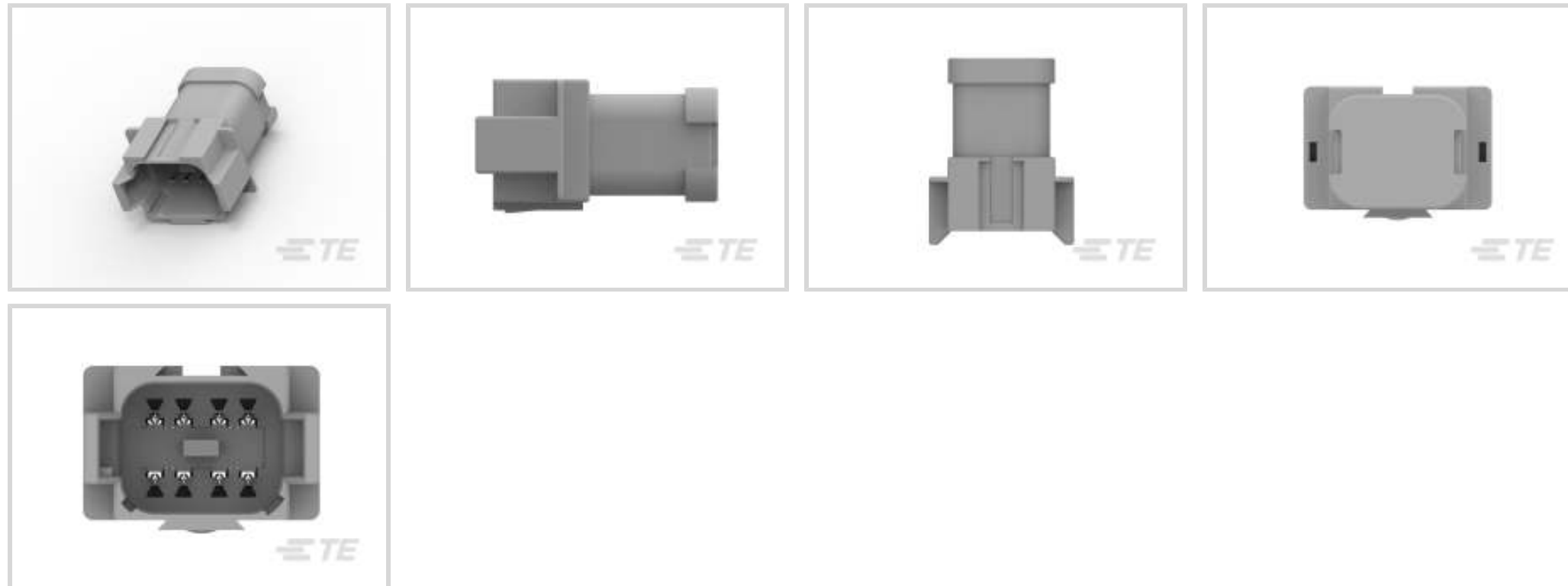

Connector & Housing Type: **Housing for Male Terminals**

Mating Pin Diameter: **1.59 mm [ .063 in ]**

Connector System: **Bus Bar-to-Wire**

Number of Positions: **8**

Centerline (Pitch): **9.12 mm [ .359 in ]**

[All DEUTSCH DT Receptacle Connectors \(241\)](#)

## Features

### Product Type Features

Connector Shape	Rectangular
Connector & Housing Type	Housing for Male Terminals
Connector System	Bus Bar-to-Wire
Sealable	Yes
Hybrid Connector	No
Primary Locking Feature	Integrated in Housing
Connector & Contact Terminates To	Bus Bar, Wire & Cable

### Configuration Features

Blank Cavity Position	0
Connector Modification	(2) 4 Pin Busses
Number of Positions	8
Number of Rows	2



### Electrical Characteristics

Operating Voltage	250 VAC
Nominal Voltage Architecture	12 V, 24 V, 48 V

### Body Features

Cable Exit Angle	180°
Primary Product Color	Gray
Connector & Keying Code	A

### Contact Features

Contact Type	Pin
Mating Pin Diameter	1.59 mm[.063 in]
Contact Current Rating (Max)	13 A

### Mechanical Attachment

Terminal Position Assurance	Yes
Strain Relief	Add By Accessory
Mating Alignment Type	Keyed
Mating Alignment	With
Connector Mounting Type	Bus Bar Mount

### Housing Features

Housing Material	PA GF
Centerline (Pitch)	9.12 mm[.359 in]

### Dimensions

Connector Height	23.88 mm[.94 in]
Product Width	36.45 mm[1.435 in]
Product Length	46.94 mm[1.848 in]
Row-to-Row Spacing	4.45 mm[.175 in]

### Usage Conditions

Operating Temperature (Max)	125 °C[257 °F]
Operating Temperature Range	-55 – 125 °C[-67 – 257 °F]

### Operation/Application

Circuit Application	Power & Signal
---------------------	----------------

### Industry Standards

Degree of Protection	IP68, IP6K9K
----------------------	--------------



Agency/Standard	SAE J2030
UL Flammability Rating	Not tested

### Packaging Features

Packaging Quantity	300
Packaging Method	Box

### Other

Serviceable	Yes
Connector Position Assurance Capable	No

### Product Compliance

[For compliance documentation, visit the product page on TE.com>](#)

EU RoHS Directive 2011/65/EU	Compliant
EU ELV Directive 2000/53/EC	Compliant
China RoHS 2 Directive MIIT Order No 32, 2016	No Restricted Materials Above Threshold
EU REACH Regulation (EC) No. 1907/2006	Current ECHA Candidate List: JUNE 2023 (235) Candidate List Declared Against: JAN 2023 (233) Does not contain REACH SVHC
Halogen Content	Not Low Halogen - contains Br or Cl > 900 ppm.
Solder Process Capability	Not reviewed for solder process capability

#### Product Compliance Disclaimer

This information is provided based on reasonable inquiry of our suppliers and represents our current actual knowledge based on the information they provided. This information is subject to change. The part numbers that TE has identified as EU RoHS compliant have a maximum concentration of 0.1% by weight in homogenous materials for lead, hexavalent chromium, mercury, PBB, PBDE, DBP, BBP, DEHP, DIBP, and 0.01% for cadmium, or qualify for an exemption to these limits as defined in the Annexes of Directive 2011/65/EU (RoHS2). Finished electrical and electronic equipment products will be CE marked as required by Directive 2011/65/EU. Components may not be CE marked. Additionally, the part numbers that TE has identified as EU ELV compliant have a maximum concentration of 0.1% by weight in homogenous materials for lead, hexavalent chromium, and mercury, and 0.01% for cadmium, or qualify for an exemption to these limits as defined in the Annexes of Directive 2000/53/EC (ELV). Regarding the REACH Regulation, the information TE provides on SVHC in articles for this part number is based on the latest European Chemicals Agency (ECHA) 'Guidance on requirements for substances in articles' posted at this URL: <https://echa.europa.eu/guidance-documents/guidance-on-reach>

### Compatible Parts

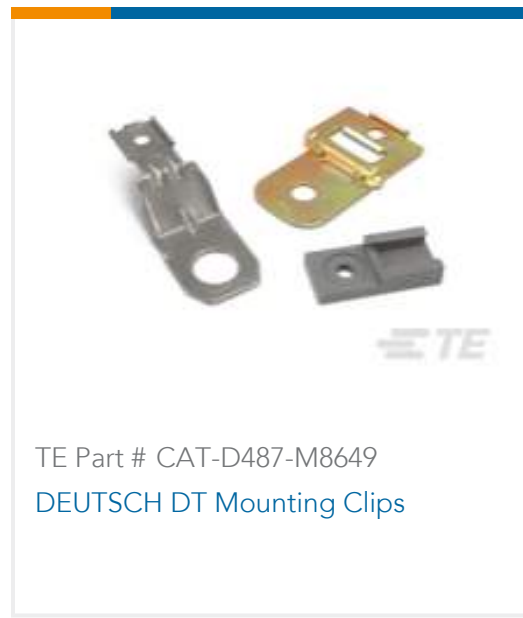

## Also in the Series | DEUTSCH DT

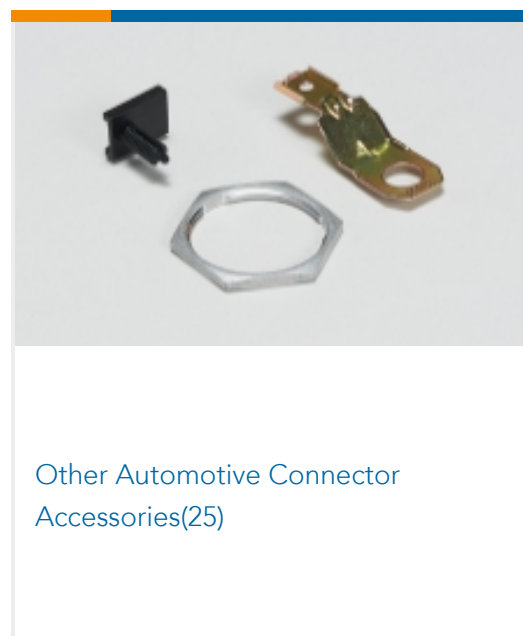
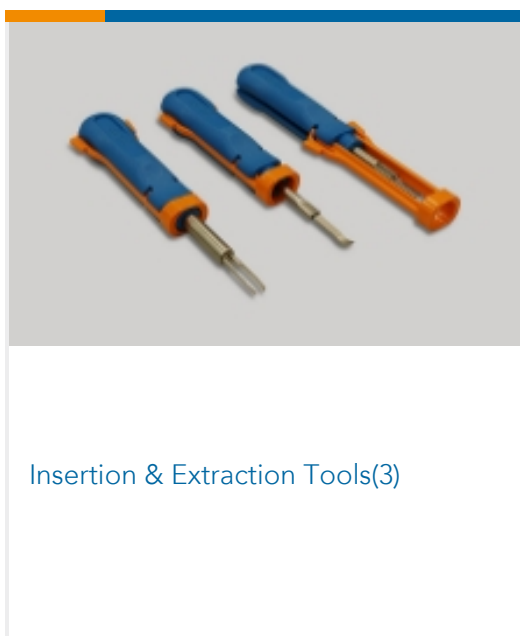
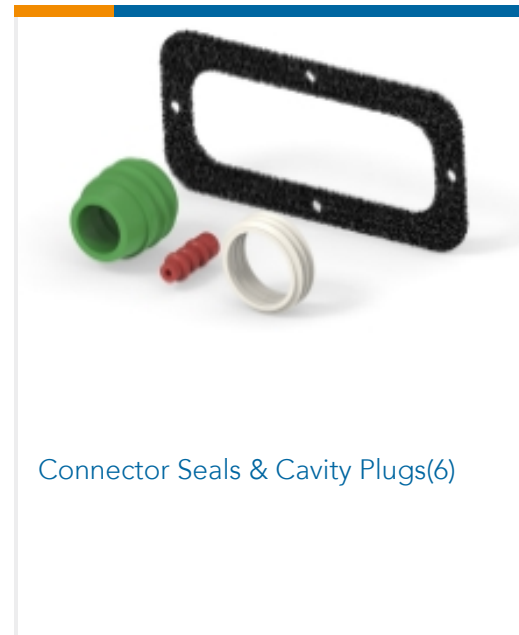
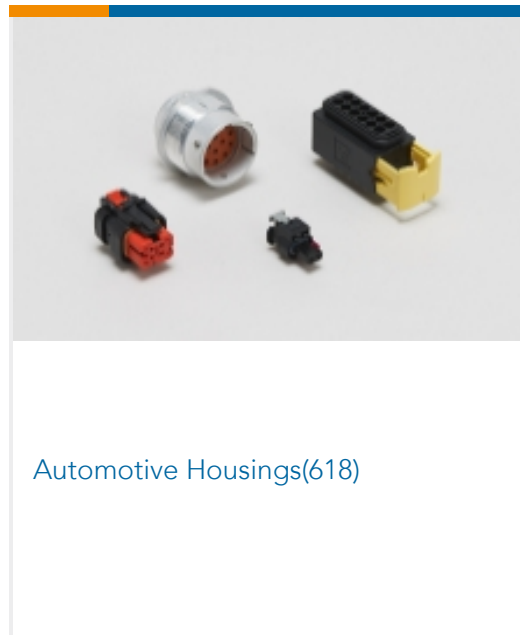
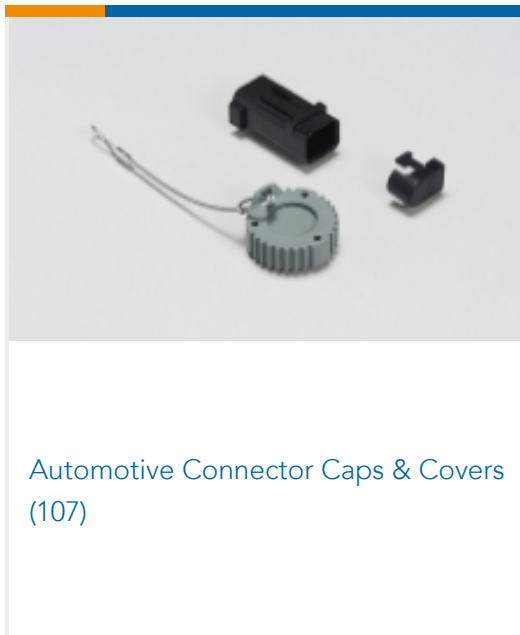

## Customers Also Bought



## Documents

### Product Drawings

REC, 8P, GRY, BUSBAR 2X4, NICKEL, A

English

### CAD Files

3D PDF

3D



### Customer View Model

[ENG\\_CVM\\_CVM\\_DT04-08PA-P026\\_A.2d\\_dxf.zip](#)

English

### Customer View Model

[ENG\\_CVM\\_CVM\\_DT04-08PA-P026\\_A.3d\\_igs.zip](#)

English

### Customer View Model

[ENG\\_CVM\\_CVM\\_DT04-08PA-P026\\_A.3d\\_stp.zip](#)

English

By downloading the CAD file I accept and agree to the [Terms and Conditions](#) of use.

## Datasheets & Catalog Pages

[ICT Terminals and Connectors Catalogue](#)

English

[CONNECTOR SELECTOR](#)

English

## Product Specifications

[Application Specification](#)

English