

GaAs MMIC SMT SINGLE BALANCED MIXER, 0.7 - 1.2 GHz



Typical Applications

The HMC277MS8 / HMC277MS8E is ideal for:

- Cellular / 3G Infrastructure
- Basestations & Repeaters
- GSM, CDMA & WCDMA
- Subscribers & Portables

Features

- Passive Topology
- LO / RF Isolation: 26 dB
- Input IP3: +21 dBm
- Low Conversion Loss: 9 dB
- RoHS Compliant MSOP-8 Package

Functional Diagram

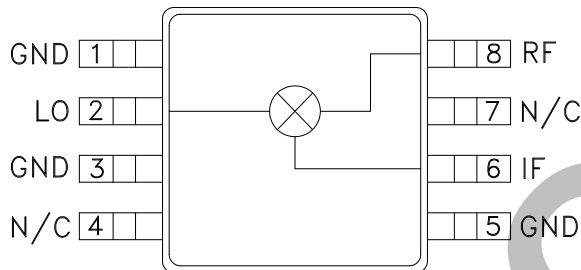

General Description

The HMC277MS8 & HMC277MS8E are general purpose single balanced mixers in 8 lead plastic surface mount Mini Small Outline Packages (MSOP). This passive MMIC mixer is constructed of GaAs Schottky diodes and a novel planar transformer balun on the chip. The HMC277MS8(E) requires no external matching components, and is ideal for upconverter and downconverter applications. The RF port is balanced via the MMIC balun while the LO port is connected directly to the diodes. This product is pin for pin compatible with the HMC272MS8(E) which operates from 1.7 to 3.0 GHz.

Electrical Specifications, $T_A = +25^\circ\text{C}$, LO = +13 dBm, IF = 100 MHz*

Parameter	Min.	Typ.	Max.	Units
Frequency Range, RF & LO	0.7 - 1.2			GHz
Frequency Range, IF	DC - 0.3			GHz
Conversion Loss		9	10.5	dB
Noise Figure (SSB)		9	10.5	dB
LO to RF Isolation	20	26		dB
LO to IF Isolation	8	12		dB
IP3 (Input)	17	21		dBm
1 dB Compression (Input)	9	12		dBm

*Unless otherwise noted, all measurements performed as a downconverter with low side LO.



GaAs MMIC SMT SINGLE BALANCED MIXER, 0.7 - 1.2 GHz

Conversion Gain vs. Temperature @ LO = +13 dBm

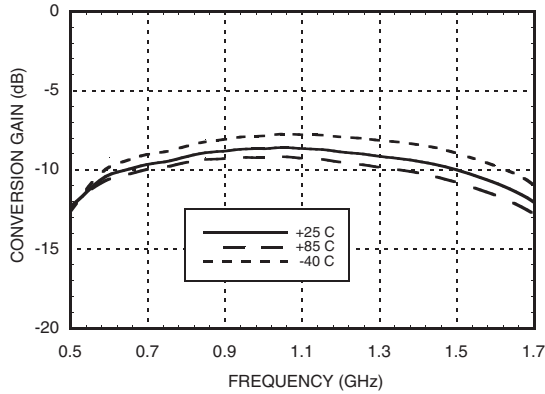

Isolation @ LO = +13 dBm

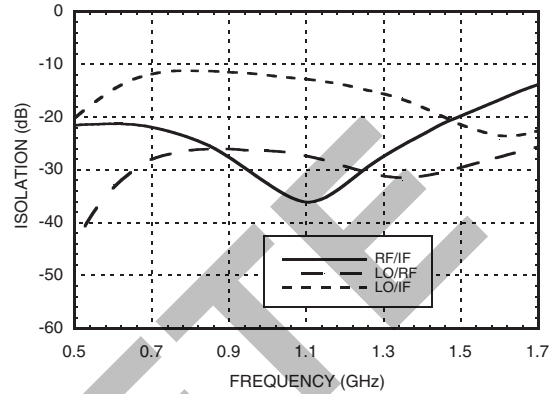

Conversion Gain vs. LO Drive

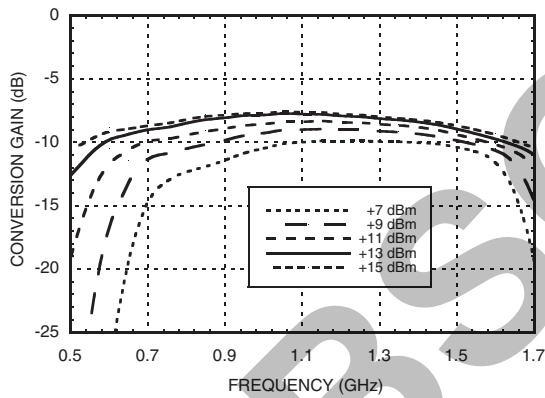

Return Loss @ LO = +13 dBm

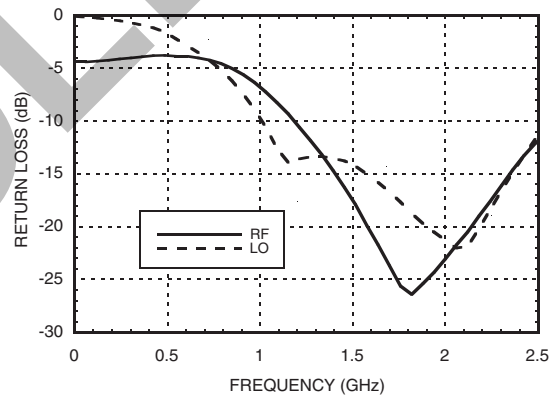

IF Bandwidth & IF Return Loss @ LO = +13 dBm

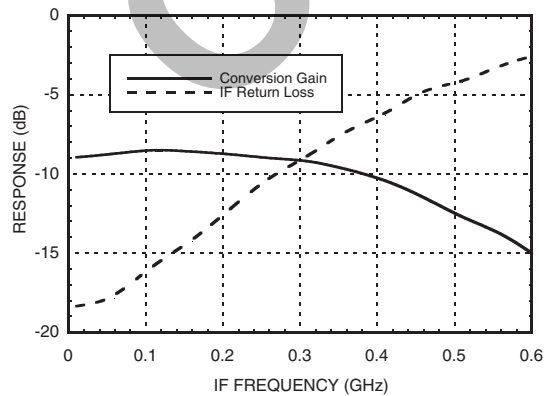

P1dB vs. Temperature @ LO = +13 dBm

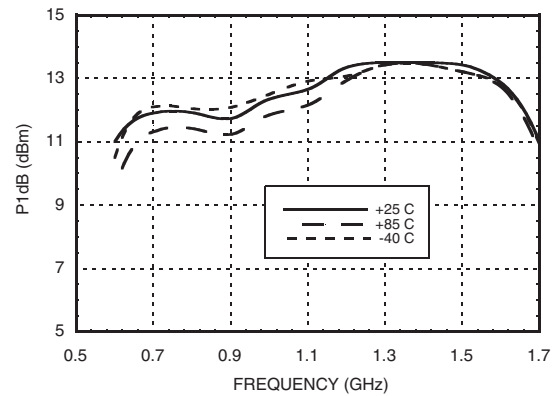

Information furnished by Analog Devices is believed to be accurate and reliable. However, no responsibility is assumed by Analog Devices for its use, nor for any infringements of patents or other rights of third parties that may result from its use. Specifications subject to change without notice. No license is granted by implication or otherwise under any patent or patent rights of Analog Devices. Trademarks and registered trademarks are the property of their respective owners.

For price, delivery, and to place orders: Analog Devices, Inc., One Technology Way, P.O. Box 9106, Norwood, MA 02062-9106 Phone: 781-329-4700 • Order online at www.analog.com Application Support: Phone: 1-800-ANALOG-D



HMC277MS8 / 277MS8E

GaAs MMIC SMT SINGLE BALANCED MIXER, 0.7 - 1.2 GHz

Input IP3 vs. LO Drive

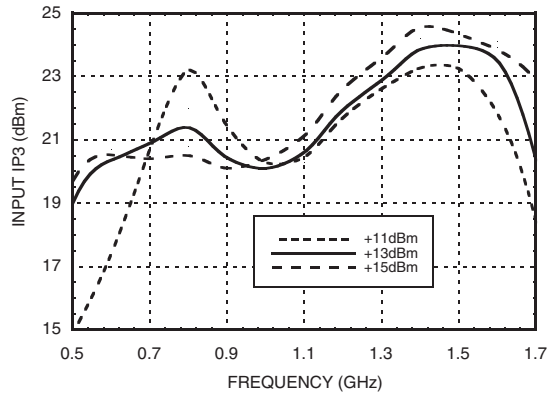

Input IP3 vs. Temperature @ LO = +13 dBm

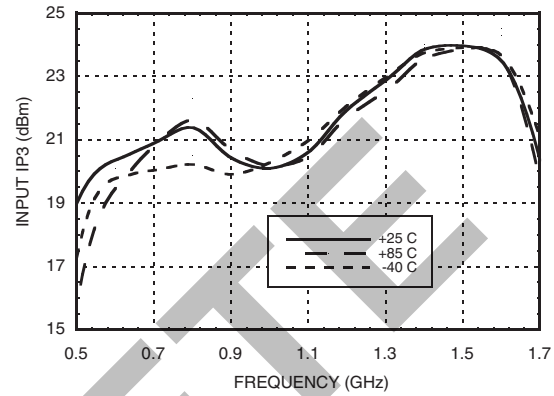

Input IP2 vs. LO Drive

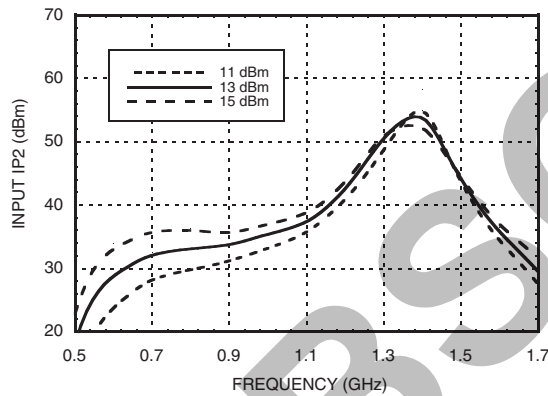

Input IP2 vs. Temperature @ LO = +13 dBm

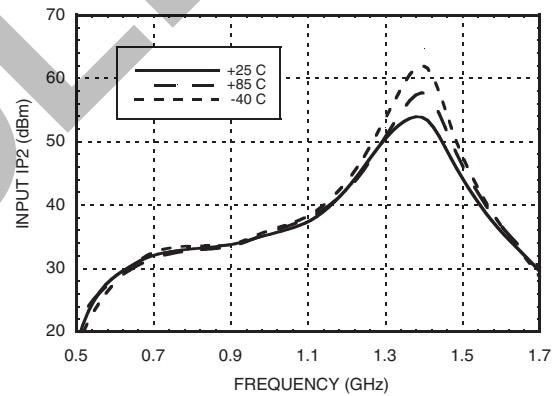

MxN Spurious Outputs

mRF	nLO				
	0	1	2	3	4
0	xx	-15	4	25	19
1	19	0	36	38	36
2	44	49	52	40	63
3	69	83	87	62	74
4	95	90	90	93	78

RF = 0.96 GHz @ -5 dBm
 LO = 0.8 GHz @ +13 dBm
 All values in dBc relative to the IF

Harmonics of LO

LO Frequency (GHz)	nLO Spur at RF Port			
	1	2	3	4
0.5	31	19	56	35
0.7	26	14	46	40
0.9	26	14	49	40
1.1	29	20	48	39
1.3	31	25	49	39
1.5	27	29	58	42

LO = +13 dBm
 Values in dBc below input LO level measured at the RF port.

GaAs MMIC SMT SINGLE BALANCED MIXER, 0.7 - 1.2 GHz



Absolute Maximum Ratings

RF / IF Input	+13 dBm
LO Drive	+27 dBm
Storage Temperature	-65 to +150 °C
Operating Temperature	-40 to +85 °C
ESD Sensitivity (HBM)	Class 1A



**ELECTROSTATIC SENSITIVE DEVICE
OBSERVE HANDLING PRECAUTIONS**

Outline Drawing

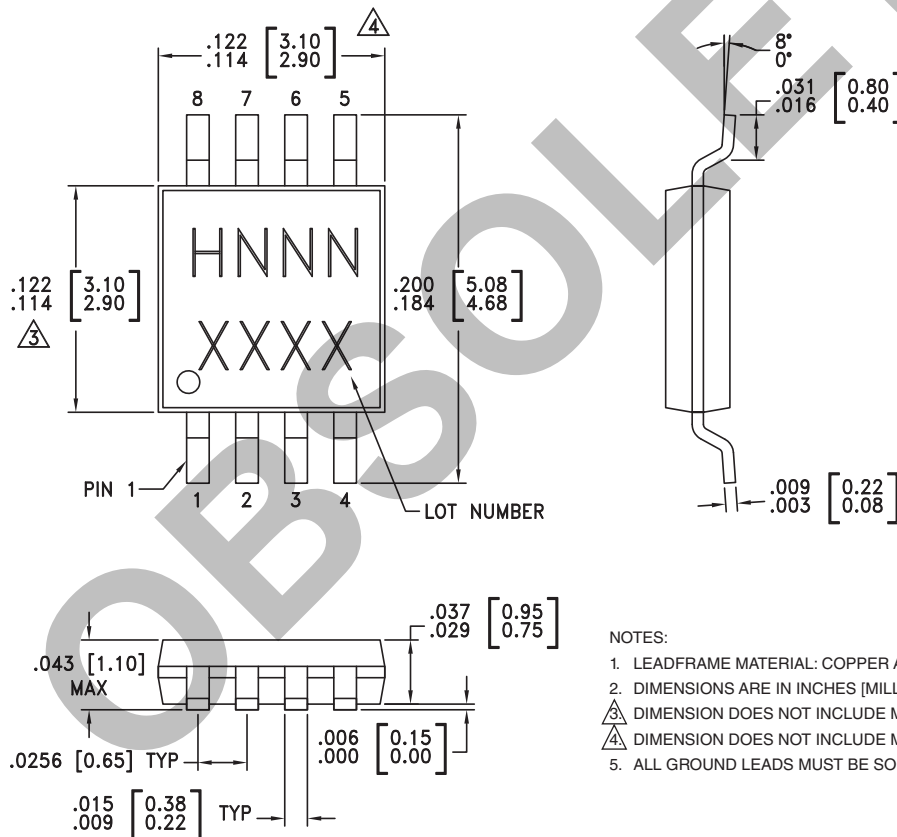

- NOTES:
- LEADFRAME MATERIAL: COPPER ALLOY
 - DIMENSIONS ARE IN INCHES [MILLIMETERS].
 - DIMENSION DOES NOT INCLUDE MOLDFLASH OF 0.15mm PER SIDE.
 - DIMENSION DOES NOT INCLUDE MOLDFLASH OF 0.25mm PER SIDE.
 - ALL GROUND LEADS MUST BE SOLDERED TO PCB RF GROUND.

Package Information

Part Number	Package Body Material	Lead Finish	MSL Rating	Package Marking ^[3]
HMC277MS8	Low Stress Injection Molded Plastic	Sn/Pb Solder	MSL1 ^[1]	H277 XXXX
HMC277MS8E	RoHS-compliant Low Stress Injection Molded Plastic	100% matte Sn	MSL1 ^[2]	<u>H277</u> XXXX

[1] Max peak reflow temperature of 235 °C
 [2] Max peak reflow temperature of 260 °C
 [3] 4-Digit lot number XXXX

Information furnished by Analog Devices is believed to be accurate and reliable. However, no responsibility is assumed by Analog Devices for its use, nor for any infringements of patents or other rights of third parties that may result from its use. Specifications subject to change without notice. No license is granted by implication or otherwise under any patent or patent rights of Analog Devices. Trademarks and registered trademarks are the property of their respective owners.

For price, delivery, and to place orders: Analog Devices, Inc., One Technology Way, P.O. Box 9106, Norwood, MA 02062-9106 Phone: 781-329-4700 • Order online at www.analog.com Application Support: Phone: 1-800-ANALOG-D

**GaAs MMIC SMT SINGLE
BALANCED MIXER, 0.7 - 1.2 GHz**
Pin Descriptions

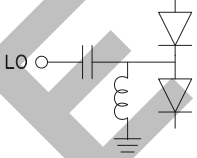
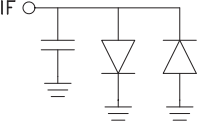
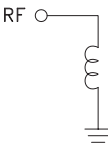
Pin Number	Function	Description	Interface Schematic
1, 3, 5	GND	This pin must be connected to RF ground.	
2	LO	This pin is AC coupled and matched to 50 Ohms.	
4, 7	N/C	No connection required. These pins may be connected to RF/DC ground without affecting performance.	
6	IF	This pin is DC coupled. For applications not requiring operation to DC this port should be DC blocked externally using a series capacitor. Choose value of capacitor to pass IF frequency desired. For operation to DC, this pin must not sink/source more than 40 mA of current or failure may result.	
8	RF	This pin is DC coupled and matched to 50 Ohms.	



Evaluation Circuit Board

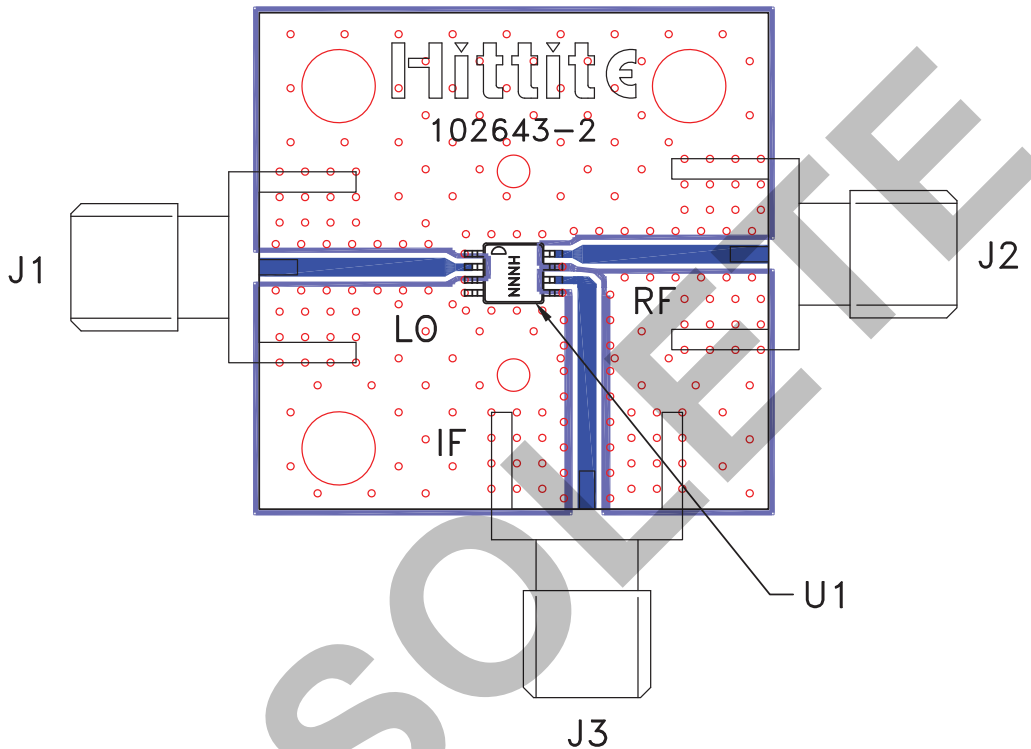

List of Materials for Evaluation PCB 115791 [1]

Item	Description
J1 - J3	PCB Mount SMA RF Connector
U1	HMC277MS8 / HMC272MS8E Mixer
PCB [2]	102643 Evaluation Board

[1] Reference this number when ordering complete evaluation PCB

[2] Circuit Board Material: Rogers 4350

The circuit board used in the final application should use RF circuit design techniques. Signal lines should have 50 ohm impedance while the package ground leads and exposed paddle should be connected directly to the ground plane similar to that shown. A sufficient number of via holes should be used to connect the top and bottom ground planes. The evaluation circuit board shown is available from Hittite upon request.