

# RT7310 Evaluate Report for Triac Dim Bulb EVB (Buck-Boost)

---

*ACDC BU / SLM Division  
August 2016*

<http://www.richtek.com/LED>

**RICHTEK**  
your power partner.

# RT7310 Brief Introduction

---

RT7310 is an active power factor correction controller specifically designed for using as a constant current LED driver.

Supporting:

Isolation: PSR Flyback

Non-isolation: PSR Buck-Boost

**Applications** ➔ **TRIAC Dimmable LED Driver**



# RT7310 Features

---

## Phase-Cut Dimmable Primary-Side Regulation LED Driver Controller with Active PFC

- Primary Side Regulation(PSR)
- Power Factor Correction(PFC)
- Critical conduction mode(CRM)
- Max/Min switch frequency clamping
- Max/Min on time limitation
- THD Optimization
- Supporting Phase-Cut Dimmers

# RT7310 Advantage

---

- Tight LED Current Regulation
- Protection:
  - a. LED open-circuit protection
  - b. LED short-circuit protection
  - c. Output diode short-circuit protection
  - d. Vdd under/over voltage protection
  - e. Over temperature protection
  - f. Cycle-by-cycle current limitation

# Circuit

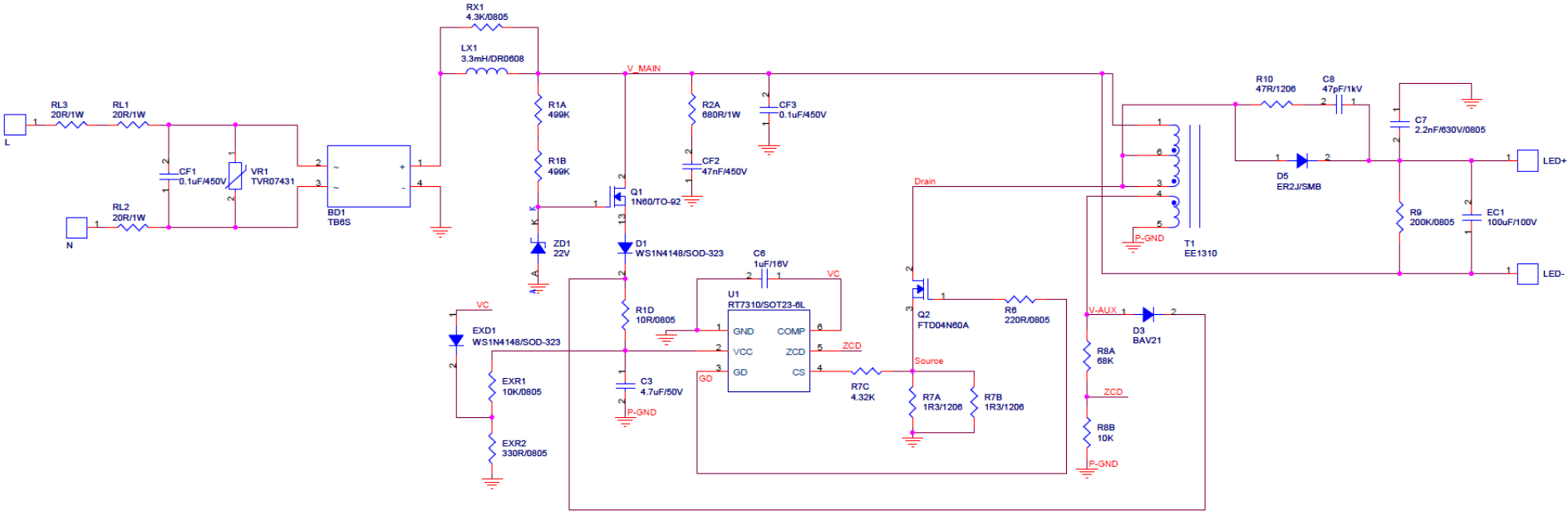

# Electrical Performance

Load: LED 24 Series without dimmer

Line filter off

Frequency	Vac [V]	Iac [mA]	Pin [Watt]	V-LED [V]	I-LED[mA]	Eff. [%]	PF	THDi
50Hz	180	78	13.71	76.15	160	88.87%	0.9640	14.2000
50Hz	200	77	14.7	76.42	171	88.90%	0.9530	15.0000
50Hz	220	73	15.15	76.55	176	88.93%	0.9390	15.8700
50Hz	230	70	15.23	76.58	177	89.00%	0.9320	16.3200
50Hz	240	68	15.3	76.57	178	89.08%	0.9230	16.7700
50Hz	264	64	15.46	76.62	179	88.71%	0.9000	17.8800

180~264Vac current regulation = 10.61% (+/-5.31%)

220~240Vac current regulation = 1.12% (+/-0.56%)

△ Efficiency = 0.37%

Maximum PFC = 0.964

Minimum PFC = 0.900

# Efficiency

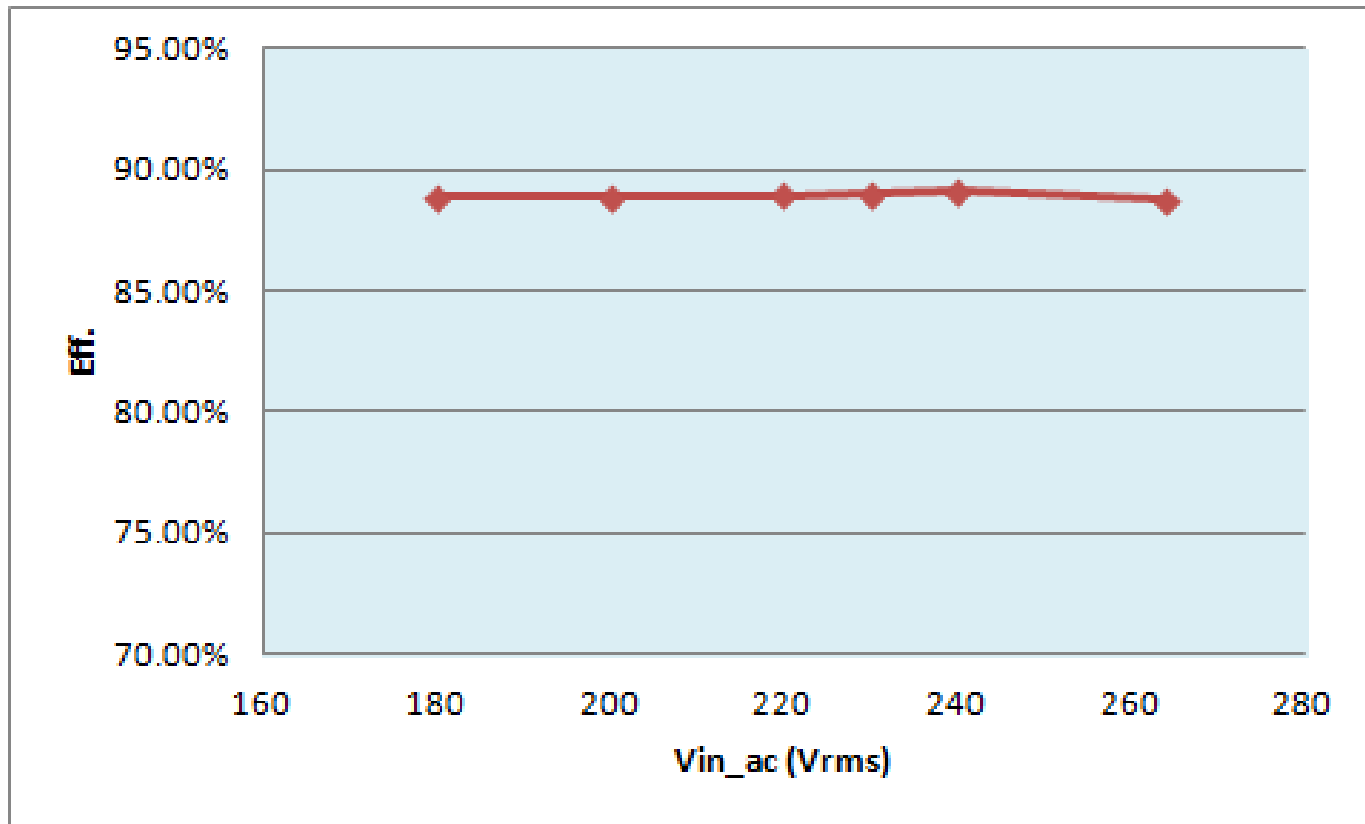

# Power Factor

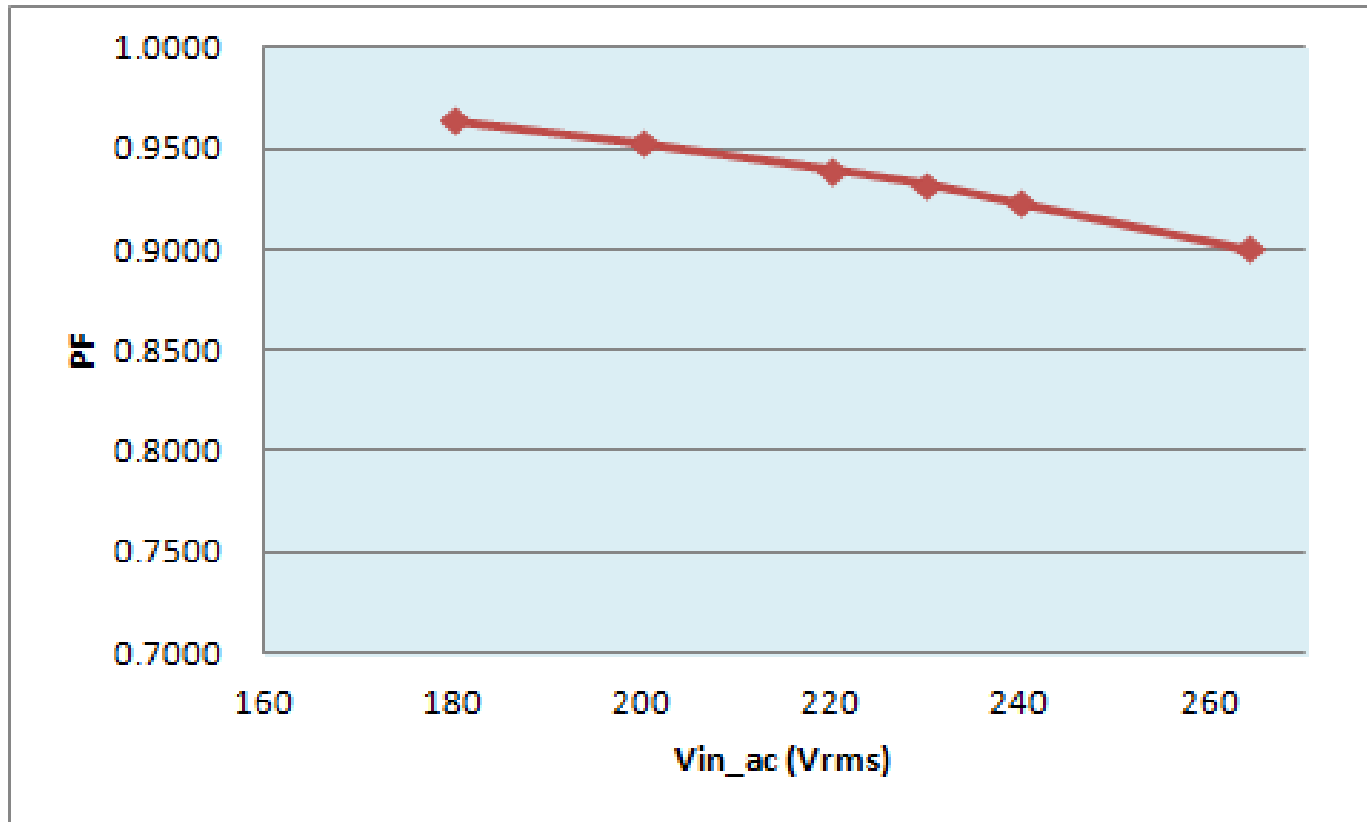



# Current Regulation

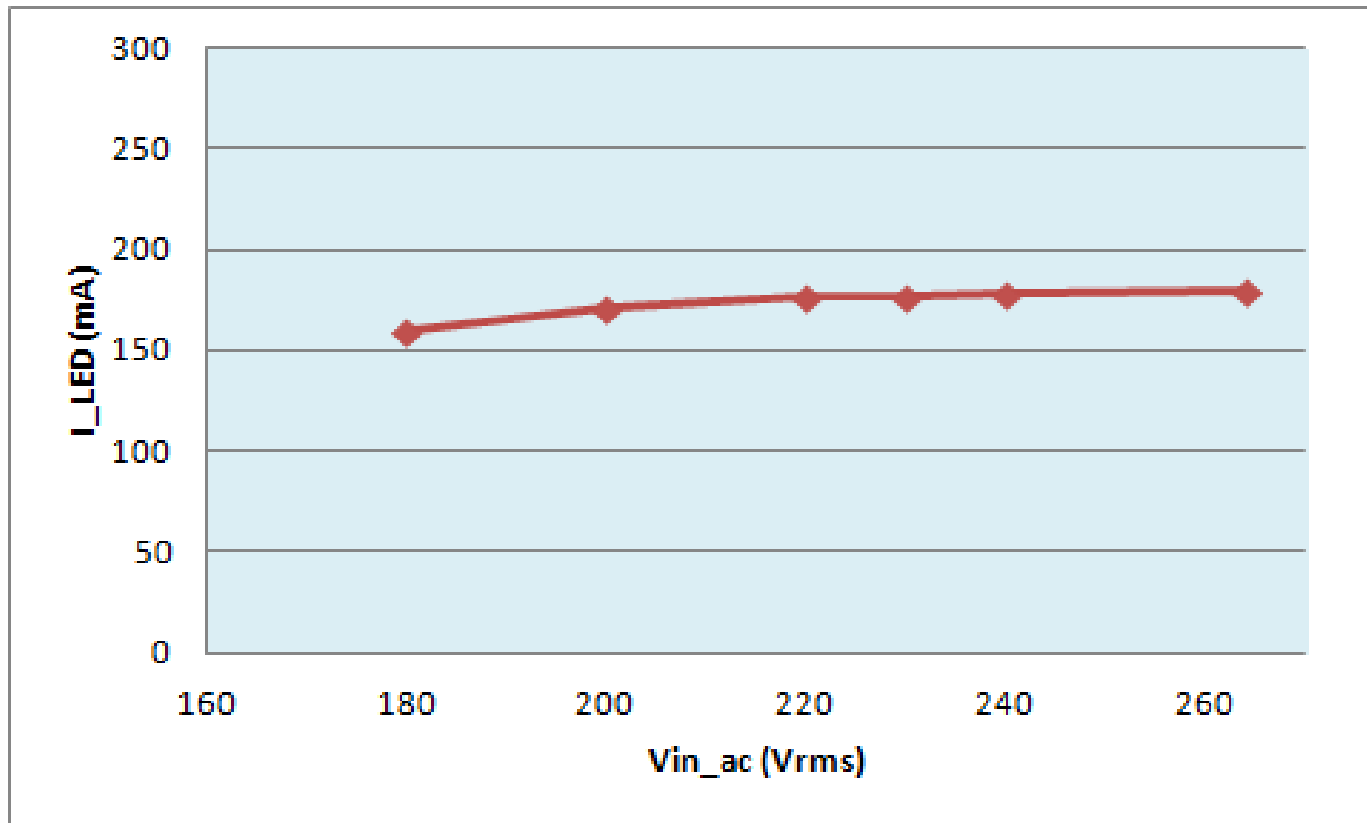

# Load Regulation

Frequency	Vac [V]	Vout [V]	Iout [mA]	Load Regulation
60Hz	220	71.11	177	0.55%
60Hz	220	74.28	176	
60Hz	220	77.25	176	

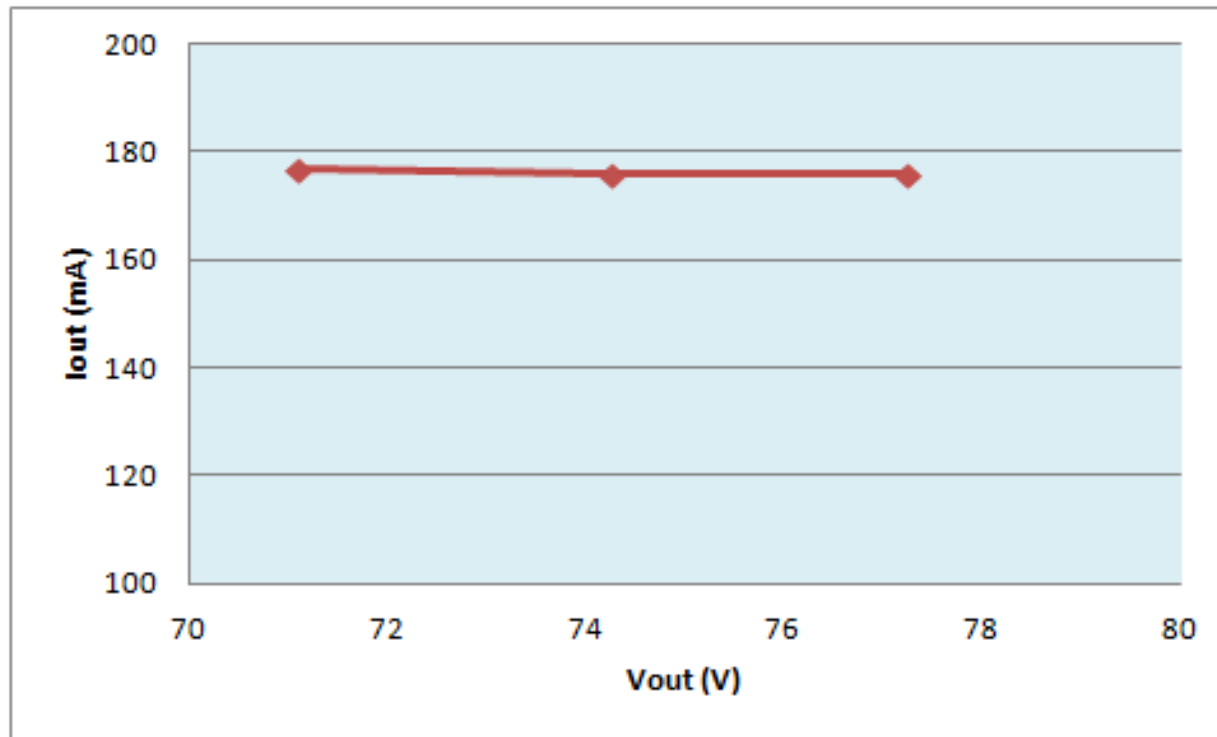

# Triac Dimmer Compatibility

Item	Brand	Model	Load MAX. (Unit:W)	Poles	Dimming Range (in watts)	Led current Range (Unit:mA)	Flickering situation	Brightness duty_min (Unit: %)
1	全本電工	K9051	630W 230V / 50Hz	Single way	15.11 - 5.81	177 - 54	No	30.51%
2	奇電	HZ8601	160W 230V / 50Hz	Single way	14.95 - 4.81	177 - 42	No	23.73%
3	曼科	Unknow	200W 230V/ 50Hz	Single way	14.85 - 5.11	177 - 45	No	25.42%
4	西蒙	6101	500W 230V / 50Hz	Single way	14.95 - 4.71	177 - 40	No	22.60%
5	白牌	A36	200W 230Vac 50Hz	Single way	14.95 - 5.7	177 - 53	No	29.94%
6	巴頓	B90022	200W 230Vac 50Hz	Single way	14.95 - 5.35	177 - 48	No	27.12%
7	TCL	LM2	630W 230V / 50Hz	Single way	15.1 - 3.43	177 - 25	No	14.12%
8	SIEMENS	Unknow	400W 230V / 50Hz	Single way	15.01 - 5.53	177 - 53	No	29.94%
9	勝本	Unknow	500W 230V / 52Hz	Single way	15.24 - 4.22	177 - 34	No	19.21%
10	GIRA	Unknow	420W 230Vac 50Hz trailing edge	Single way	15.09 - 4.74	177 - 52	No	29.38%
11	松本電工	B90B	500W 220Vac 50Hz	Single way	15.09 - 0.1	177 - 0	<10mA slow flicker	0.00%
12	TCL	V8051	630W 230V / 54Hz	Single way	14.91 - 1.86	177 - 9	<15mA slow flicker	5.08%

# PCB Layout

TOP Layer

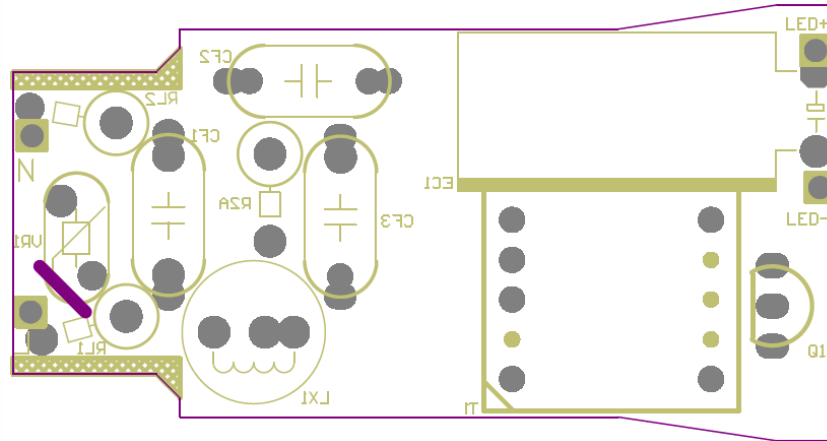

BOT Layer

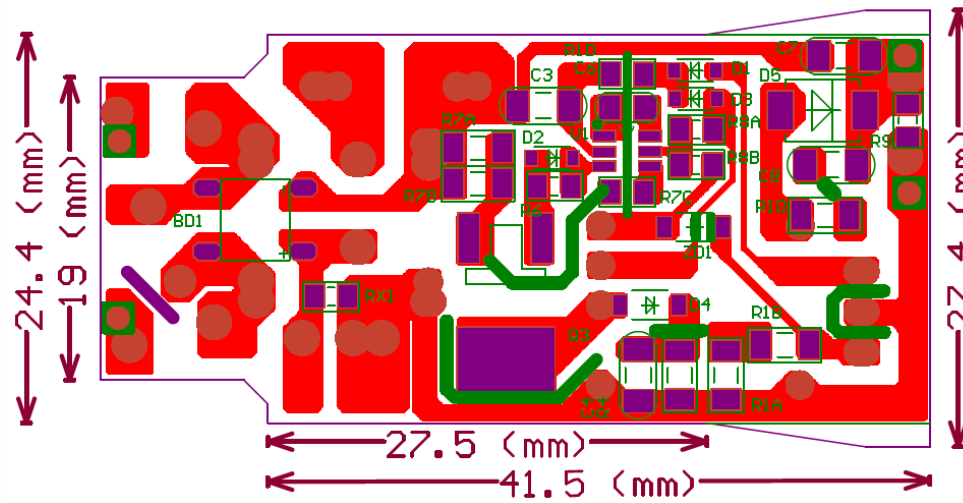

# Demo Board Photo

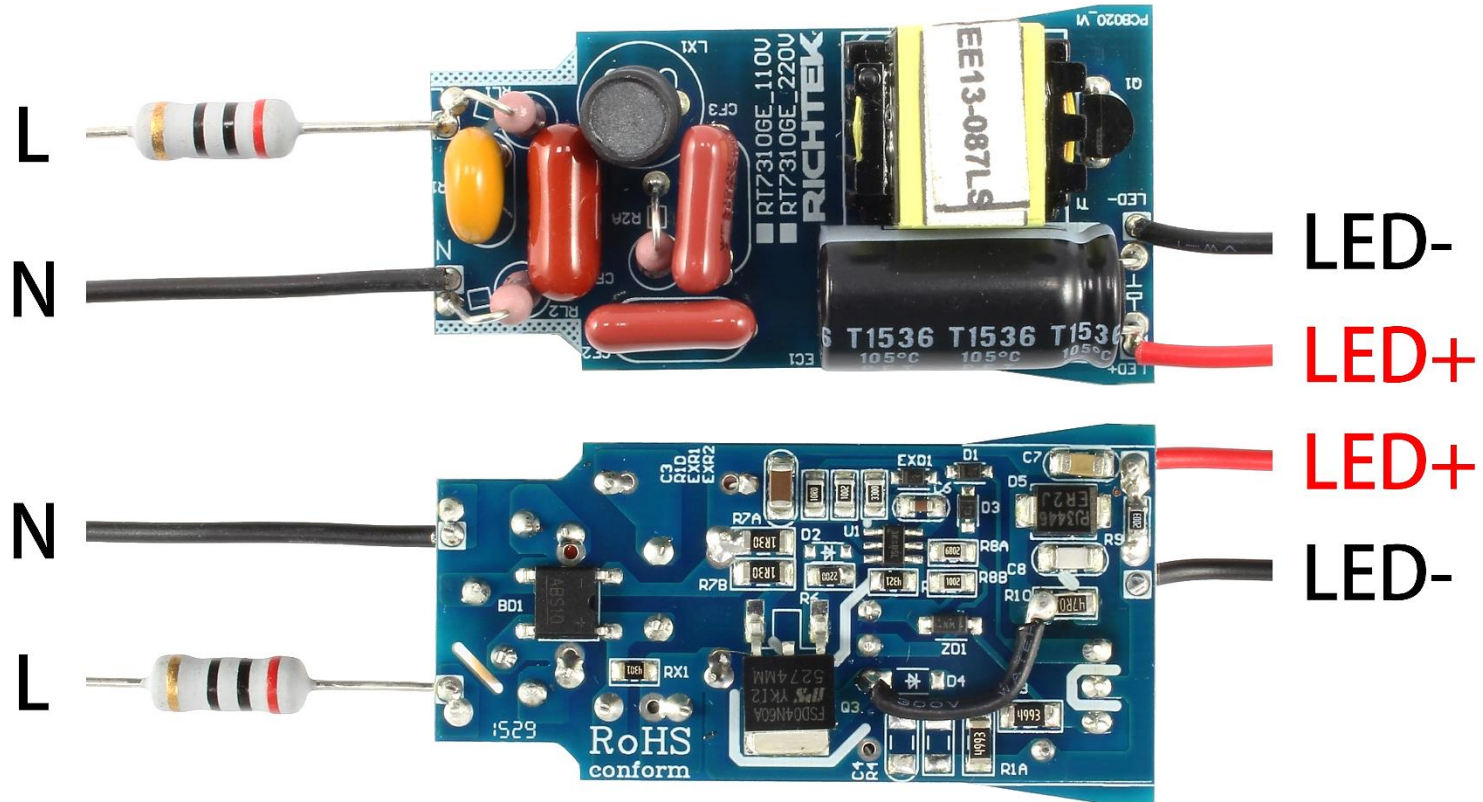

PCB No : PCB020\_V1

# BOM

Item	Location	Value	Type
1	RL1 RL2 RL3	20R/1W	R1WR_P5
2	VR1	TVR07431	CAP-7MM-CYR
3	BD1	TB6S	TBS
4	U1	RT7310	SOT23-6L
5	LX1	3.3mH	DR0608
6	T1	1000uH	EE1310
7	Q1	01N60F	TO-92
8	Q2	FTD04N60A	TO-252
9	D1 EXD1	WS1N4148	SOD-323
10	D3	BAV21	SOD-323
11	D5	ER2J	SMB
12	ZD1	22V	SOD-123

# BOM

Item	Location	Value	Type
13	CF1	47nF/450V	CL21-7.5/10LE-D
14	CF2	0.1uF/450V	CL21-7.5/10LE-D
15	CF3	0.1uF/450V	CL21-7.5/10LE-D
16	C3	4.7uF/50V	1206
17	C6	1uF/16V	0805
18	C7	2.2nF/630V	1206
19	C8	47pF/630V	1206
20	EC1	100uF/100V	CB10*20LD
21	R1A	499K	1206
22	R1D	10R	0805
23	R2A	680R/1W	R4*5.5LE
24	R6	220R	0805

# BOM

Item	Location	Value	Type
25	R7A R7B	1R3	1206
26	R7C	4.3K	0805
27	R8A	68K	0805
28	R8B RXR1	10K	0805
29	R9	200K	0805
30	R10	47R	1206
31	RX1	4.3K	0805
32	EXR2	330R	0805

Total: 37pcs

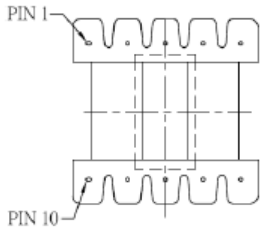

# Transformer

Vender :	豐達		
CORE SIZE:	EE1310	Material:	PC40
Bobbin/PINs:	Vertical / 10 pins		
Primary inductor: (+-10%)	1000uH		
Leakage inductor:	N/A		
Test condition:	1kHz/1V		
Varnish :	Yes		
Electrical :	<p style="text-align: center;">Bottom View</p> 		

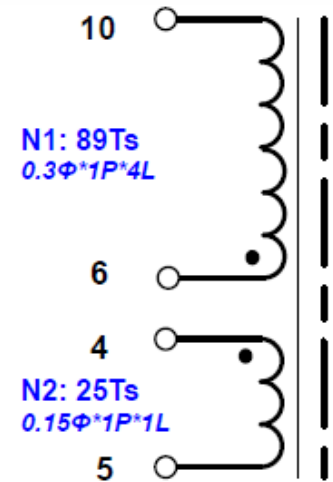
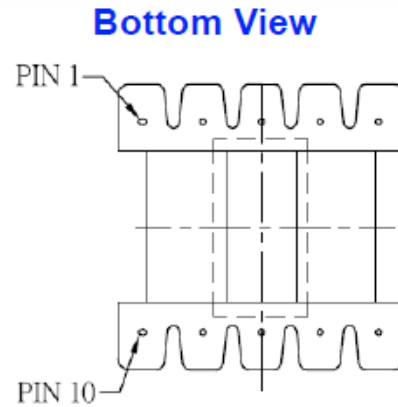

Winding No. (組別)	PIN (腳位)	Wire & Wire & Copper (線徑 x 股數 x 層數)	Turns (圈數)	Winding Type (繞線方式)	Tape Layer (膠帶層次)
<i>Bobbin</i>					
N1	6 → 10	0.3x 1P x 4L	89Ts	密繞	2L
N2	4 → 5	0.15 x 1P x 1L	25Ts	密繞	2L
<i>Core - EE1310</i>				1000uH	

# Power Component Voltage Stress

**Test condition: 264Vac/50Hz input / 75V, 180mA output**

Stead state			
Location	Max rating (V)	Measure	De-rating
Q1	600	496	83%
D1	600	484	81%

Transient State			
Location	Max rating (V)	Measure	De-rating
Q1	600	496	83%
D1	600	484	81%

# LED Open Protection

$V_{ac\_in} = 220V$

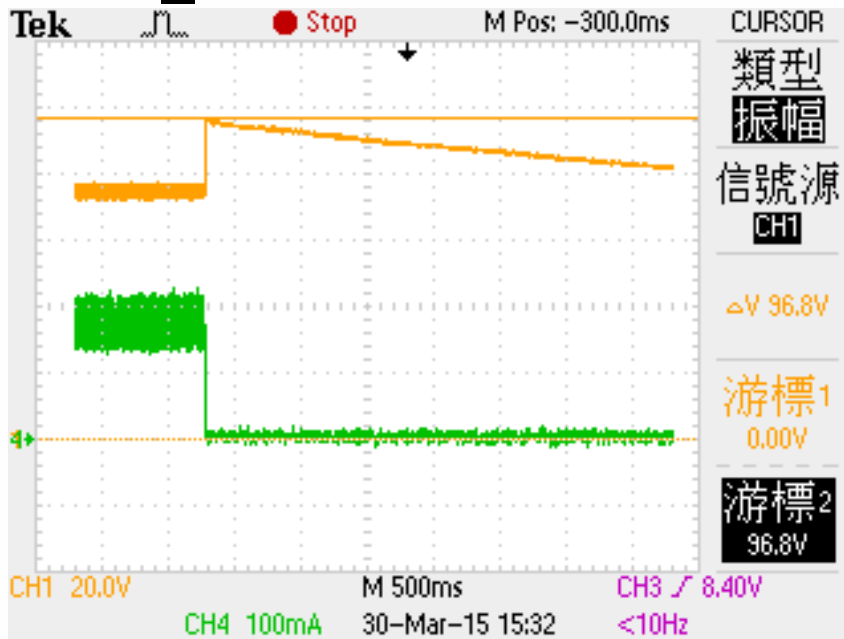

CH1:I\_LED, CH4:V\_LED

When LED open, the output keeps rising and causing the  $V_{ZCD}$  rising accordingly. If  $V_{zcd}$  trigger the protected level (2.9V~3.3V), the IC latch down.

# LED Short Protection

Vac\_in = 220V

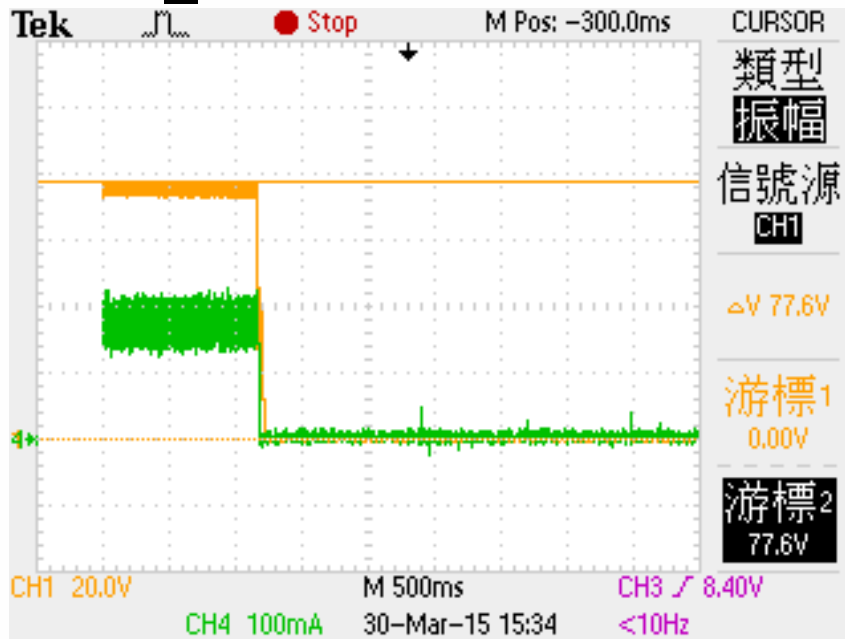

CH1:I\_LED, CH4:V\_LED

When LED short , the output level is 0V and the Vcs will rise to trigger the protected function. IC will be auto-restarted when the output is recovered.

# Harmonic(IEC61000-3-2)

**220Vac input**  
**Class C : Pass**  
**Class D : Pass**

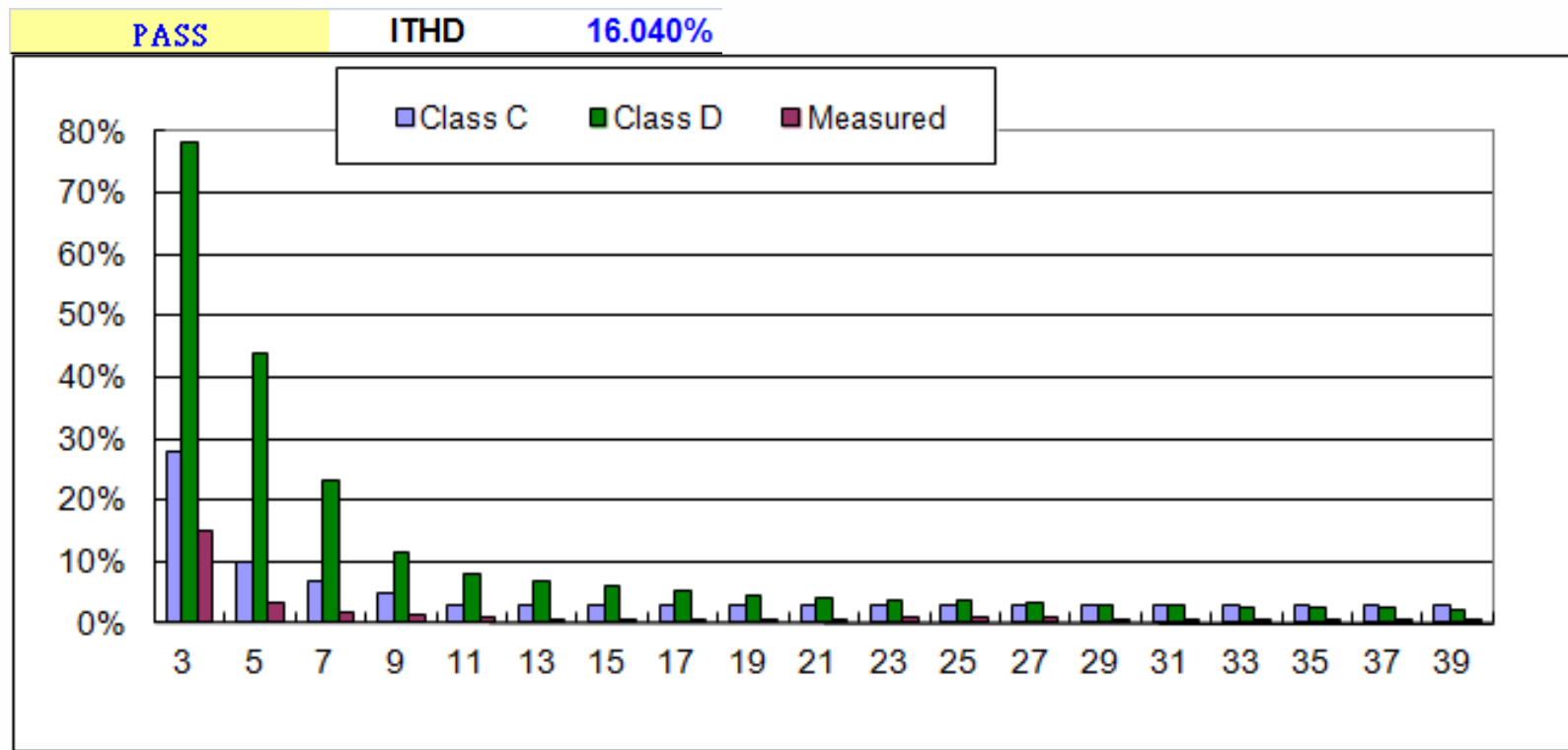

# Conduction EMI (1)

220Vac/50Hz-L1 → Pass

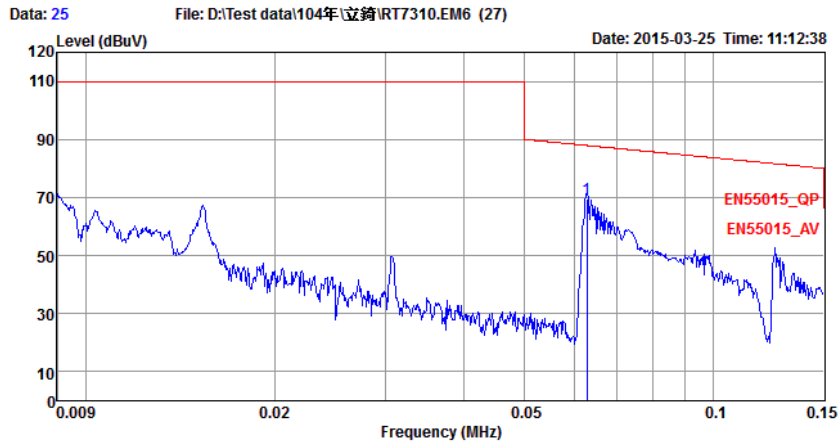

Condition: EN55015\_QP LISN-03-09-2015 NEUTRAL  
 Engineer : Parody  
 EUT : RT7310  
 Power : 220V  
 Mode :  
 Mome1 :  
 Mome2 :  
 Mome3 :  
 Mome4 :

	Freq	Level	Over Limit	Limit Line	Read Level	LISN Factor	Cable Loss	Pol/Phase	Remark
	MHz	dBuV	dB	dBuV	dBuV	dB	dB		
1 pp	0.06	69.72	-18.19	87.91	59.88	9.82	0.02	NEUTRAL	QP

220Vac/50Hz-L2 → Pass

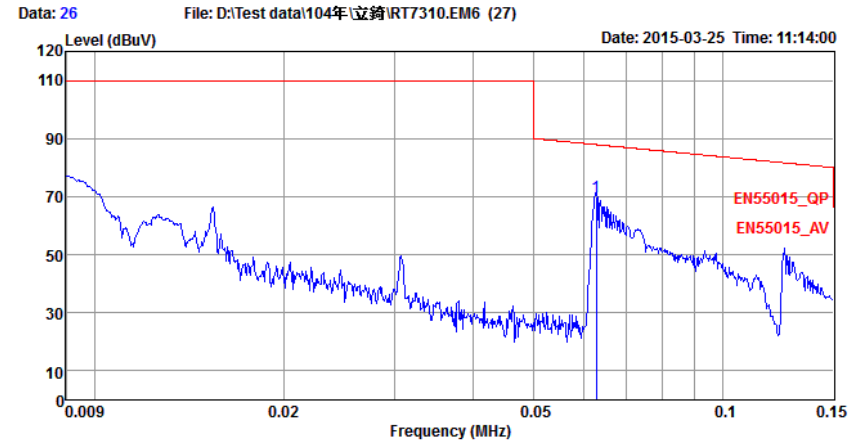

Condition: EN55015\_QP LISN-03-09-2015 LINE  
 Engineer : Parody  
 EUT : RT7310  
 Power : 220V  
 Mode :  
 Mome1 :  
 Mome2 :  
 Mome3 :  
 Mome4 :

	Freq	Level	Over Limit	Limit Line	Read Level	LISN Factor	Cable Loss	Pol/Phase	Remark
	MHz	dBuV	dB	dBuV	dBuV	dB	dB		
1 pp	0.06	69.85	-18.06	87.91	59.86	9.97	0.02	LINE	QP

# Conduction EMI (2)



## 220Vac/50Hz-L1 → Pass

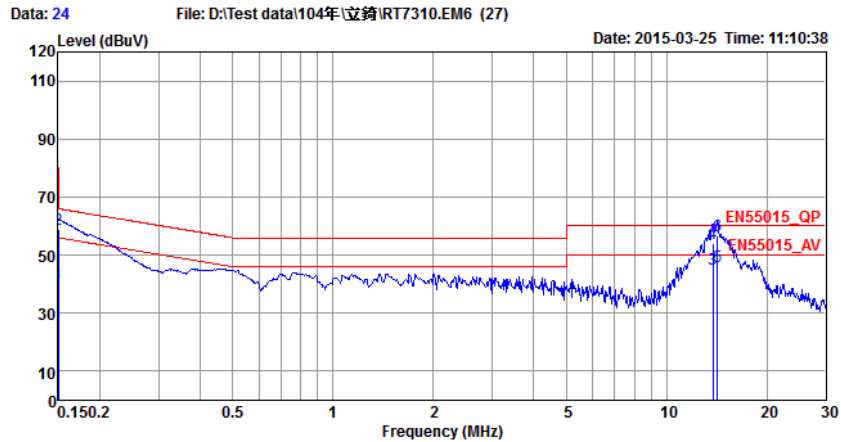

Condition: EN55015\_QP LISN-03-09-2015 NEUTRAL  
 Engineer : Parody  
 EUT : RT7310  
 Power : 220V  
 Mode :  
 Mome1 :  
 Mome2 :  
 Mome3 :  
 Mome4 :

	Freq	Level	Over Limit	Limit Line	Read Level	LISN Factor	Cable Loss	Pol/Phase	Remark
	MHz	dBuV	dB	dBuV	dBuV	dB	dB		
1	0.15	40.20	-15.80	56.00	30.40	9.78	0.02	NEUTRAL	Average
2	0.15	59.04	-6.96	66.00	49.24	9.78	0.02	NEUTRAL	QP
3	13.77	45.35	-4.65	50.00	35.01	10.09	0.25	NEUTRAL	Average
4	13.77	53.86	-6.14	60.00	43.52	10.09	0.25	NEUTRAL	QP
5	av	14.19	45.89	-4.11	50.00	35.54	10.10	0.25	NEUTRAL
6	pp	14.19	56.59	-3.41	60.00	46.24	10.10	0.25	NEUTRAL



## 220Vac/50Hz-L2 → Pass

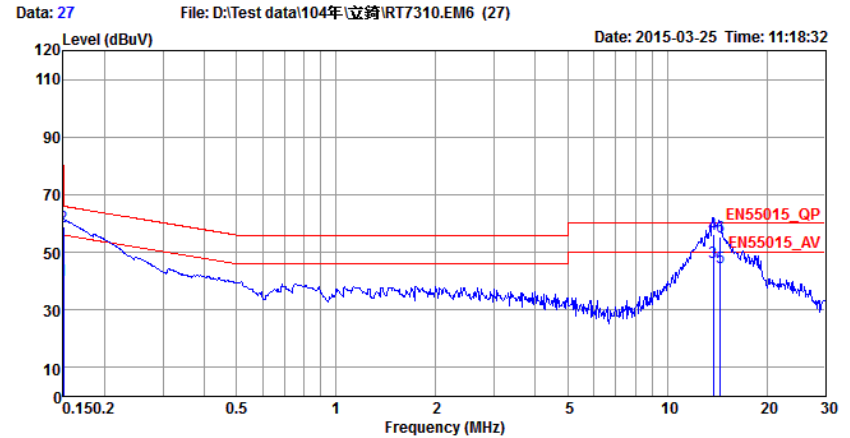

Condition: EN55015\_QP LISN-03-09-2015 LINE  
 Engineer : Parody  
 EUT : RT7310  
 Power : 220V  
 Mode :  
 Mome1 :  
 Mome2 :  
 Mome3 :  
 Mome4 :

	Freq	Level	Over Limit	Limit Line	Read Level	LISN Factor	Cable Loss	Pol/Phase	Remark
	MHz	dBuV	dB	dBuV	dBuV	dB	dB		
1	0.15	40.16	-15.84	56.00	30.21	9.93	0.02	LINE	Average
2	0.15	58.93	-7.07	66.00	48.98	9.93	0.02	LINE	QP
3	pp	13.76	46.47	-3.53	50.00	35.92	10.30	0.25	LINE
4	qp	13.76	56.21	-3.79	60.00	45.66	10.30	0.25	LINE
5		14.44	44.51	-5.49	50.00	33.93	10.32	0.26	LINE
6		14.44	55.37	-4.63	60.00	44.79	10.32	0.26	LINE

# Radiation EMI

## 220Vac/50Hz-V → Pass



No. 8 Lane 724, Bo Ai Street, Zhubei City,  
Hsin Chu Hsien 302, Taiwan, R.O.C.  
TEL:03-656-9065  
FAX:03-656-9085



No. 8 Lane 724, Bo Ai Street, Zhubei City,  
Hsin Chu Hsien 302, Taiwan, R.O.C.  
TEL:03-656-9065  
FAX:03-656-9085

Data: 7 File: E:\客戶 data\立錡\RT7310.EM6 (7)

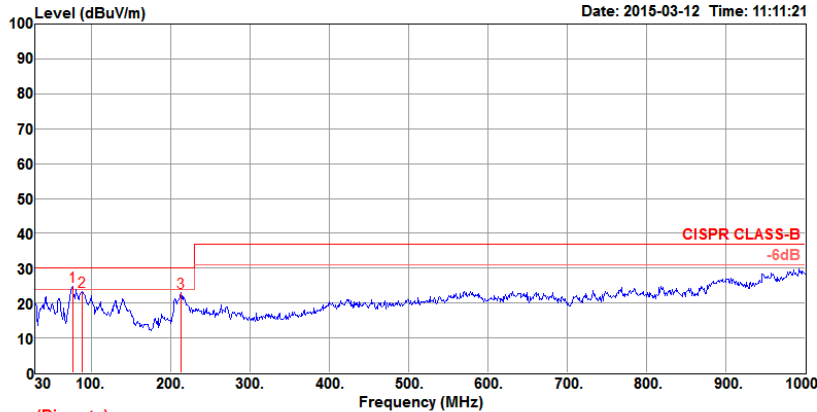

Trace: (Discrete)  
Condition: CISPR CLASS-B 10m BILOG ANT 20141111 VERTICAL  
: RBW:100.000KHz VBW:300.000KHz SWT:0.500sec  
Engineer : Hank  
Eut : RT7310  
Mode : Normal  
Power : AC 220V/60Hz  
Memo 5-1 : 220R  
Memo 5-2 :

	Freq	Level	Limit	Over	Read	Cable	Antenna	Preamp	A/Pos	T/Pos	Remark	Pol/Phase
	MHz	dBuV/m	dBuV/m	dB	dBuV	dB	dB/m	dB	cm	deg		
1	76.56	24.76	30.00	-5.24	54.39	0.76	7.31	32.17	100	231	Peak	VERTICAL
2	89.17	23.42	30.00	-6.58	49.29	0.82	9.04	32.23	100	231	Peak	VERTICAL
3	213.33	23.14	30.00	-6.86	43.08	1.27	10.77	32.05	200	135	Peak	VERTICAL

Data: 6 File: E:\客戶 data\立錡\RT7310.EM6 (7)

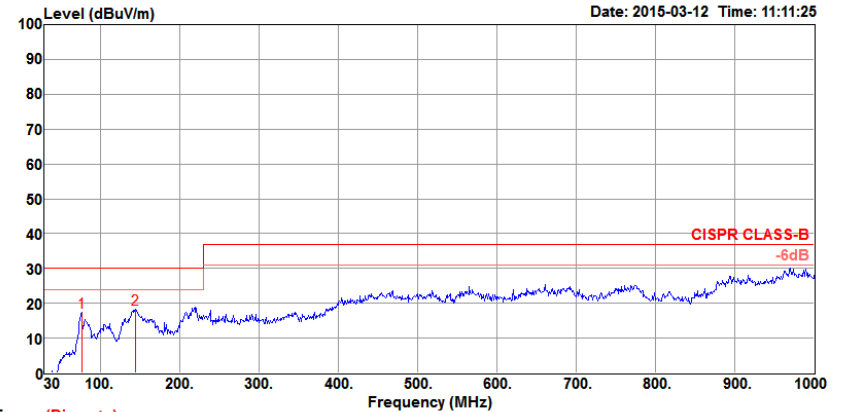

Trace: (Discrete)  
Condition: CISPR CLASS-B 10m BILOG ANT 20141111 HORIZONTAL  
: RBW:100.000KHz VBW:300.000KHz SWT:0.500sec  
Engineer : Hank  
Eut : RT7310  
Mode : Normal  
Power : AC 220V/60Hz  
Memo 5-1 : 220R  
Memo 5-2 :

	Freq	Level	Limit	Over	Read	Cable	Antenna	Preamp	A/Pos	T/Pos	Remark	Pol/Phase
	MHz	dBuV/m	dBuV/m	dB	dBuV	dB	dB/m	dB	cm	deg		
1	76.56	17.51	30.00	-12.49	52.82	0.76	7.31	32.17	200	186	Peak	HORIZONTAL
2	144.46	18.18	30.00	-11.82	45.80	1.05	11.69	32.16	200	164	Peak	HORIZONTAL



**RICHTEK**  
your power partner.

thank you.