

Features

- Guard Ring Die Construction for Transient Protection
- Low Power Loss, High Efficiency
- High Surge Capability
- Very Low Forward Voltage Drop
- For Use in Low Voltage, High Frequency Inverters, OR'ing, and Polarity Protection Applications
- Plastic Material: UL Flammability Classification Rating 94V-0

Mechanical Data

- Case: DPAK Molded Plastic
- Terminals: Solderable per MIL-STD-202, Method 208
- Polarity: See Diagram
- Marking: See Sheet 2
- Weight: 0.4 grams (approx.)
- Ordering Information, See Below

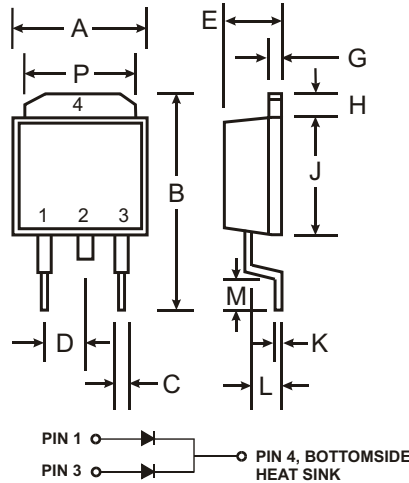

DPAK		
Dim	Min	Max
A	6.3	6.7
B	—	10
C	0.3	0.8
D	2.3 Nominal	
E	2.1	2.5
G	0.4	0.6
H	1.2	1.6
J	5.3	5.7
K	0.5 Nominal	
L	1.3	1.8
M	1.0	—
P	5.1	5.5
All Dimensions in mm		

Maximum Ratings @ T_A = 25°C unless otherwise specified

Single phase, half wave, 60Hz, resistive or inductive load.
For capacitive load, derate current by 20%.

Characteristic	Symbol	Value	Unit
Peak Repetitive Reverse Voltage Working Peak Reverse Voltage DC Blocking Voltage	V _{RRM} V _{RWM} V _R	40	V
RMS Reverse Voltage	V _{R(RMS)}	28	V
Average Rectified Output Current (See Figure 4)	I _o	5 10	A
Non-Repetitive Peak Forward Surge Current 8.3ms Single half sine-wave Superimposed on Rated Load Per Package (JEDEC Method)	I _{FSM}	75	A
Typical Thermal Resistance Junction to Case Per Element (Note 1)	R _{θJC}	2.43	°C/W
Voltage Rate of Change @ V _R = 35V, T _j = 25°C	dv/dt	10,000	V/μs
Operating Temperature Range	T _j	-55 to +125	°C
Storage Temperature Range	T _{STG}	-55 to +150	°C

Notes: 1. Device mounted on PC board with 14mm² (.013mm thick) copper pad areas.

Ordering Information (Note 2)

Device	Packaging	Shipping
MBRD1040CT-T	DPAK	2500/Tape & Reel

Notes: 2. For Packaging Details, go to our website at <http://www.diodes.com/datasheets/ap02007.pdf>.

Electrical Characteristics @ $T_A = 25^\circ\text{C}$ unless otherwise specified

Characteristic	Symbol	Min	Typ	Max	Unit	Test Condition
Reverse Breakdown Voltage (Note 2)	$V_{(BR)R}$	40	—	—	V	$I_R = 500\mu\text{A}$
Forward Voltage (Note 2)	V_{FM}	—	0.46	0.48 0.41 0.53 0.57 0.55	V	$I_F = 5\text{A}, T_S = 25^\circ\text{C}$ $I_F = 5\text{A}, T_S = 100^\circ\text{C}$ $I_F = 10\text{A}, T_S = 25^\circ\text{C}$ $I_F = 10\text{A}, T_S = 100^\circ\text{C}$
Peak Reverse Current (Note 2)	I_{RM}	—	60	150 10 80 3	μA mA μA mA	$V_R = 35\text{V}, T_j = 25^\circ\text{C}$ $V_R = 35\text{V}, T_j = 100^\circ\text{C}$ $V_R = 17.5\text{V}, T_j = 25^\circ\text{C}$ $V_R = 17.5\text{V}, T_j = 100^\circ\text{C}$
Typical Junction Capacitance	C_j	—	500	—	pF	$f = 1.0\text{MHz}, V_R = 4.0\text{V DC}$

Notes: 1. Device mounted on PC board with 14mm^2 (.013mm thick) copper pad areas.
2. Short duration test pulse used to minimize self-heating effect.

Marking Information

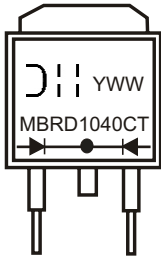

MBRD1040CT = Product type marking code
 D = Manufacturers' code marking
 YWW = Date code marking
 Y = Last digit of year ex: 2 for 2002
 WW = Week code 01 to 52

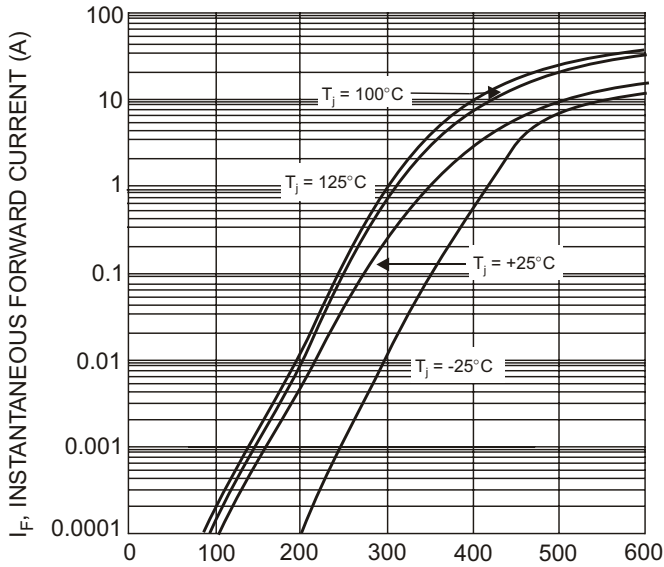

V_F , INSTANTANEOUS FORWARD VOLTAGE (mV)
 Fig. 1 Typical Forward Characteristics (per element)

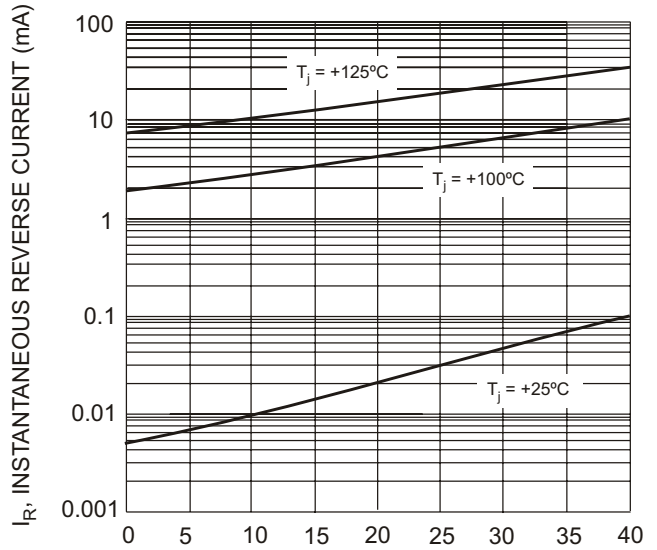

V_R , INSTANTANEOUS REVERSE VOLTAGE (V)
 Fig. 2 Typical Reverse Characteristics (Per Element)

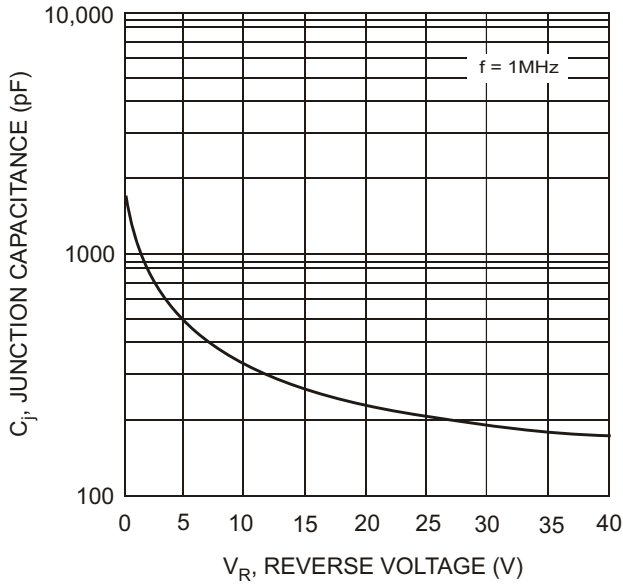

Fig. 3 Typical Junction Capacitance vs. Reverse Voltage

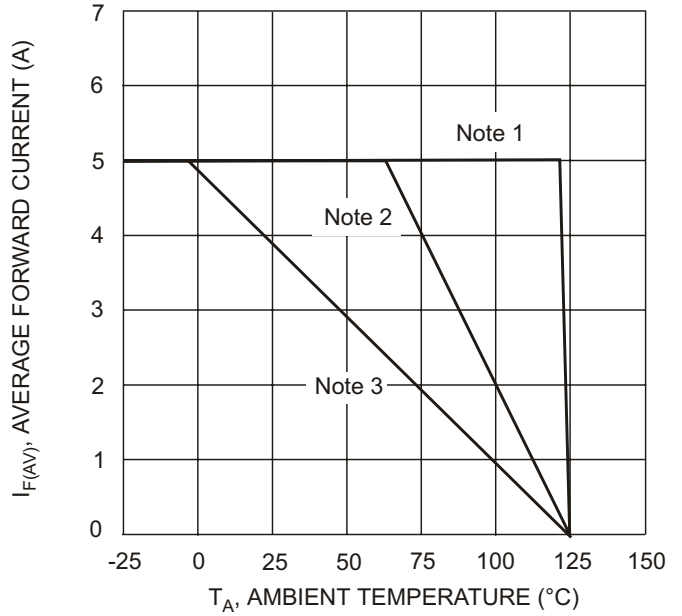

Fig. 4 DC Forward Current Derating (Per Element)

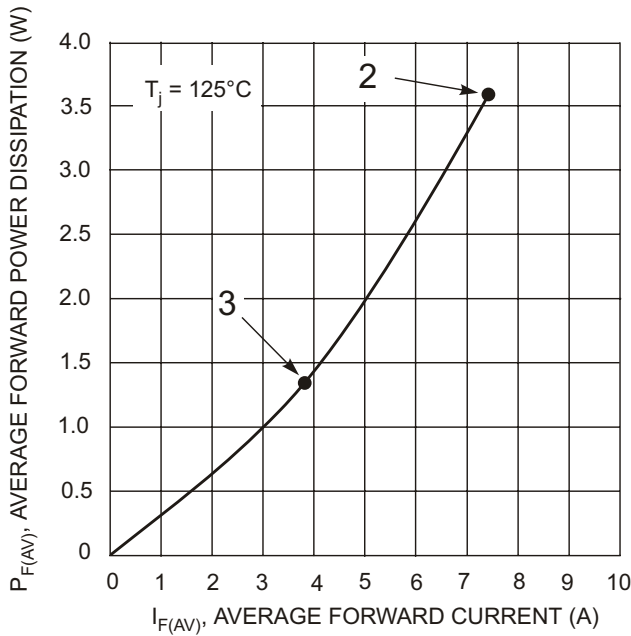

Fig. 5 Forward Power Dissipation (Per Element)

- Notes:
1. $T_A = T_{\text{SOLDERING POINT}}$, $R_{\theta JC} = 2.43^\circ\text{C/W}$, $R_{\theta CA} = 0^\circ\text{C/W}$.
 2. Device mounted on GETEK substrate, 2"x2", 2 oz. copper, double-sided, cathode pad dimensions 0.75" x 1.0", anode pad dimensions 0.25" x 1.0". $R_{\theta JA}$ in range of 15-30°C/W.
 3. Device mounted on FR-4 substrate, 2"x2", 2 oz. copper, single-sided, pad layout as per Diodes Inc. suggested pad layout document AP02001 which can be found on our website at <http://www.diodes.com/datasheets/ap02001.pdf>. $R_{\theta JA}$ in range of 60-75°C/W.