

注記  
NOTES:

- 材質  
MATERIAL  
ハウジング: LCP (液晶ポリマー)、ガラス充填、黒色、UL 94V-0  
HOUSING: LCP (LIQUID CRYSTAL POLYMER), GLASS FILLED, BLACK, UL 94V-0  
ターミナル: 銅合金 (t=0.15)  
TERMINAL: COPPER ALLOY (t=0.15)  
ネイル: 銅合金 (t=0.2)  
NAIL: COPPER ALLOY (t=0.2)  
カバーテープ: ポリイミド (t=0.08)  
VACUUM TAPE: POLYIMIDE (t=0.08)
- メッキ仕様  
PLATING  
ターミナル  
TERMINAL  
接点部: 金メッキ 0.25マイクロメートル以上  
CONTACT AREA: GOLD 0.25 MICROMETER MINIMUM  
半田付け部: 金メッキ 0.4マイクロメートル以上  
SOLDER TAIL AREA: GOLD 0.4 MICROMETER MAXIMUM  
下地メッキ: ニッケルメッキ 1.5マイクロメートル以上  
UNDER PLATING: NICKEL 1.5 MICROMETER MINIMUM  
ネイル  
NAIL  
半田メッキ 3.0マイクロメートル以上  
Sn-Pb 3.0 MICROMETER MINIMUM  
下地メッキ: 銅メッキ 1.0マイクロメートル以上  
UNDER PLATING: Cu 1.0 MICROMETER MINIMUM
- テール平坦度は、0.08ミリメートル以下。テールとネイルを併せた平坦度は、0.1ミリメートル以下。  
TAIL COPLANARITY TO BE 0.08 MAXIMUM. TAILS AND NAILS COPLANARITY TO BE 0.1 MAXIMUM.
- 嵌合相手: 55299-\*\*\*\* (H=3mm)  
MATED CONN.: 55201-\*\*\*\*, 55650-\*\*\*\* (H=2mm)  
55201-\*\*\*\*, 55650-\*\*\*\* (H=2mm)

40.5	41.9	39.5	43.9	54363-1604	54363-1602	160	—
35.5	36.9	34.5	38.9	54363-1404	54363-1402	140	○
30.5	31.9	29.5	33.9	54363-1204	54363-1202	120	○
25.5	26.9	24.5	28.9	54363-1004	54363-1002	100	○
23	24.4	22	26.4	54363-0904	54363-0902	90	—
20.5	21.9	19.5	23.9	54363-0804	54363-0802	80	—
18	19.4	17	21.4	54363-0704	54363-0702	70	—
15.5	16.9	14.5	18.9	54363-0604	54363-0602	60	○
13	14.4	12	16.4	54363-0504	54363-0502	50	○
10.5	11.9	9.5	13.9	54363-0404	54363-0402	40	○
8	9.4	7	11.4	54363-0304	54363-0302	30	○
5.5	6.9	4.5	8.9	54363-0204	54363-0202	20	○
D	C	B	A	エンボス梱包品 EMBOSSED TAPE PACKAGING	製品番号 MATERIAL NO.	極数 CIRCUITS	量産対応 AVAILABLE

REVISED EC NO.: J2016-0601 DRWN: JFURUKAWA 2015/12/08 CHKD: TASAKAWA 2015/12/08 APPR: KMORIKAWA 2015/12/16	GENERAL TOLERANCES (UNLESS SPECIFIED)		DIMENSION STYLE		SCALE	DESIGN UNITS	
	0.25 UNDER UNDER ±0.03		MM ONLY		10:1	METRIC	
	0.25 OVER 0.5 UNDER ±0.05		DRAWN BY DATE		TITLE		
	0.5 OVER 1.0 UNDER ±0.1		H. SHIMUYAMA 1997/11/17		0.5 PITCH B/B CONN. REC. HOUSING COVER ASSY (H=2,3) WITH FITTING NAIL		
	1.0 OVER 10 UNDER ±0.2		CHECKED BY DATE				
10 OVER 30 UNDER ±0.25		M. SASAO 1997/11/17					
30 OVER ±0.3		APPROVED BY DATE		MATERIAL NO.		DOCUMENT NO.	SHEET NO.
ANGULAR ±3 °				SEE CHART		SD-54363-004	1 OF 2
DRAFT WHERE APPLICABLE MUST REMAIN WITHIN DIMENSIONS		SIZE		THIS DRAWING CONTAINS INFORMATION THAT IS PROPRIETARY TO MOLEX ELECTRONIC TECHNOLOGIES, LLC AND SHOULD NOT BE USED WITHOUT WRITTEN PERMISSION			
		A3					

10 9 8 7 6 5 4 3 2 1

F

F

E

E

D

D

C

C

B

B

A

A

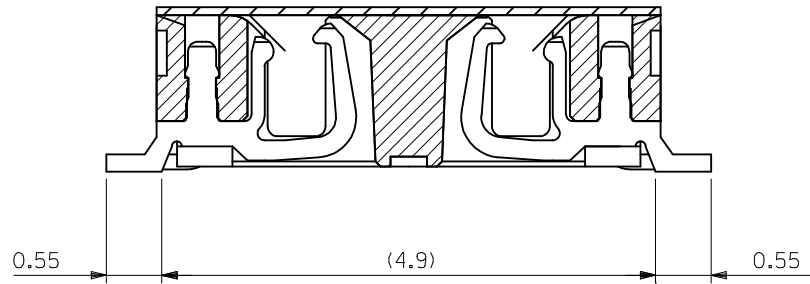

半田付け部詳細図  
DETAIL FOR SOLDERING AREA

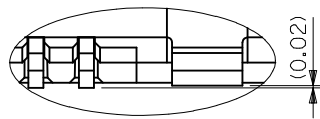

丁部詳細  
DETAIL T

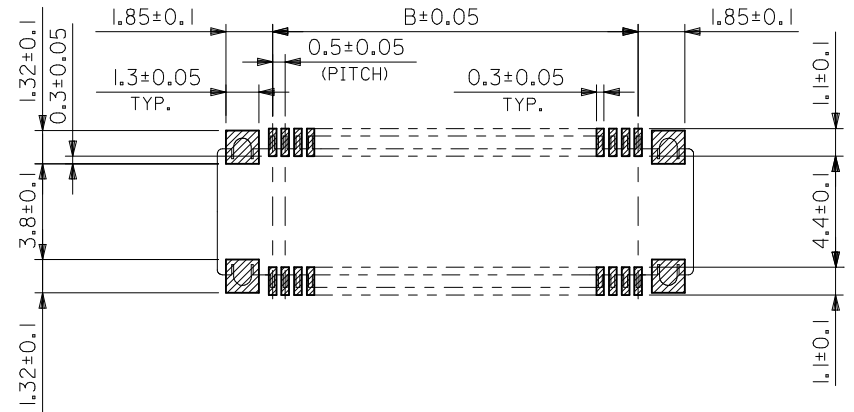

推奨基板寸法  
RECOMMENDED PCB PATTERN LAYOUT  
(SCALE:5-1)

9 8 7 6 5 4 3 2 1

REVISED EC NO: J2016-0601 DRWN: JFURUKAWA 2015/12/08 CHKD: TASAKAWA 2015/12/08 APPR: KMORIKAWA 2015/12/16	GENERAL TOLERANCES (UNLESS SPECIFIED)			DIMENSION STYLE MM ONLY		SCALE 20:1	DESIGN UNITS METRIC	THIRD ANGLE PROJECTION
	0.25 UNDER	UNDER	±0.03	DRAWN BY	DATE	TITLE		
	0.25 OVER	0.5 UNDER	±0.05	H. SHIMUYAMA	1997/11/17	0.5 PITCH B/B CONN. REC. HOUSING COVER ASSY (H=2,3) WITH FITTING NAIL		
	0.5 OVER	1.0 UNDER	±0.1	CHECKED BY	DATE	<b>molex</b> SD-54363-004 SHEET NO. 2 OF 2		
	1.0 OVER	10 UNDER	±0.2	M. SASAO	1997/11/17			
10 OVER	30 UNDER	±0.25	APPROVED BY	DATE	MATERIAL NO.	DOCUMENT NO.		
30 OVER		±0.3			SEE CHART			
	ANGULAR	±3 °	DRAFT WHERE APPLICABLE MUST REMAIN WITHIN DIMENSIONS		SIZE A3	THIS DRAWING CONTAINS INFORMATION THAT IS PROPRIETARY TO MOLEX ELECTRONIC TECHNOLOGIES, LLC AND SHOULD NOT BE USED WITHOUT WRITTEN PERMISSION		

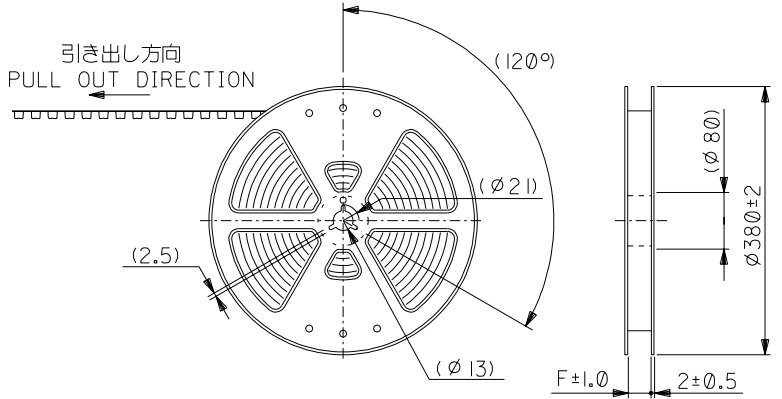

注)  
NOTES

- 製品番号 54363-\*\*\*2 詳細寸法については、製品単体図面を参照下さい。  
IN THE PACKAGE PART NUMBER 54363-\*\*\*2 DETAILED DIMENSIONS, SEE SALES DRAWING FOR CONNECTOR.
- 梱包数量：2500個/リール  
NUMBER OF CONNECTORS:2500 PCS/REEL.
- リードテープ長さ  
LEAD TAPE LENGTH

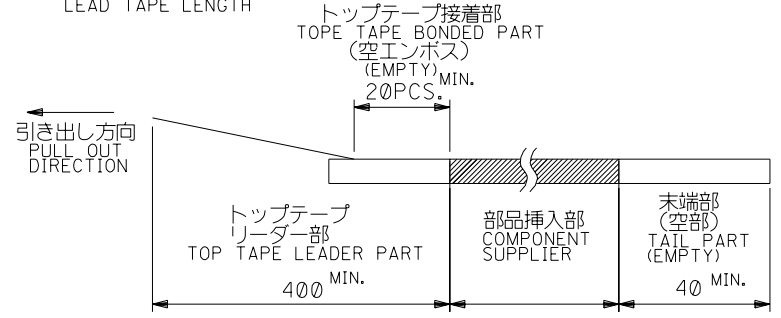

- トップテープの剥離強度：(剥離方向は下図参照)  
PEELING OFF FORCE OF TOP TAPE (PELLING DIRECTION AS SHOWN IN FOLLOWING FIGURE.)  
0. 1~1. 3N (10~130gf)

尚、本規格値は、出荷時に適用。  
THIS REQUIREMENT SHOULD BE APPLIED AT SHIPMENT.  
(但し、輸送時に剥離が発生しない事。)  
(PEEL OFF SHOULD NOT BE ALLOWED, DURING TRANSPORTATION.)

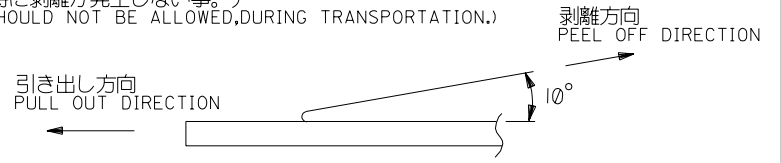

- 材料  
MATERIAL  
キャリアテープ：ポリプロピレン (PP)  
CARRIER TAPE: POLYPROPYLENE (PP)  
トップテープ：PET, PE, PEF  
TOP TAPE: PET, PE, PEF  
リール：ポリスチレン  
REEL: POLYSTYRENE

DO NOT SCALE DRAWING

EC NO. DRWN: CHK: APPR:	EC NO. DRWN: CHK: APPR:	REVISED ECNNO. J2003-1812 DRWN:SHIMOYAMA '03/01/14 CHK: K.KASAHARA '03/01/14 APPR:T.YAMAGUCHI '03/01/14	REVISED ECNNO. J2002-1629 DRWN:SHIMOYAMA '02/01/11 CHK: K.KASAHARA '02/01/11 APPR:T.YAMAGUCHI '02/01/11	REVISED ECNNO. JD2001-1201 DRWN:SHIMOYAMA '01/03/08 CHK: M.SASAO '01/03/08 APPR:H.IKESUGI '01/03/08	MATERIAL 材料 注記参照 SEE NOTES	GENERAL TOLERANCES: (UNLESS SPECIFIED) 一般公差	SCALE NONE	DESIGN UNITS <input checked="" type="checkbox"/> mm <input type="checkbox"/> INCH	THIRD ANGLE PROJECTION	DIMENSIONS: <input type="checkbox"/> mm <input type="checkbox"/> INCH <input checked="" type="checkbox"/> mm ONLY	SHT	REV	
					FINISH 仕上げ 注記参照 SEE NOTES	10 UNDER 未満	±0.2	DRAWN BY & DATE ShimoYama '97/11/21	TITLE: 54363-***2 TAPING PACKAGE				
G	F	E	REV	WIRE RANGE 適用層線範囲	10 OVER 以上	30 UNDER 未満	±0.25	CHECKED BY & DATE M. Sasao '97/11/21	MOLEX MOLEX INCORPORATED	MATERIAL NO. SEE CHART	DRAWING NO. SD-54363-005	SHEET NO. 1 OF 2	
				INS. RANGE 被覆外径	30 OVER 以上	±0.3	APPROVED BY & DATE ShimoYama '97/11/21						
8	7	6	5	4	3	2	1	THIS DRAWING CONTAINS INFORMATION THAT IS PROPRIETARY TO MOLEX INCORPORATED AND SHOULD NOT BE USED WITHOUT WRITTEN PERMISSION.					SIZE B

DWG. NO.  
SD-54363-005

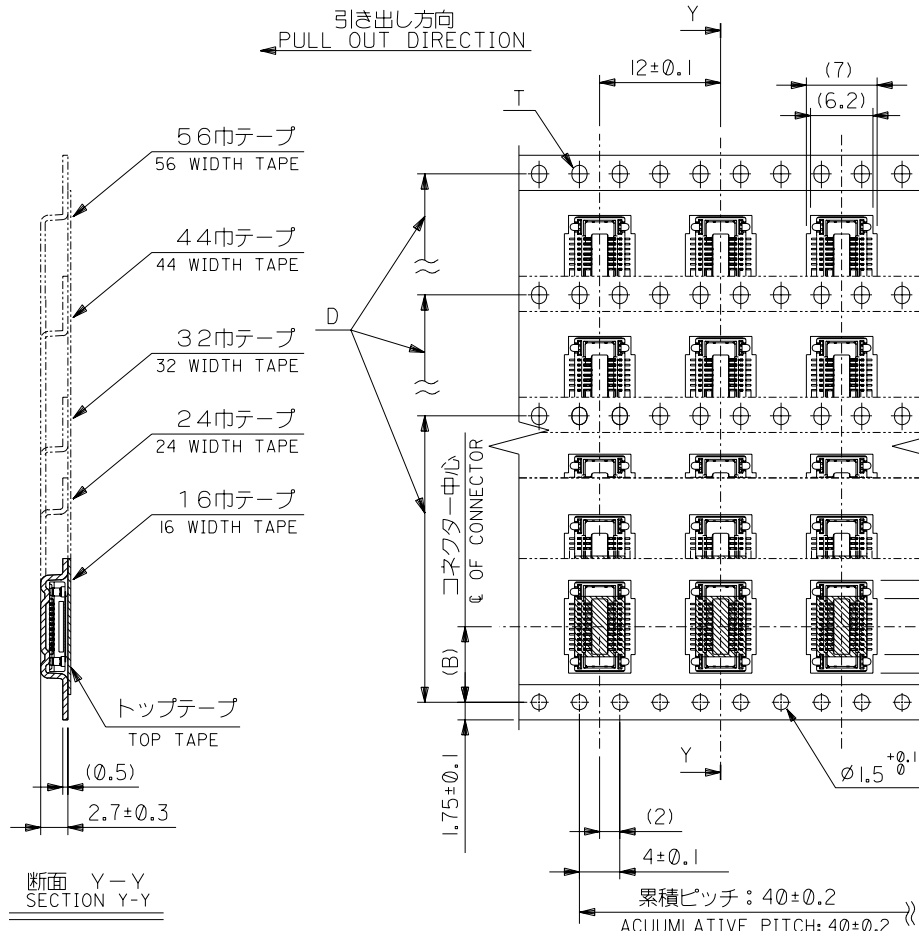

57.5	56±0.3	52.4	44.2	26.2	40.55	54363-1604	160	—
			39.2		35.55	54363-1404	140	○
			34.2		30.55	54363-1204	120	○
45.5	44±0.3	40.4	29.2	20.2	25.55	54363-1004	100	○
			26.7		20.55	54363-0804	80	—
			24.2		18.05	54363-0704	70	—
33.5	32±0.3	28.4	21.7	14.2	15.55	54363-0604	60	○
			19.2		13.05	54363-0504	50	○
25.5	24±0.3	—	16.7	11.5	10.55	54363-0404	40	○
			11.7		8.05	54363-0304	30	○ B
17.5	16±0.3	—	9.2	7.5	5.55	54363-0204	20	○
F	E キャリアテープ幅 CARRIER TAPE WIDTH	D	(C)	(B)	(A)	製品番号 MATERIAL NO.	極数 CIRCUITS	量産対応 AVAILABLE

DO NOT SCALE DRAWING

EC NO. DRWN: CHK: APPR:	EC NO. DRWN: CHK: APPR:	REVISED ECNNO. J2003-1812 DRWN:H.SHIMOYAMA '97/01/4 CHK:K.KASAHARA '97/01/4 APPR:T.YAMAGUCHI '97/01/4	REVISED ECNNO. J2002-1629 DRWN:H.SHIMOYAMA '97/01/11 CHK:K.KASAHARA '97/01/11 APPR:T.YAMAGUCHI '97/01/11	REVISED ECNNO. JD2001-1201 DRWN:H.SHIMOYAMA '97/03/08 CHK:M.SASAO '97/03/08 APPR:H.IKESUGI '97/03/08	DESCRIPTION	MATERIAL 材料	FINISH 仕上げ	WIRE RANGE 適用線径範囲	INS. RANGE 被覆外径
		G	F	E		—	—	—	—

GENERAL TOLERANCES: (UNLESS SPECIFIED) 一般公差	SCALE NONE	DESIGN UNITS <input checked="" type="checkbox"/> mm <input type="checkbox"/> INCH	THIRD ANGLE PROJECTION	<input type="checkbox"/> mm <input type="checkbox"/> INCH <input type="checkbox"/> mm <input checked="" type="checkbox"/> mm ONLY	SHT REV
10 UNDER 未滿	±0.2	DRAWN BY & DATE Shimoyama '97/11/21	TITLE: 54363-***2 TAPING PACKAGE		
10 OVER 以上	±0.25	CHECKED BY & DATE M. Sasao '97/11/21			
30 OVER 以上	±0.3	APPROVED BY & DATE Shimoyama '97/11/21			
ANGLE 角度	±3°	CAD FILENAME 54363005.S02	MOLEX MOLEX INCORPORATED	MATERIAL NO. SEE CHART	DRAWING NO. SD-54363-005
					SHEET NO. 2
					THIS DRAWING CONTAINS INFORMATION THAT IS PROPRIETARY TO MOLEX INCORPORATED AND SHOULD NOT BE USED WITHOUT WRITTEN PERMISSION.
					SIZE B