

Wire Wound Type Common Mode Filter

ACM3225F2RV-101T01-T

1. Features

1. High common mode impedance at high frequency effects excellent noise suppression performance.
2. ACM3225F2R series realizes small size and low profile 3.2x2.5x2.5 mm
3. 100% Lead(Pb) & Halogen-Free and RoHS compliant.
4. Compliant with OPEN Alliance 1000Base-T1 of Ethernet standard.
5. High reliability -Reliability tests comply with AEC-Q200
6. Operating temperature -40~+125°C (Including self - temperature rise)



2. Dimension

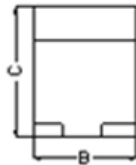
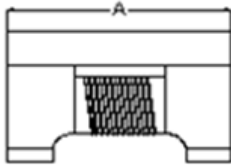

Recommended PC Board Pattern

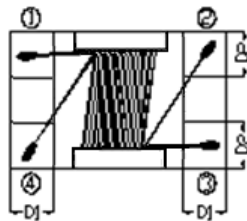
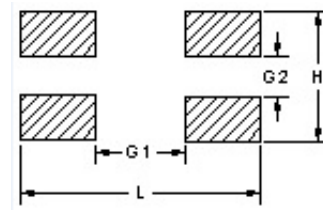

Series	A(mm)	B(mm)	C(mm)	D1(mm)	D2(mm)	L(mm)	H(mm)	G1(mm)	G2(mm)
3225F2R	3.3±0.2	2.5±0.2	2.5 max	0.55±0.15	1.00±0.20	3.7	2.8	2.4	0.6

Units: mm

3. Part Numbering

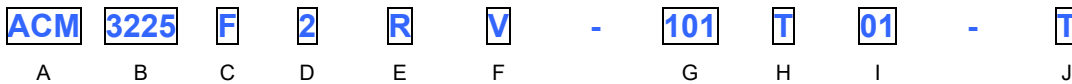

- A: Series
- B: Dimension
- C: Material Ferrite Core
- D: Number of Lines 2=2 lines
- E: Type JRC8G
- F: Category Code V=Vehicle
- G: Inductance 101=100(μH)
- H: Packaging T=Taping and Reel
- I: Rated Current 01=100mA
- J: Twist

4. Specification

TAI-TECH Part Number	Inductance (μH) [100KHz / 0.1V]		DC Resistance (Ω) ±20%	Rated Current (mA) max.	Rated voltage (Vdc) max.	IR (MΩ) min.
ACM3225F2RV-101T01-T	100.(typ.)	80+50%/-30%	2.60	100	80	10

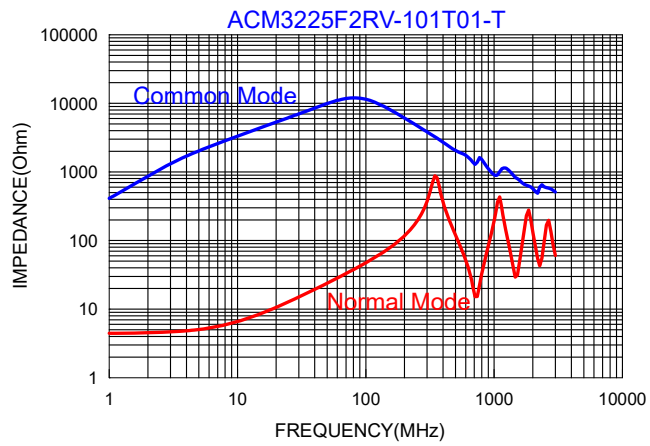

5. MEASURING CIRCUITS 2LINE

Common mode

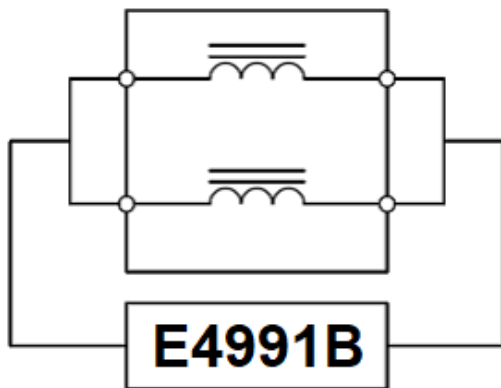

Differential mode

