

## Harvatek Surface Mount CHIP LEDs Data Sheet B36H3RGB-F6C0001HOU1930

Official Product	HT Part No. B36H3RGB-F6C0001HOU1930		
Tentative Product	*****	*****	*****
Specifications are subject to changes for improvement without advance notice. Proprietary data, drawings, company confidential all rights reserved.		28/07/2022	Version1.0 Page 1/17

<b>DISCLAIMER</b> .....	<b>3</b>
<b>LIFE SUPPORT POLICY</b> .....	<b>3</b>
<b>PRODUCT SPECIFICATIONS</b> .....	<b>4</b>
<b>ATTENTION: ELECTROSTATIC DISCHARGE (ESD) PROTECTION</b> .....	<b>4</b>
<b>LABEL SPECIFICATIONS</b> .....	<b>5</b>
<b>SPECIFICATIONS RANGE</b> .....	<b>6</b>
<b>PRODUCT FEATURES</b> .....	<b>6</b>
<b>ELECTRO-OPTICAL CHARACTERISTICS</b> .....	<b>7</b>
<b>PACKAGE OUTLINE DIMENSION AND RECOMMENDED SOLDERING PATTERN FOR REFLOW</b>	
<b>SOLDERING</b> .....	<b>7</b>
<b>CHARACTERISTICS OF B36H3RGB</b> .....	<b>9</b>
<b>PRECAUTION FOR USE</b> .....	<b>10</b>
<b>PACKAGING</b> .....	<b>11</b>
<b>TAPE DIMENSION</b> .....	<b>11</b>
<b>REEL DIMENSION</b> .....	<b>12</b>
<b>PACKING</b> .....	<b>12</b>
<b>DRY PACK</b> .....	<b>13</b>
<b>BAKING</b> .....	<b>13</b>
<b>PRECAUTIONS</b> .....	<b>13</b>
<b>HANDLING OF SILICONE RESIN LEDS</b> .....	<b>14</b>
<b>REFLOW SOLDERING</b> .....	<b>15</b>
<b>REWORKING</b> .....	<b>15</b>
<b>CLEANING</b> .....	<b>15</b>
<b>CAUTIONS OF PICK AND PLACE</b> .....	<b>16</b>
<b>REVISE HISTORY</b> .....	<b>16</b>

Official Product	HT Part No. B36H3RGB-F6C0001HOU1930		
Tentative Product	*****	*****	
Specifications are subject to changes for improvement without advance notice. Proprietary data, drawings, company confidential all rights reserved.		28/07/2022	Version1.0 Page 2/17

## DISCLAIMER

HARVATEK reserves the right to make changes without further notice to any products herein to improve reliability, function or design. HARVATEK does not assume any liability arising out of the application or use of any product or circuit described herein; neither does it convey any license under its patent rights, nor the rights of others.

## Life Support Policy

HARVATEK's products are not authorized for use as critical components in life support devices or systems without the express written approval of the President of HARVATEK or HARVATEK INTERNATIONAL. As used herein:

1. Life support devices or systems are devices or systems which, (a) are intended for surgical implant into the body, or (b) support or sustain life, and (c) whose failure to perform when properly used in accordance with instructions for use provided in the labeling, can be reasonably expected to result in a significant injury of the user.
2. A critical component in any component of a life support device or system whose failure to perform can be reasonably expected to cause the failure of the life support device or system, or to affect its safety or effectiveness.

Official Product	HT Part No. B36H3RGB-F6C0001HOU1930		
Tentative Product	*****	*****	*****
Specifications are subject to changes for improvement without advance notice. Proprietary data, drawings, company confidential all rights reserved.	28/07/2022	Version1.0	Page 3/17

## Product Specifications

Item	Specification	Material	Quantity
Luminous Intensity(Iv)	Red : 32 mcd typical Green : 46 mcd typical Blue : 8 mcd typical R@5mA;G/B@2mA/ Ts= 25° C; Tolerance ±10%		
Dominant Wavelength	Red : 621 nm typical Green : 530 nm typical Blue : 470 nm typical R@5mA;G/B@2mA/ Ts= 25° C;Tolerance ± 0.5nm		
Forward Voltage	Red : 2.4 V maximum Green : 3.1 V maximum Blue : 3.1 V maximum R@5mA;G/B@2mA/ Ts= 25° C;Tolerance ± 0.05V		
$I_r$	$< =1 \mu A @ V_R = 5 V$		
Resin	Dark	Epoxy	
Carrier tape	EIA 481-1A specs	Conductive black tape	24000pcs/reel
Reel	EIA 481-1A specs	Conductive black	
Label	HT standard	Paper	
Packing bag	250x230mm	Aluminum laminated bag/ no-zipper	One reel per bag
Carton	HT standard	Paper	Non-specified

Others:

Each immediate box consists of 28 reels. The 28 reels may not necessarily have the same lot number or the same bin combinations of  $I_v$ ,  $\lambda_D$  and  $V_f$ . Each reel has a label identifying its specification; the immediate box consists of a product label.

※Remarks: This product should be operated in forward bias. If a reverse voltage is continuously applied to the product, such operation can cause migration resulting in LED damage.

**ATTENTION: Electrostatic Discharge (ESD) protection**



The symbol to the left denotes that ESD precaution is needed. ESD protection for GaP and AlGaAs based chips is necessary even though they are relatively safe in the presence of low static-electric discharge. Parts built with AlGaInP, GaN, or/and InGaN based chips are **STATIC SENSITIVE devices**. ESD precaution must be taken during design and assembly.

If manual work or processing is needed, please ensure the device is adequately protected from ESD during the process.

Official Product	HT Part No. B36H3RGB-F6C0001HOU1930		
Tentative Product	*****	*****	
Specifications are subject to changes for improvement without advance notice. Proprietary data, drawings, company confidential all rights reserved.	28/07/2022	Version1.0	Page 4/17

## Label Specifications

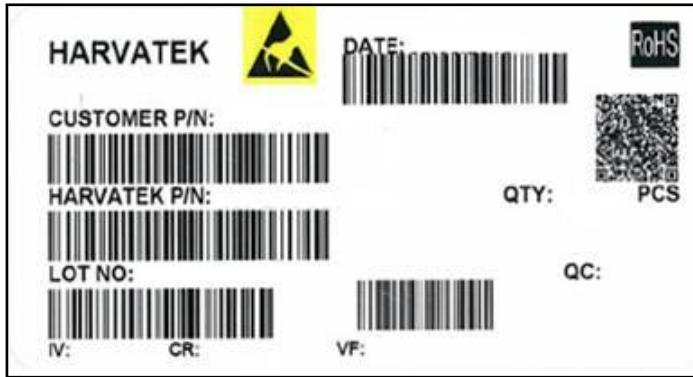

### Harvatek P/N:

**B            36H            3            RGB-            F6C-            0001            HO**

Product	Package size	Dice Qty	Color	Current	Series Number	Taping
PCB	0.69(L) x 0.69(W) x 0.5(H) mm	3 : Tri.	RGB(Full color)	R:5mA G:2mA B:2mA	X001~XZZZ	1.Taping style 2. Qty

### Lot No.:

1	2	3	4	5	6	7	8	9	10
E	1	A	1	A	2	2	L	1	2
Code 1 2		Code 3	Code 4	Code 5	Code 6	Code 7	Code 8	Code 9	Code 10
		Mfg. Year	Mfg. Month	Mfg. Date	Consecutive number		Special code		
Internal Tracing Code		2020-L 2021-M 2022-P 2023-Q ... 2026-T 2027-V ... 2030-Y 2031-Z ...	1:Jan. 2:Feb. ... A:Oct. B:Nov. C:Dec.	1:A 2:B 3:C ... 26:Z 27:7 28:8 29:9 30:3 31:4	01~ZZ		000~ZZZ		

Official Product	HT Part No. B36H3RGB-F6C0001HOU1930		
Tentative Product	*****	*****	*****
Specifications are subject to changes for improvement without advance notice. Proprietary data, drawings, company confidential all rights reserved.		28/07/2022	Version1.0      Page 5/17

## Specifications Range

### ■ Luminous Intensity (Iv) Bin:

Luminous Intensity (Iv) Bin: R@5mA;G/B @2mA

B36H3RGB Series								
IV								
Red			Green			Blue		
TE3	18	23.5	TF3	26.9	35	TB2	4.8	6.3
TF1	20.7	26.9	TG1	30.4	39.5	TB3	5.5	7.2
TF2	23.5	30.4	TG2	35	45.5	TC1	6.3	8.2
TF3	26.9	35	TG3	39.5	51.4	TC2	7.2	9.4
TG1	30.4	39.5	TH1	45.5	59.2	TC3	8.2	10.7
TG2	35	45.5	TH2	51.4	66.8	TD1	9.4	12.2

Note: It maintains a tolerance of ±10% on Luminous Intensity

### Dominant Wavelength (λ<sub>D</sub>) Bin: R@5mA;G/B @2mA

B36H3RGB Series								
WD								
Red			Green			Blue		
RT2	618	623	GT1	527	531	BT2	466	470
RT3	620	625	GT2	529	533	BT3	468	472
			GT3	531	535	BT4	470	474
			GT4	533	537	BT5	472	476
			GT5	535	539			

Note: It maintains a tolerance of ±0.5nm on Color Bin

### Forward Voltage (Vf) Bin: R@5mA;G/B @2mA

B36H3RGB Series								
Vf								
Red			Green			Blue		
E18	1.6	2.4	F2A	2.1	3.1	F2A	2.1	3.1

Note: It maintains a tolerance of ±0.05V on forward voltage measurements

Official Product	HT Part No. B36H3RGB-F6C0001HOU1930								
Tentative Product	*****			*****			*****		
Specifications are subject to changes for improvement without advance notice. Proprietary data, drawings, company confidential all rights reserved.						28/07/2022	Version1.0	Page 6/17	

Product Features

**Electro-Optical Characteristics**

(T<sub>Soldering</sub> 25 °C)

Code for parts	Lighting Color	Material	Forward Voltage (V)		Dominant Wavelength / Chromaticity Coordinate TYP. nm / CIE (X,Y)	Iv (mcd) Typ.	IF (mA)	Viewing Angle $2\theta\frac{1}{2}$
			typ.	Max				
B36H3RGB-F6	Red	AlGaNInP	1.9	2.4	621	32	5	120
B36H3RGB-F6	Green	InGaN	2.5	3.1	530	46	2	
B36H3RGB-F6	Blue	InGaN	2.5	3.1	469	8	2	

**Package Outline Dimension and Recommended Soldering Pattern for Reflow Soldering**

(Unit :mm Tolerance: +/-0.1)

Outline Dim.	Suggest Soldering Pattern
<p>Soldering terminals may shift in the x, y direction.</p>	

Official Product	HT Part No. B36H3RGB-F6C0001HOU1930		
Tentative Product	*****	*****	*****
Specifications are subject to changes for improvement without advance notice. Proprietary data, drawings, company confidential all rights reserved.	28/07/2022	Version1.0	Page 7/17

## Absolute Maximum Ratings(絕對最大額定值)

(T<sub>S</sub> 25 °C)

Series (系列)	P <sub>D</sub> (mW) (消耗功率)	I <sub>F</sub> (mA) (順向電流)	I <sub>FP</sub> (mA) (脈衝順向電流)	VR (反向電壓)	T <sub>OP</sub> (°C) (操作溫度)	T <sub>ST</sub> (°C) (儲存溫度)
Color	Power Dissipation	Forward Current	Pulse Forward Current	Reverse Voltage	Operation Temperature	Storage Temperature
Red/	24.4	5	20	5	-30~+80	-40~+85
Green		2				
Blue		2				

\*\* Condition for I<sub>FP</sub> is pulse of 1/10 duty and 0.1msec width

Remarks: This product should be operated in forward bias. If a reverse voltage is continuously applied to the product, such operation can cause migration resulting in LED damage.

Official Product	HT Part No. B36H3RGB-F6C0001HOU1930		
Tentative Product	*****	*****	*****
Specifications are subject to changes for improvement without advance notice. Proprietary data, drawings, company confidential all rights reserved.		28/07/2022	Version1.0 Page 8/17



## Characteristics of B36H3RGB

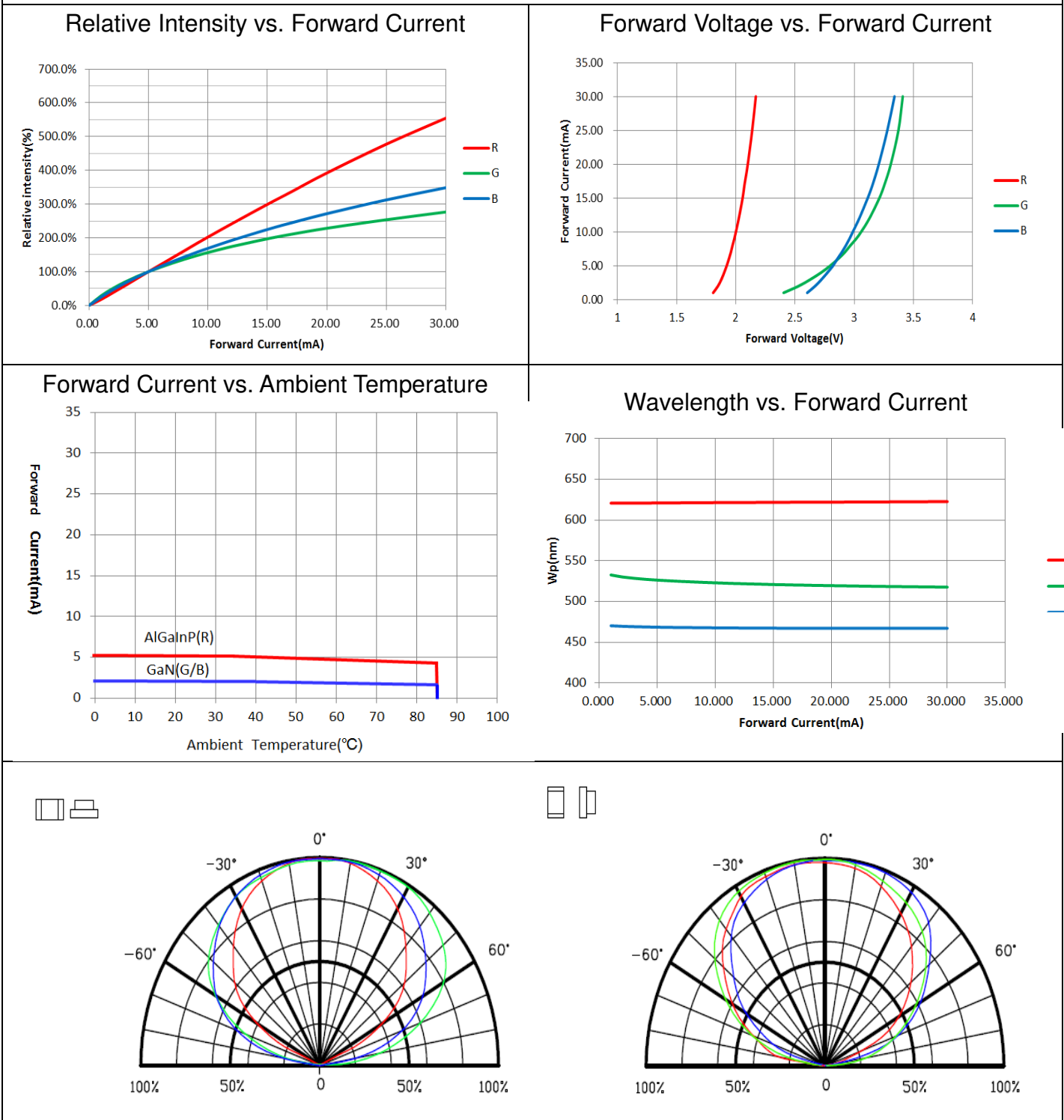

Official Product	HT Part No. B36H3RGB-F6C0001HOU1930		
Tentative Product	*****	*****	*****
Specifications are subject to changes for improvement without advance notice. Proprietary data, drawings, company confidential all rights reserved.	28/07/2022	Version1.0	Page 9/17

## Precaution for Use

1. The chips should not be used directly in any type of fluid such as water, oil, organic solvent, etc.
2. When the LEDs are illuminating, the maximum ambient temperature should be first considered before operation.
3. LEDs must be stored in a clean environment. A sealed container with a nitrogen atmosphere is necessary if the storage period is over 3 months after shipping.
4. The LEDs must be used within 4weeks after unpacked. Unused products must be repacked in an anti-electrostatic package, folded to close any opening and then stored in a dry and cool space.
5. The appearance and specifications of the products may be modified for improvement without further notice.
6. The LEDs are sensitive to the static electricity and surge. It is strongly recommended to use a grounded wrist band and anti-electrostatic glove when handling the LEDs. If a voltage over the absolute maximum rating is applied to LEDs, it will damage LEDs. Damaged LEDs will show some abnormal characteristics such as remarkable increase of leak current, lower turn-on voltage and getting unlit at low current.

Official Product	HT Part No. B36H3RGB-F6C0001HOU1930		
Tentative Product	*****	*****	*****
Specifications are subject to changes for improvement without advance notice. Proprietary data, drawings, company confidential all rights reserved.		28/07/2022	Version1.0 Page 10/17

## Packaging Tape Dimension

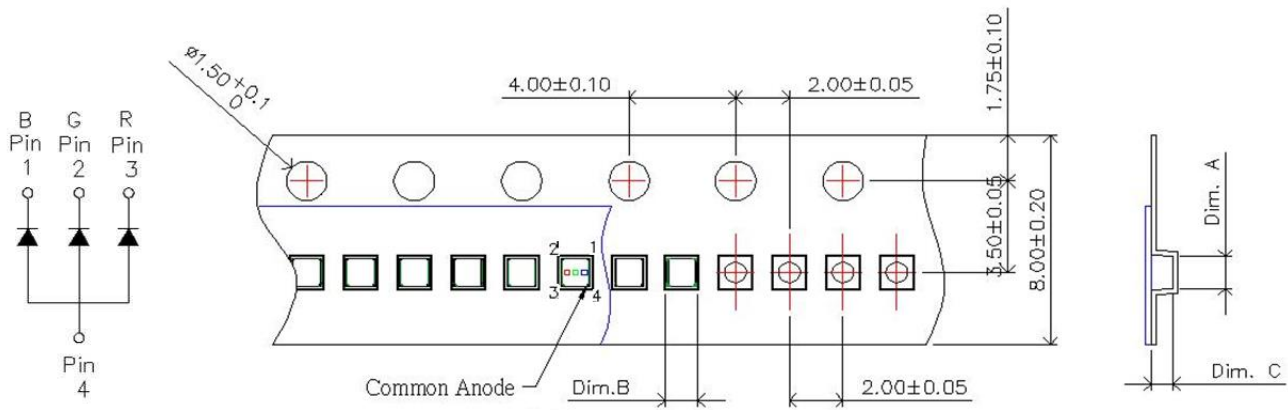

Dim. A	Dim. B	Dim. C	Qty/Reel
$0.78 \pm 0.05$	$0.78 \pm 0.05$	$0.55 \pm 0.05$	24K

Unit: mm

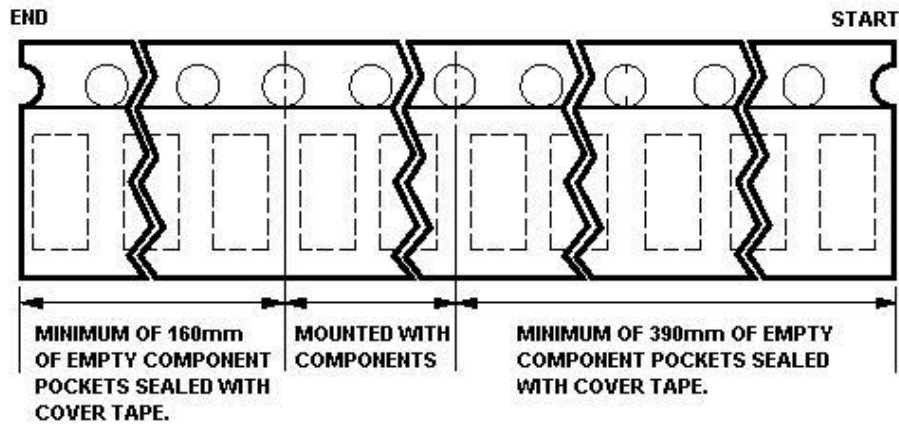

Official Product	HT Part No. B36H3RGB-F6C0001HOU1930		
Tentative Product	*****	*****	*****
Specifications are subject to changes for improvement without advance notice. Proprietary data, drawings, company confidential all rights reserved.	28/07/2022	Version1.0	Page 11/17

## Reel Dimension

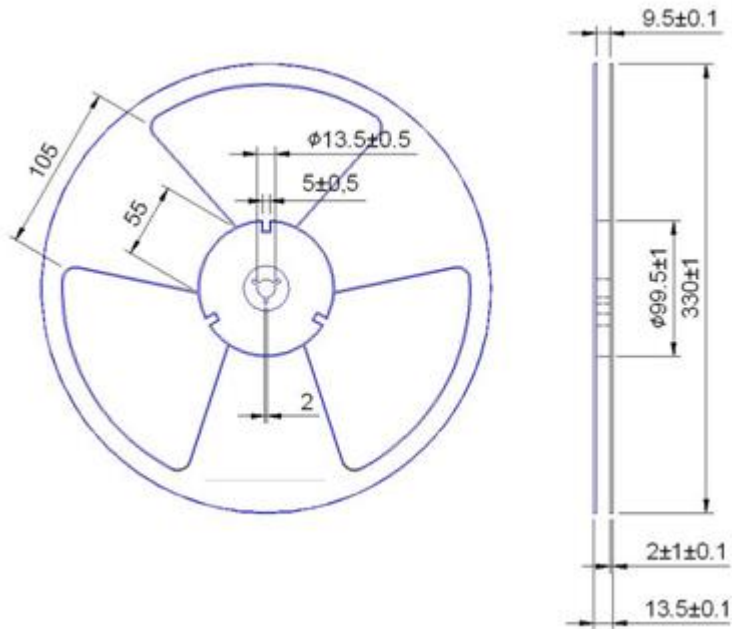

## Packing

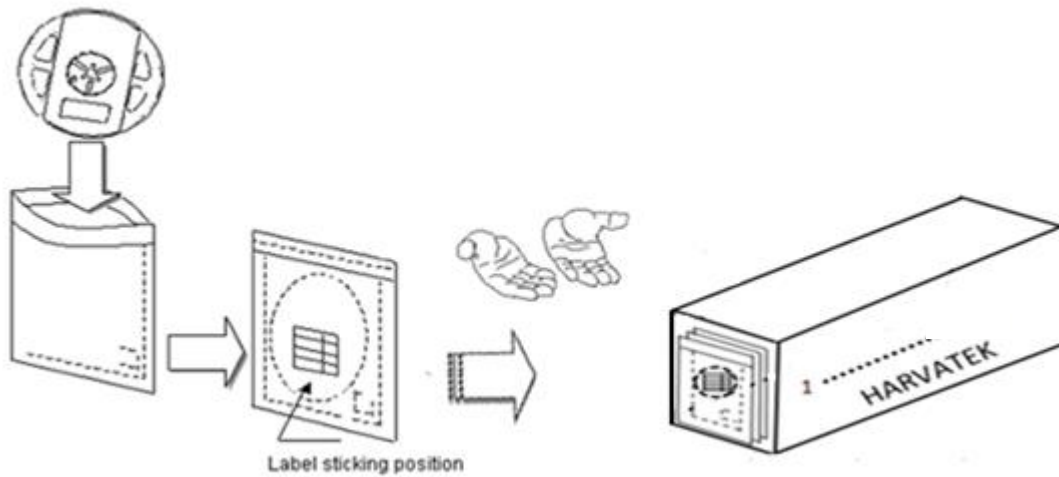

28 boxes per carton is available depending on shipment quantity.

Official Product	HT Part No. B36H3RGB-F6C0001HOU1930		
Tentative Product	*****	*****	*****
Specifications are subject to changes for improvement without advance notice. Proprietary data, drawings, company confidential all rights reserved.		28/07/2022	Version1.0 Page 12/17

## Dry Pack

All SMD optical devices are **MOISTURE SENSITIVE**. Avoid exposure to moisture at all times during transportation or storage. Every reel is packaged in a moisture protected anti-static bag. Each bag is properly sealed prior to shipment.

A humidity indicator will be included in the moisture protected anti-static bag prior to shipment.

The packaging sequence is as follows:

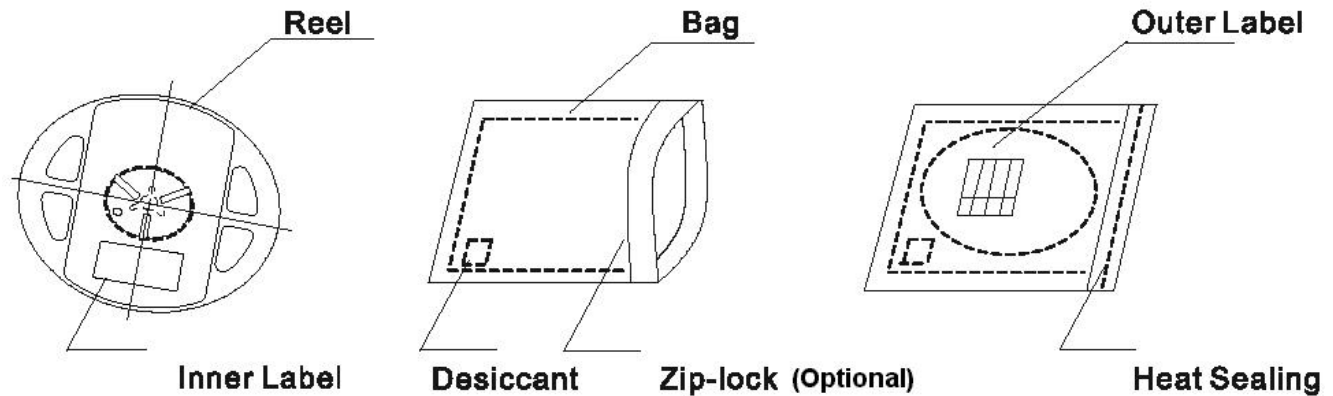

## Baking

Baking before soldering is recommended when the package has been unsealed for 4weeks.

The conditions are as followings:

1. MBB open ≤ 672hrs, 50±3°C × (3hrs).
2. MBB open > 672hrs, 50±3°C × (8~12hrs) and < 5%RH, taped reel type.
3. 100±3°C × (45min~1hr), bulk type.
4. 130±3°C × (15min~30min), bulk type.

## Precautions

1. Avoid exposure to moisture at all times during transportation or storage.
2. Anti-Static precaution must be taken when handling GaN, InGaN, and AlGaInP products.
3. It is suggested to connect the unit with a current limiting resistor of the proper size. Avoid applying a reverse voltage beyond the specified limit.
4. Avoid operation beyond the limits as specified by the absolute maximum ratings.
5. Avoid direct contact with the surface through which the LED emits light.
6. If possible, assemble the unit in a clean room or dust-free environment.

Official Product	HT Part No. B36H3RGB-F6C0001HOU1930		
Tentative Product	*****	*****	*****
Specifications are subject to changes for improvement without advance notice. Proprietary data, drawings, company confidential all rights reserved.		28/07/2022	Version1.0 Page 13/17

**Handling of Silicone Resin LEDs**

Handling Indications

During processing, mechanical stress on the surface should be minimized as much as possible.

Sharp objects of all types should not be used to pierce the sealing compound.



Figure 1

In general, LEDs should only be handled from the side. By the way, this also applies to LEDs without a silicone sealant, since the surface can also become scratched.

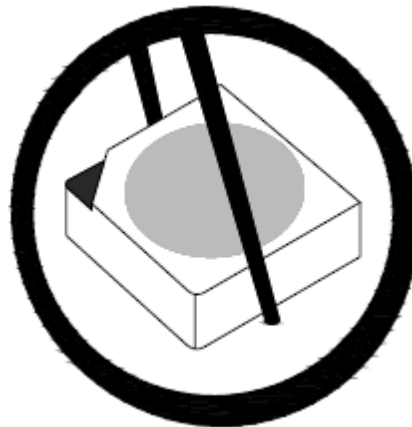

Figure 2

When populating boards in SMT production, there are basically no restrictions regarding the form of the pick and place nozzle, except that mechanical pressure on the surface of the resin must be prevented.

This is assured by choosing a pick and place nozzle which is large than LEDs reflector area.

Official Product	HT Part No. B36H3RGB-F6C0001HOU1930		
Tentative Product	*****	*****	*****
Specifications are subject to changes for improvement without advance notice. Proprietary data, drawings, company confidential all rights reserved.		28/07/2022	Version1.0 Page 14/17

**Reflow Soldering**

Recommend soldering paste specifications:

1. Operating temp.: Above 217 °C ,60~150 sec.
2. Peak temp.:260 °CMax.,10sec Max.
3. Reflow soldering should not be done more than two times.
4. Never attempt next process until the component is cooled down to room temperature after reflow.
5. The recommended reflow soldering profile (measured on the surface of the LED terminal) is as following:

Lead-free Solder Profile

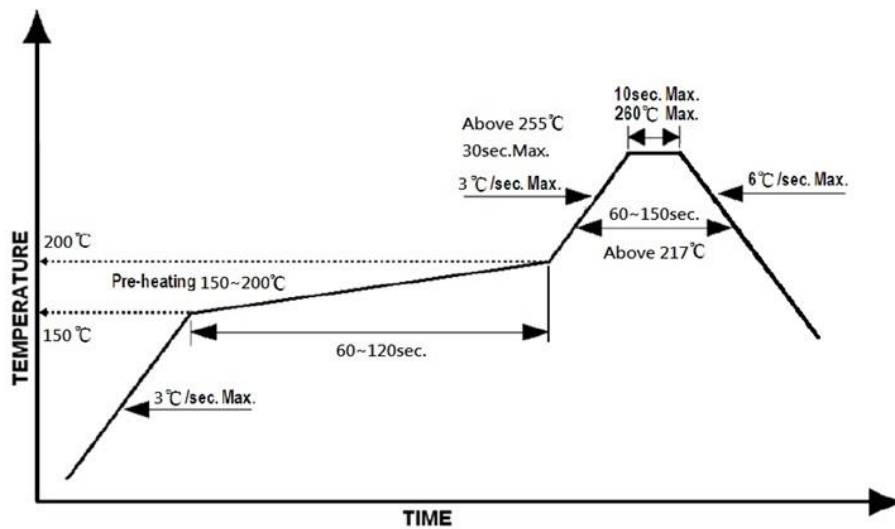

**Reworking**

- Rework should be completed within 5 seconds under 260 °C.
- The iron tip must not come in contact with the copper foil.
- Twin-head type is preferred.

**Cleaning**

Following are cleaning procedures after soldering:

- An alcohol-based solvent such as isopropyl alcohol (IPA) is recommended.
- Temperature x Time should be 50°C x 30sec. or <30°C x 3min
- Ultrasonic cleaning: < 15W/ bath; bath volume ≤ 1liter
- Curing: 100 °C max, <3min

Official Product	HT Part No. B36H3RGB-F6C0001HOU1930		
Tentative Product	*****	*****	*****
Specifications are subject to changes for improvement without advance notice. Proprietary data, drawings, company confidential all rights reserved.		28/07/2022	Version1.0 Page 15/17

### Cautions of Pick and Place

- Avoid stress on the resin at elevated temperature.
- Avoid rubbing or scraping the resin by any object.
- Electric-static may cause damage to the component. Please ensure that the equipment is properly grounded. Use of an ionizer fan is recommended.

### Revise History

Rev.	Descriptions	Date	Page
-	-	28/07/2022	-

Official Product	HT Part No. B36H3RGB-F6C0001HOU1930		
Tentative Product	*****	*****	
Specifications are subject to changes for improvement without advance notice. Proprietary data, drawings, company confidential all rights reserved.	28/07/2022	Version1.0	Page 16/17