

IA series

Low profile pushbutton switches for harsh environments • bushing Ø 16 mm • momentary



DISTINCTIVE FEATURES

Resistant to frost, sand and hydrocarbons

Tactile feedback

Front panel sealed to IP65 and IP67



ENVIRONMENTAL SPECIFICATIONS

- Front panel sealing :
IP65 and IP67 acc. to IEC 60529
- Salt spray : IEC 512-6, test 11f
- Operating temperature : -20 °C to +65 °C (-4 °F to +149 °F)



ELECTRICAL SPECIFICATIONS

- Max. current/voltage rating with resistive load : 2 A 24 VDC
- Initial contact resistance : 100 mΩ max.
- Insulation resistance : 100 MΩ min. at 500 VDC
- Dielectric strength : 500 Vrms
- Electrical life at full load : 1,000,000 cycles



GENERAL SPECIFICATIONS

- Panel thickness : 7 mm (.276) max.
- Total travel : 1.5 mm (.059) ± 0.3 mm
- Typical operating force : 7 N ± 2 N
- Low level or mechanical life : 1,000,000 cycles
- Torque : 0.5 to 1 Nm max. applied to nut



MATERIALS

- Case/bushing : thermoplastic
- Actuator : polyurethane
- Contacts : silver, gold plated
- Multi-wire leads AWG20, section 0.6 mm².
- Terminal seal : epoxy

The company reserves the right to change specifications without notice.



IA series

Low profile pushbutton switches for harsh environments • bushing Ø 16 mm • momentary



PANEL MOUNTING

- Panel cut-out Ø 16.2 mm (.637)
- Min. pitch for matrix mounting :
 - with standard hex nut : 27 x 27 mm (1.062 x 1.062)
 - with knurled nut U3327: 20 x 20 mm (.787x.787)

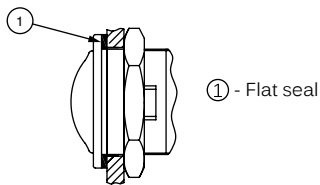

ELECTRICAL FUNCTIONS

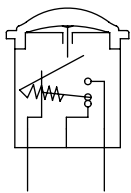

Function 3 (NO)

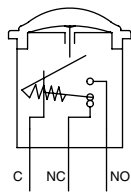

Function 5 (NC+NO)

IA series

Low profile pushbutton switches for harsh environments • bushing Ø 16 mm • momentary



BUILD YOUR PART NUMBER

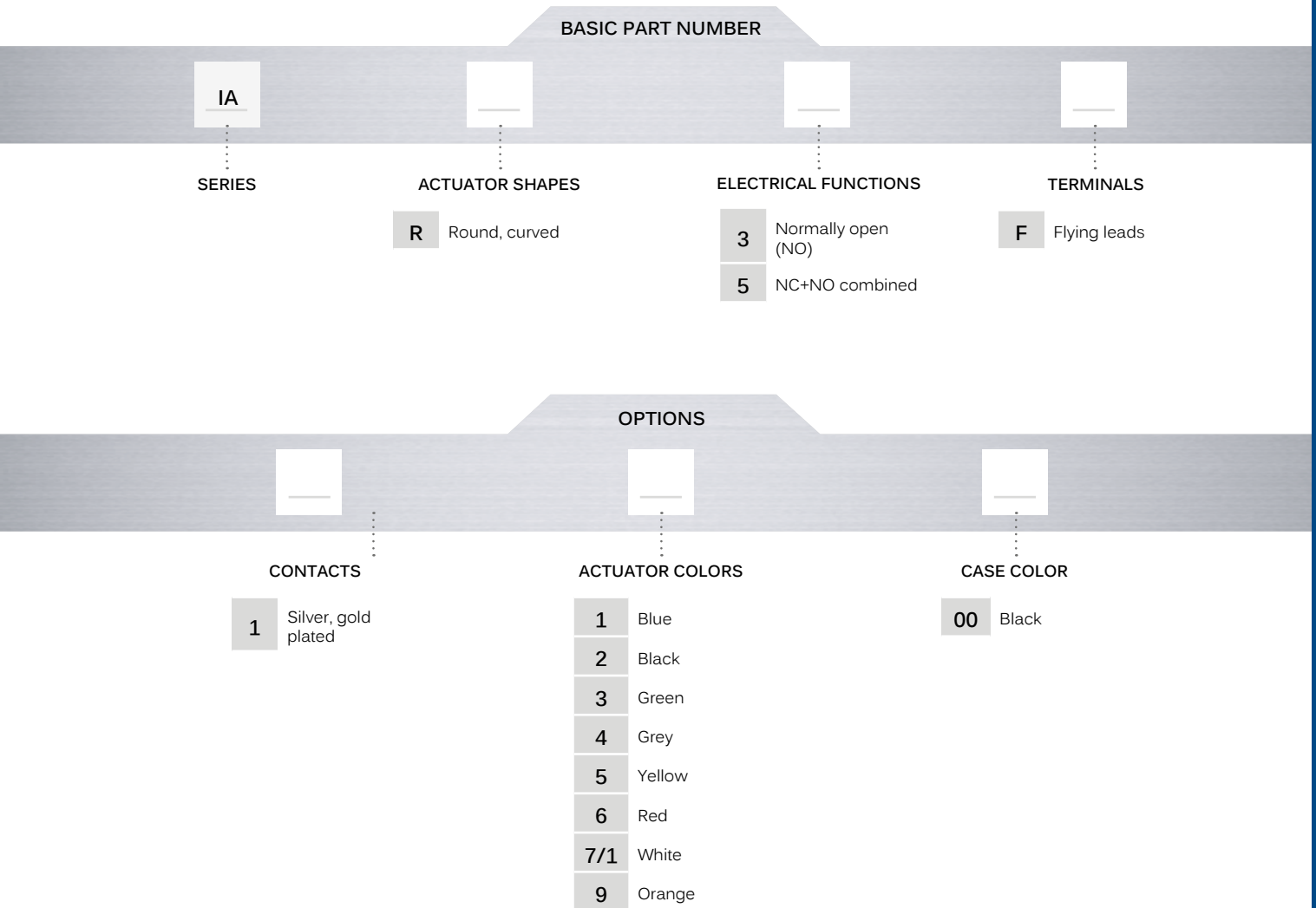

ABOUT THIS SERIES

On the following pages, you will find successively basic part numbers of switches and options in the same order as in above chart.



A **sealing boot** is available to protect the switches against frost and sand. See "Sealing Boots" section of website.



Mounting accessories : Standard hardware supplied : 1 hex nut 19 mm (.748) across flats and 1 flat seal. Knurled nut U3327 available on request.

IA series

Low profile pushbutton switches for harsh environments • bushing Ø 16 mm • momentary

MODELS

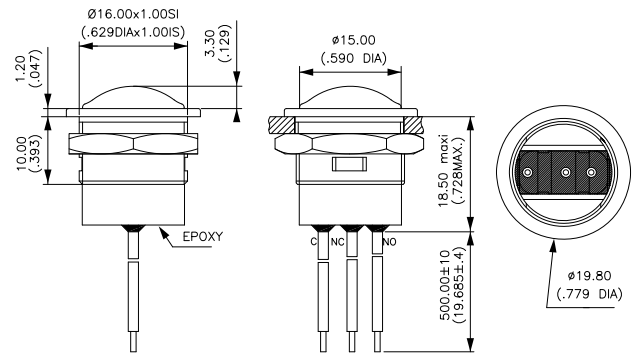
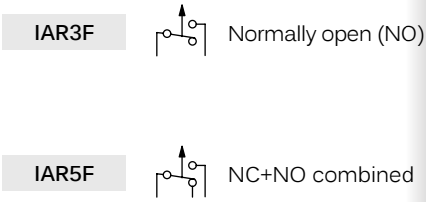

Wire colors (NC+NO) : black = common, brown = NC, blue = NO
NO model has 2 terminals only.

CONTACT MATERIAL



- 1 Silver, gold plated

ACTUATOR COLORS



- 1 Blue
- 2 Black
- 3 Green
- 4 Grey
- 5 Yellow
- 6 Red
- 7/1 White
- 9 Orange

CASE COLORS

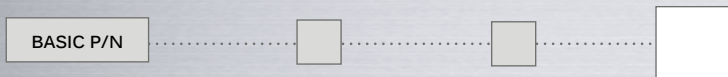

- 00 Black