

## 4.8A $I_{SW}$ , Synchronous Boost Regulator with Bi-Directional Load Disconnect

### Features

- Up to 95% Efficiency
- Input Voltage Range from 2.5V to 5.5V
- Fully Integrated, High-Efficiency, 2 MHz Synchronous Boost Regulator
- Bi-Directional True Load Disconnect
- Integrated Anti-Ringing Switch
- <1  $\mu$ A Shutdown Current
- Bypass Mode for  $V_{IN} \geq V_{OUT}$
- Overcurrent Protection and Thermal Shutdown
- Fixed and Adjustable Output Versions
- 8-pin 2 mm  $\times$  2 mm UDFN package

### Applications

- Tablets and Smartphones
- USB OTG and HDMI Hosts
- Portable Power Reserve Supplies
- High-Current Parallel Lithium Cell Applications
- Portable Equipment

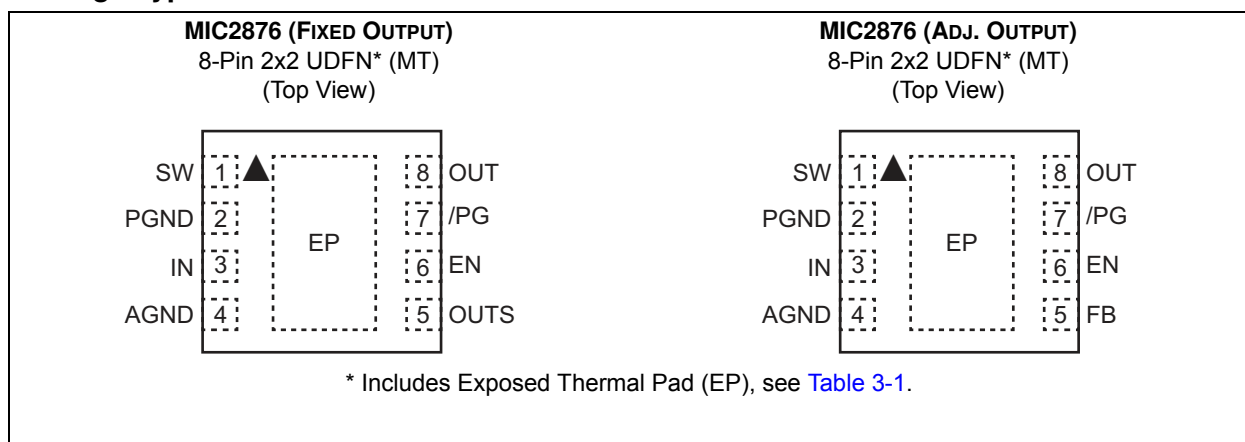
### General Description

The MIC2876 is a compact and highly efficient 2 MHz synchronous boost regulator with a 4.8A switch. It features a bi-directional load disconnect function that prevents any leakage current between the input and output when the device is disabled. The MIC2876 operates in bypass mode automatically when the input voltage is greater than the target output voltage. At light loads, the boost converter goes to the PFM mode to improve the efficiency.

The MIC2876 also features an integrated anti-ringing switch to minimize EMI.

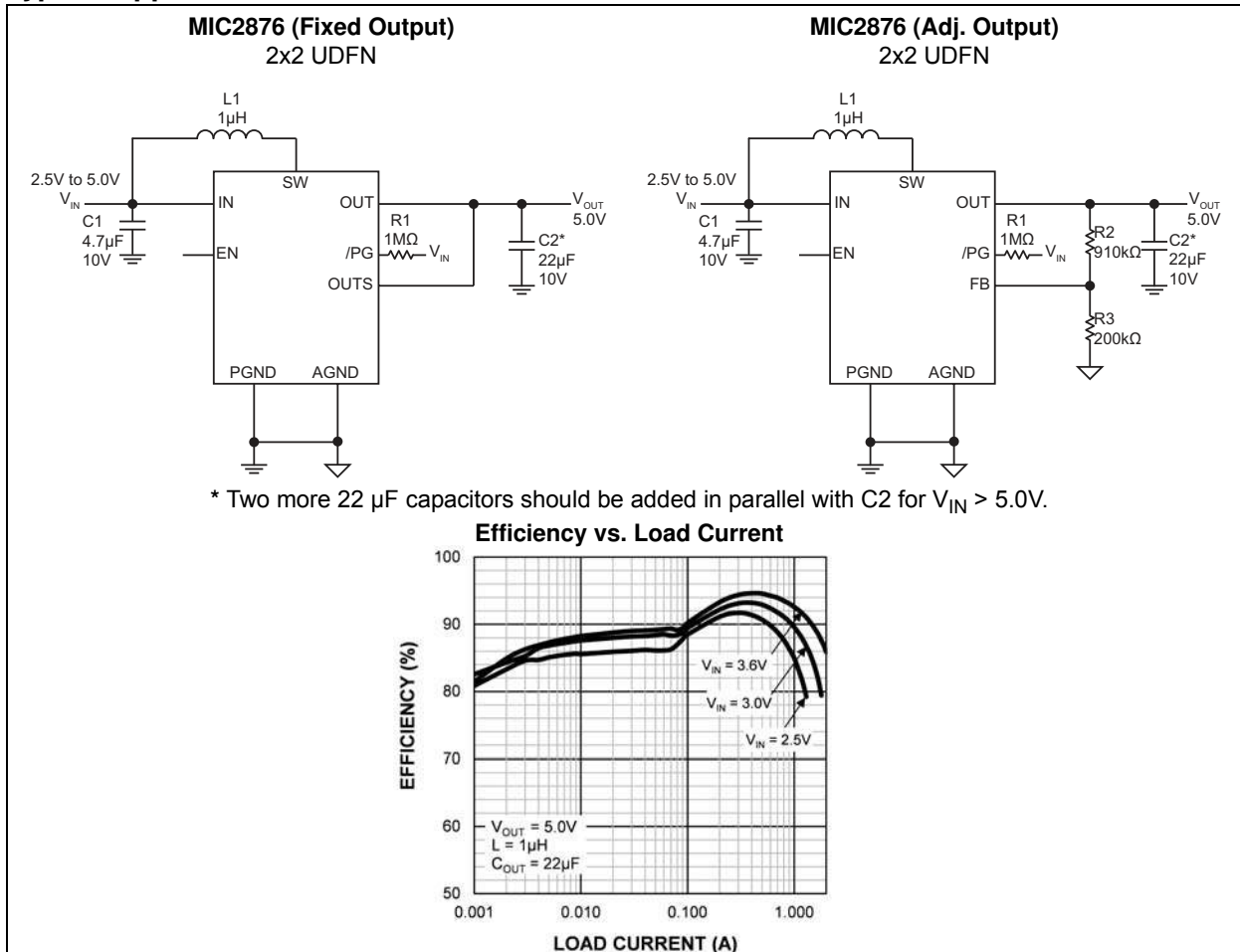
The MIC2876 is available in a 8-pin 2 mm  $\times$  2 mm UDFN package, with a junction temperature range of  $-40^{\circ}\text{C}$  to  $+125^{\circ}\text{C}$ .

### Package Types

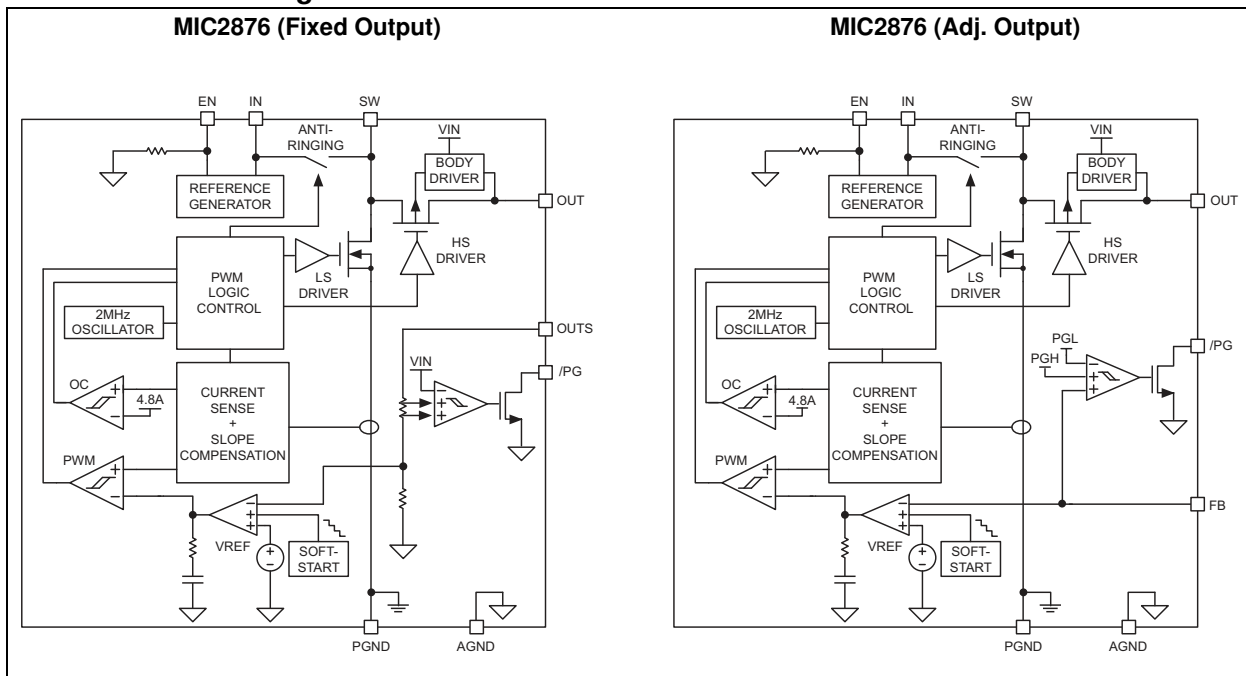


# MIC2876

## Typical Application Schematics



## Functional Block Diagrams



## 1.0 ELECTRICAL CHARACTERISTICS

### Absolute Maximum Ratings †

IN, EN, OUT, FB, /PG to PGND .....	-0.3V to +6V
AGND to PGND .....	-0.3V to +0.3V
ESD Rating (HBM) (Note 1).....	1.5 kV
ESD Rating (MM) (Note 1).....	200V
Power Dissipation (Note 2) .....	Internally Limited

### Operating Ratings ‡

Supply Voltage ( $V_{IN}$ ) .....	+2.5V to +5.5V
Output Voltage ( $V_{OUT}$ ) .....	Up to +5.5V
Enable Voltage ( $V_{EN}$ ).....	0V to $V_{IN}$

† **Notice:** Stresses above those listed under “Absolute Maximum Ratings” may cause permanent damage to the device. This is a stress rating only and functional operation of the device at those or any other conditions above those indicated in the operational sections of this specification is not intended. Exposure to maximum rating conditions for extended periods may affect device reliability.

‡ **Notice:** The device is not guaranteed to function outside its operating ratings.

**Note 1:** Devices are ESD sensitive. Handling precautions are recommended. Human body model, 1.5 k $\Omega$  in series with 100 pF.

**2:** The maximum allowable power dissipation of any  $T_A$  (ambient temperature) is  $P_{D(max)} = (T_{J(max)} - T_A) / \theta_{JA}$ . Exceeding the maximum allowable power dissipation will result in excessive die temperature, and the regulator will go into thermal shutdown.

# MIC2876

**TABLE 1-1: ELECTRICAL CHARACTERISTICS**

<b>Electrical Characteristics:</b> $V_{IN} = 3.6V$ , $V_{OUT} = 5V$ , $C_{IN} = 4.7 \mu F$ , $C_{OUT} = 22 \mu F$ , $L = 1 \mu H$ , $T_A = 25^\circ C$ , unless noted. <b>Bold</b> values are valid for $-40^\circ C \leq T_J \leq +125^\circ C$ . ( <b>Note 1</b> ).						
Parameters	Sym.	Min.	Typ.	Max.	Units	Conditions
<b>Power Supply</b>						
Supply Voltage Range	$V_{IN}$	<b>2.5</b>	—	<b>5.5</b>	V	—
UVLO Rising Threshold	$V_{UVLOR}$	—	2.32	<b>2.49</b>	V	—
UVLO Hysteresis	$V_{UVLOH}$	—	200	—	mV	—
Quiescent Current	$I_{VIN}$	—	109	—	$\mu A$	Non-switching
$V_{IN}$ Shutdown Current	$I_{VINSD}$	—	1	<b>3</b>	$\mu A$	$V_{EN} = 0V$ , $V_{IN} = 5.5V$ , $V_{OUT} = 0V$
$V_{OUT}$ Shutdown Current	$I_{VOUTSD}$	—	2	<b>5</b>	$\mu A$	$V_{EN} = 0V$ , $V_{IN} = 0.3V$ , $V_{OUT} = 5.5V$
Output Voltage	$V_{OUT}$	$V_{IN}$	—	5.5	V	—
Feedback Voltage	$V_{FB}$	<b>0.8865</b>	0.9	<b>0.9135</b>	V	Adjustable version, $I_{OUT} = 0A$
Voltage Accuracy	—	<b>-1.5</b>	—	<b>+1.5</b>	%	Fixed version, $I_{OUT} = 0A$
Line Regulation	—	—	0.3	—	%/V	$2.5V < V_{IN} < 4.5V$ , $I_{OUT} = 500 mA$
Load Regulation	—	—	0.2	—	%/A	$I_{OUT} = 200 mA$ to $1200 mA$
Maximum Duty Cycle	$D_{MAX}$	—	92	—	%	—
Minimum Duty Cycle	$D_{MIN}$	—	6.5	—	%	—
Low-Side Switch Current Limit ( <b>Note 2</b> )	$I_{LS}$	<b>3.8</b>	4.8	<b>5.8</b>	A	$V_{IN} = 2.5V$
Switch On-Resistance	PMOS	—	79	—	$m\Omega$	$V_{IN} = 3.0V$ , $I_{SW} = 200 mA$ , $V_{OUT} = 5.0V$
	NMOS	—	82	—		$V_{IN} = 3.0V$ , $I_{SW} = 200 mA$ , $V_{OUT} = 5.0V$
Switch Leakage Current	$I_{SW}$	—	0.2	<b>5</b>	$\mu A$	$V_{EN} = 0V$ , $V_{IN} = 5.5V$
Oscillator Frequency	$F_{OSC}$	<b>1.6</b>	2	<b>2.4</b>	MHz	—
Overtemperature Shutdown Threshold	$T_{SD}$	—	155	—	$^\circ C$	—
Overtemperature Shutdown Hysteresis	—	—	15	—	$^\circ C$	—
<b>Soft-Start</b>						
Soft-Start Time	$T_{SS}$	—	1.1	—	ms	$V_{OUT} = 5.0V$
<b>EN, /PG Control Pins</b>						
EN Threshold Voltage	$V_{EN}$	<b>1.5</b>	—	—	V	Boost converter and chip logic ON
		—	—	<b>0.4</b>		Boost converter and chip logic OFF
EN Pin Current	—	—	1.5	<b>3</b>	$\mu A$	$V_{IN} = V_{EN} = 3.6V$
Power Good Threshold (Rising)	$V_{/PG-THR}$	—	$0.9 \times V_{OUT}$	—	V	—

**Note 1:** Specification for packaged product only.

**2:** Guaranteed by design and characterization.

**TABLE 1-1: ELECTRICAL CHARACTERISTICS (CONTINUED)**

**Electrical Characteristics:**  $V_{IN} = 3.6V$ ,  $V_{OUT} = 5V$ ,  $C_{IN} = 4.7 \mu F$ ,  $C_{OUT} = 22 \mu F$ ,  $L = 1 \mu H$ ,  $T_A = 25^\circ C$ , unless noted. **Bold** values are valid for  $-40^\circ C \leq T_J \leq +125^\circ C$ . (**Note 1**).

Parameters	Sym.	Min.	Typ.	Max.	Units	Conditions
Power Good Threshold (Falling)	$V_{PG-THF}$	—	$0.83 \times V_{OUT}$	—	V	—

- Note 1:** Specification for packaged product only.  
**2:** Guaranteed by design and characterization.

# MIC2876

---

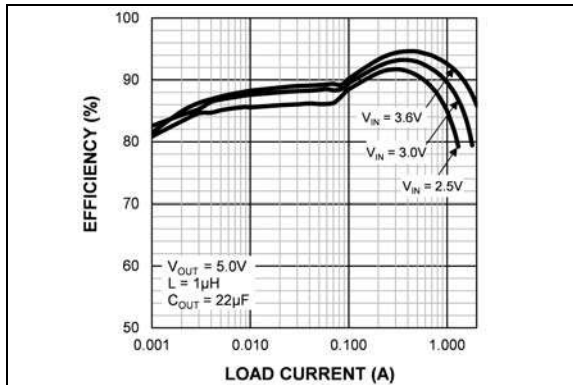
## TEMPERATURE SPECIFICATIONS

Parameters	Sym.	Min.	Typ.	Max.	Units	Conditions
<b>Temperature Ranges</b>						
Junction Operating Temperature	$T_J$	-40	—	+125	°C	<a href="#">Note 1</a>
Storage Temperature Range	$T_S$	-65	—	+150	°C	—
Lead Temperature	—	—	—	+260	°C	Soldering, 10s
<b>Package Thermal Resistances</b>						
Thermal Resistance, UDFN-22-8Ld	$\theta_{JA}$	—	90	—	°C/W	—

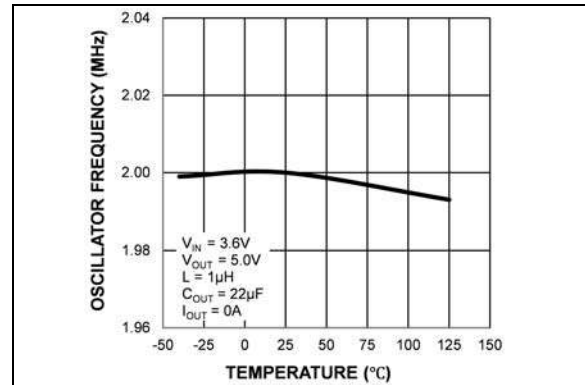
**Note 1:** The maximum allowable power dissipation is a function of ambient temperature, the maximum allowable junction temperature and the thermal resistance from junction to air (i.e.,  $T_A$ ,  $T_J$ ,  $\theta_{JA}$ ). Exceeding the maximum allowable power dissipation will cause the device operating junction temperature to exceed the maximum +125°C rating. Sustained junction temperatures above +125°C can impact the device reliability.

## 2.0 TYPICAL PERFORMANCE CURVES

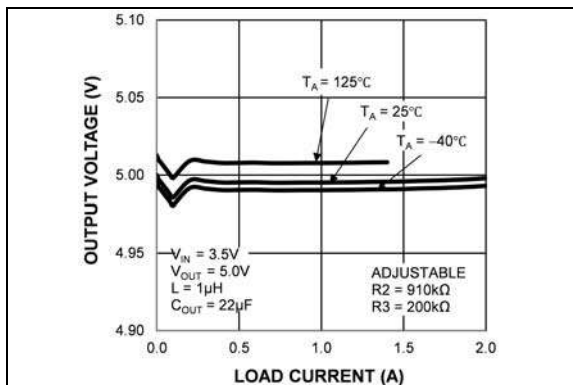
**Note:** The graphs and tables provided following this note are a statistical summary based on a limited number of samples and are provided for informational purposes only. The performance characteristics listed herein are not tested or guaranteed. In some graphs or tables, the data presented may be outside the specified operating range (e.g., outside specified power supply range) and therefore outside the warranted range.



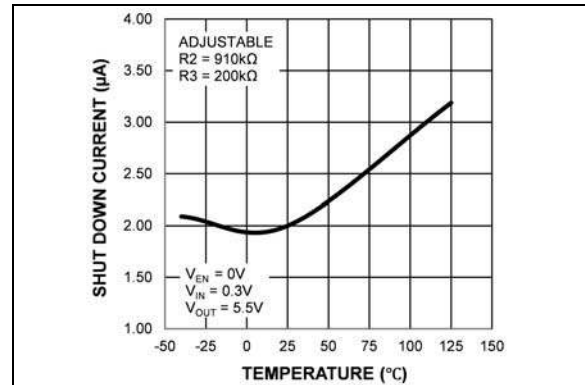
**FIGURE 2-1:** Efficiency vs. Load Current.



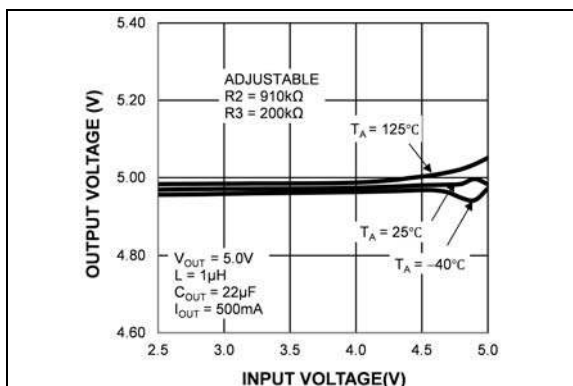
**FIGURE 2-4:** Oscillator Frequency vs. Temperature.



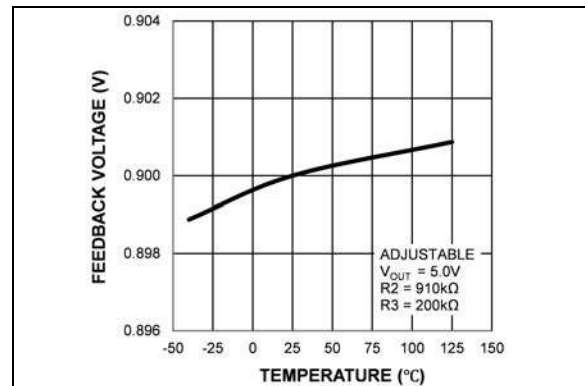
**FIGURE 2-2:** Output Voltage vs. Load Current.



**FIGURE 2-5:** Output Shutdown Current vs. Temperature.

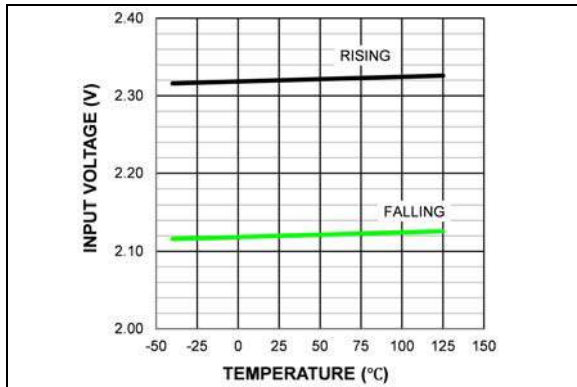


**FIGURE 2-3:** Output Voltage vs. Input Voltage.

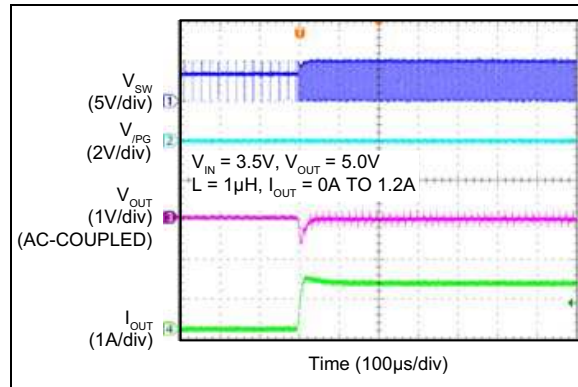


**FIGURE 2-6:** Feedback Voltage vs. Temperature.

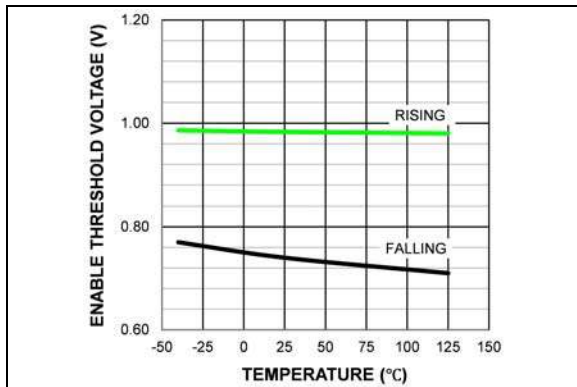
# MIC2876



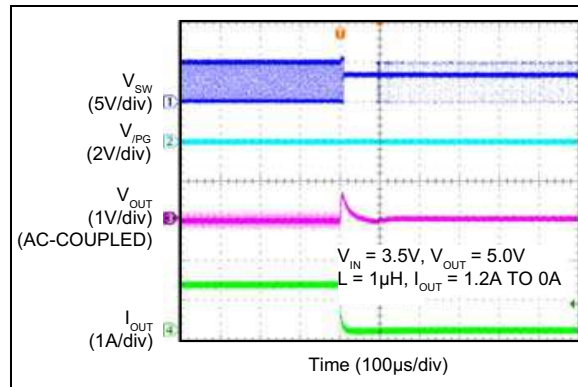
**FIGURE 2-7:** UVLO Threshold vs. Temperature.



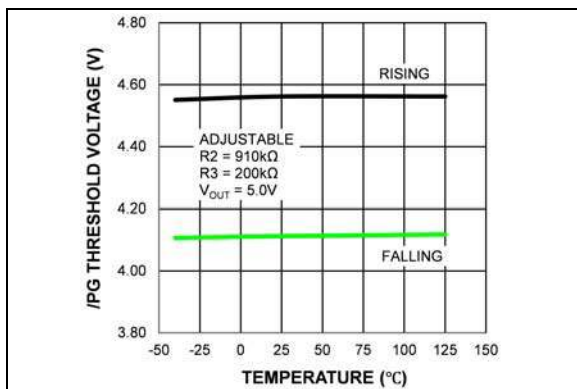
**FIGURE 2-10:** Load Transient (0A to 1.2A).



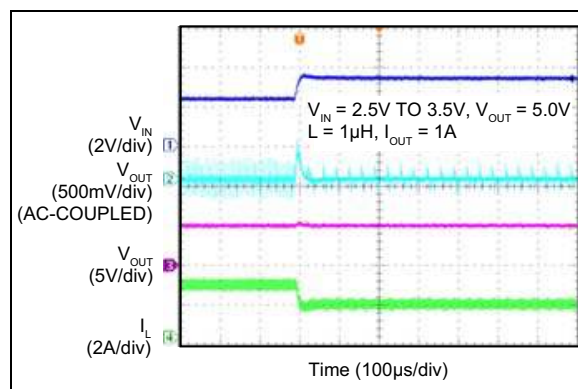
**FIGURE 2-8:** Enable Threshold vs. Temperature.



**FIGURE 2-11:** Load Transient (1.2A to 0A).

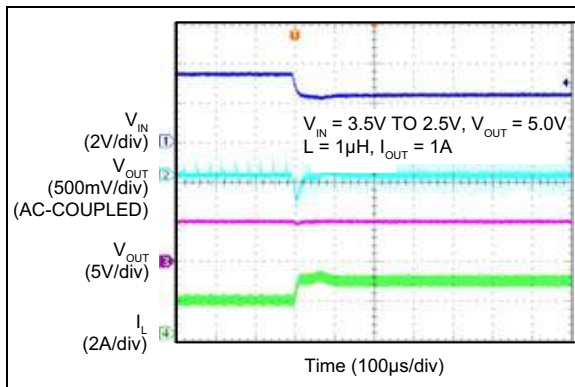


**FIGURE 2-9:** Power Good Threshold vs. Temperature.

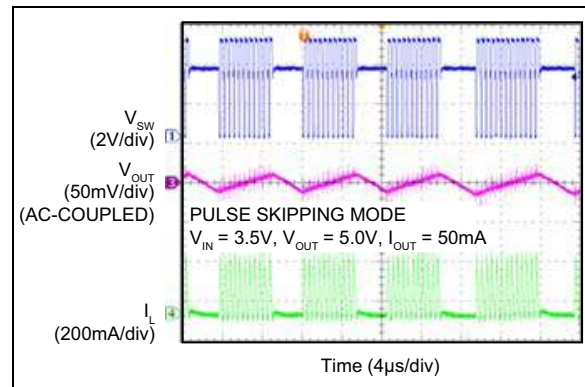


**FIGURE 2-12:** Line Transient (2.5V to 3.5V).

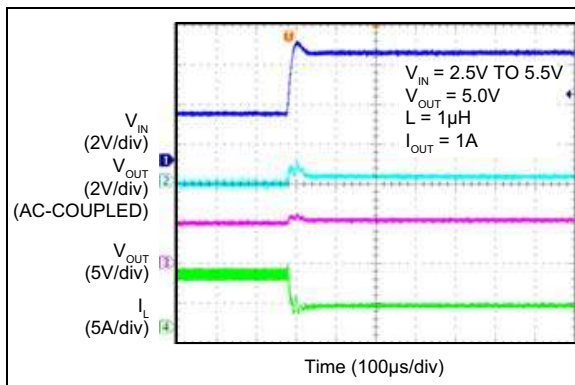




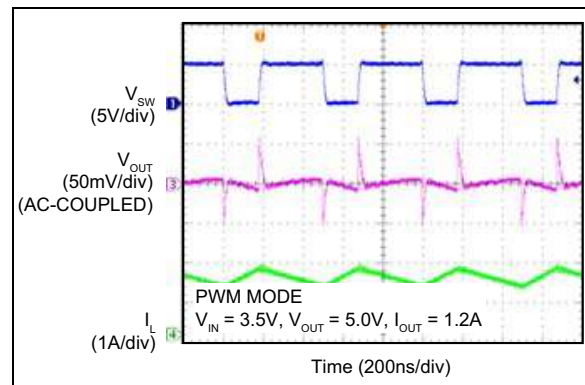
**FIGURE 2-13:** Line Transient (3.5V to 2.5V).



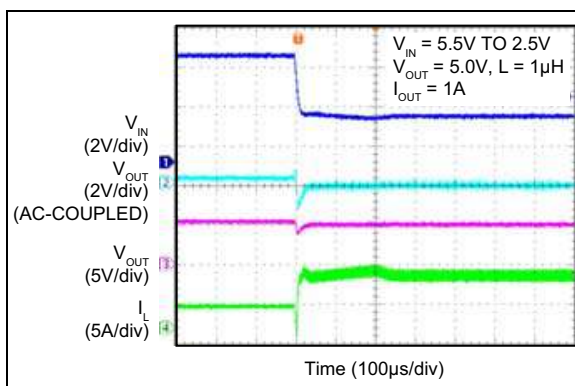
**FIGURE 2-16:** Output Ripple (Pulse Skipping Mode).



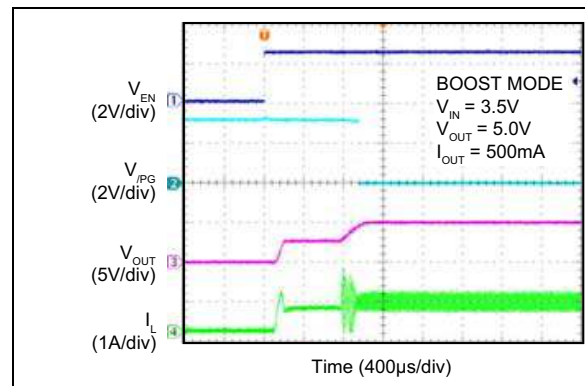
**FIGURE 2-14:** Line Transient (2.5V to 5.5V).



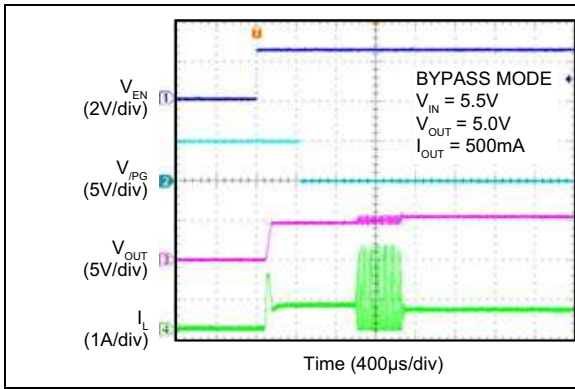
**FIGURE 2-17:** Output Ripple (PWM Mode).



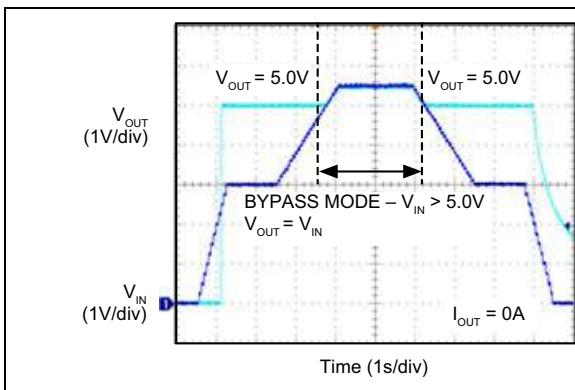
**FIGURE 2-15:** Line Transient (5.5V to 2.5V).



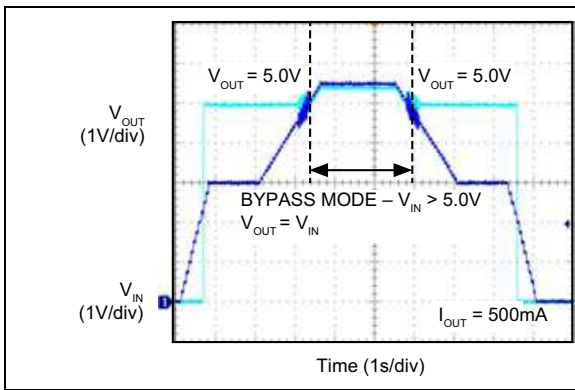
**FIGURE 2-18:** Soft-Start (Boost Mode).



**FIGURE 2-19:** *Soft-Start (Bypass Mode).*



**FIGURE 2-20:** *Bypass Mode.*



**FIGURE 2-21:** *Bypass Mode.*

## 3.0 PIN DESCRIPTIONS

The descriptions of the pins are listed in [Table 3-1](#).

**TABLE 3-1: PIN FUNCTION TABLE**

Pin Number Fixed Output	Pin Number Adj. Output	Pin Name	Description
1	1	SW	Boost Converter Switch Node: Connect the inductor between IN and SW pins.
2	2	PGND	Power Ground: The power ground for the synchronous boost DC/DC converter power stage.
3	3	IN	Supply Input: Connect at least 1 $\mu$ F ceramic capacitor between IN and AGND pins.
4	4	AGND	Analog Ground: The analog ground for the regulator control loop.
5	—	OUTS	Output Voltage Sense Pin: For output voltage regulation in fixed voltage version. Connect to the boost converter output.
—	5	FB	Feedback Pin: For output voltage regulation in adjustable version. Connect to the feedback resistor divider.
6	6	EN	Boost Converter Enable: When this pin is driven low, the IC enters shutdown mode. The EN pin has an internal 2.5 M $\Omega$ pull-down resistor. The output is disabled when this pin is left floating.
7	7	/PG	Open Drain Power Good Output (Active Low): The /PG pin is high impedance when the output voltage is below the power good threshold and becomes low once the output is above the power good threshold. The /PG pin has a typical $R_{DS(ON)} = 90\Omega$ and requires a pull up resistor of 1 M $\Omega$ . Connect /PG pin to AGND when the /PG signal is not used.
8	8	OUT	Boost Converter Output.
EP	EP	ePad	Exposed Heat Sink Pad. Connect to AGND for best thermal performance.

# MIC2876

---

## 4.0 FUNCTIONAL DESCRIPTION

### 4.1 Input (IN)

The input supply provides power to the internal MOSFET's gate drivers and control circuitry for the boost regulator. The operating input voltage range is from 2.5V to 5.5V. A 1  $\mu$ F low-ESR ceramic input capacitor should be connected from IN to AGND as close to MIC2876 as possible to ensure a clean supply voltage for the device. A minimum voltage rating of 10V is recommended for the input capacitor.

### 4.2 Switch Node (SW)

The MIC2876 has internal low-side and synchronous MOSFET switches. The switch node (SW) between the internal MOSFET switches connects directly to one end of the inductor and provides the current path during switching cycles. The other end of the inductor is connected to the input supply voltage. Due to the high-speed switching on this pin, the switch node should be routed away from sensitive nodes wherever possible.

### 4.3 Ground Path (AGND)

The ground path (AGND) is for the internal biasing and control circuitry. AGND should be connected to the PCB pad for the package exposed pad. The current loop of the analog ground should be separated from that of the power ground (PGND). AGND should be connected to PGND at a single point.

### 4.4 Power Ground (PGND)

The power ground (PGND) is the ground path for the high current in the boost switches. The current loop for the power ground should be as short as possible and separate from the AGND loop as applicable.

### 4.5 Boost Converter Output (OUT)

A low-ESR ceramic capacitor of 22  $\mu$ F (for operation with  $V_{IN} \leq 5.0V$ ), or 66  $\mu$ F (for operation with  $V_{IN} > 5.0V$ ) should be connected from  $V_{OUT}$  and PGND as close as possible to the MIC2876. A minimum voltage rating of 10V is recommended for the output capacitor.

### 4.6 Enable (EN)

Enable pin of the MIC2876. A logic high on this pin enables the MIC2876. When this pin is driven low, the MIC2876 enters the shutdown mode. When the EN pin is left floating, it is pulled-down internally by a built-in 2.5 M $\Omega$  resistor.

### 4.7 Feedback/Output Voltage Sense (FB/OUTS)

Feedback or output voltage sense pin for the boost converter. For the fixed voltage version, this pin should be connected to the OUT pin. For the adjustable version, connect a resistor divider to set the output voltage (see “[Output Voltage Programming](#)” for more information).

### 4.8 Power Good Output (/PG)

The open-drain active-low power-good output (/PG) is low when the output voltage is above the power-good threshold. A pull-up resistor of 1 M $\Omega$  is recommended.

### 4.9 Exposed Heat Sink Pad (EP)

The exposed heat sink pad, or ePad (EP), should be connected to AGND for best thermal performance.

## 5.0 APPLICATION INFORMATION

### 5.1 General Description

The MIC2876 is a 2 MHz, current-mode, PWM, synchronous boost converter with an operating input voltage range of 2.5V to 5.5V. At light load, the converter enters pulse-skipping mode to maintain high efficiency over a wide range of load current. The maximum peak current in the boost switch is limited to 4.8A (typical).

### 5.2 Bi-Directional Output Disconnect

The power stage of the MIC2876 consists of a NMOS transistor as the main switch and a PMOS transistor as the synchronous rectifier. A control circuit turns off the back gate diode of the PMOS to isolate the output from the input supply when the chip is disabled ( $V_{EN} = 0V$ ). An “always on” maximum supply selector switches the cathode of the backgate diode to either the IN or the OUT (whichever of the two has the higher voltage). As a result, the output of the MIC2876 is bi-directionally isolated from the input as long as the device is disabled. The maximum supply selector and hence the output disconnect function requires only 0.3V at the IN pin to operate.

### 5.3 Integrated Anti-Ringing Switch

The MIC2876 includes an anti-ringing switch that eliminates the ringing on the SW node of a conventional boost converter operating in the discontinuous conduction mode (DCM). At the end of a switching cycle during DCM operation, both the NMOS and PMOS are turned off. The anti-ringing switch in the MIC2876 clamps the SW pin voltage to IN to dissipate the remaining energy stored in the inductor and the parasitic elements of the power switches.

### 5.4 Automatic Bypass Mode

The MIC2876 automatically operates in bypass mode when the input voltage is higher than the target output voltage. In bypass mode, the NMOS is turned off while the PMOS is fully turned on to provide a very low impedance path from IN to OUT.

### 5.5 Soft-Start

The MIC2876 integrates an internal soft-start circuit to limit the inrush current during start-up. When the device is enabled, the PMOS is turned-on slowly to charge the output capacitor to a voltage close to the input voltage. Then, the device begins boost switching cycles to gradually charge up the output voltage to the target  $V_{OUT}$ .

### 5.6 Output Voltage Programming

The MIC2876 has an adjustable version that allows the output voltage to be set by an external resistor divider R2 and R3. The typical feedback voltage is 900 mV, the recommended maximum and minimum output voltage is 5.5V and 3.2V, respectively. The current through the resistor divider should be significantly larger than the current into the FB pin (typically 0.01  $\mu A$ ). It is recommended that 0.1% tolerance feedback resistors must be used and the total resistance of R2 + R3 should be around 1 M $\Omega$ . The appropriate R2 and R3 values for the desired output voltage are calculated as in Equation 5-1:

#### EQUATION 5-1:

$$R2 = R3 \times \left( \frac{V_{OUT}}{0.9V} - 1 \right)$$

Example 1:

With a  $V_{OUT}$  of 3.3V and an R3 value of 281.2 k $\Omega$  (standard value is 280 k $\Omega$ ), R2 calculates out to 750 k $\Omega$ .

Example 2:

With a  $V_{OUT}$  of 5V and an R3 value of 200 k $\Omega$ , R2 calculates out to 911.1 k $\Omega$  (standard value is 910 k $\Omega$ ).

### 5.7 Current Limit Protection

The MIC2876 has a current limit feature to protect the part against heavy load conditions. When the current limit comparator determines that the NMOS switch has a peak current higher than 4.8A, the NMOS is turned off and the PMOS is turned on until the next switching cycle. The current limit protection is reset cycle by cycle.

## 6.0 COMPONENT SELECTION

### 6.1 Inductor

Inductor selection is a trade-off between efficiency, stability, cost, size, and rated current. Because the boost converter is compensated internally, the recommended inductance is limited from 1  $\mu\text{H}$  to 2.2  $\mu\text{H}$  to ensure system stability and presents a good balance between these considerations.

A large inductance value reduces the peak-to-peak inductor ripple current hence the output ripple voltage. This also reduces both the DC loss and the transition loss at the same inductor's DC resistance (DCR). However, the DCR of an inductor usually increases with the inductance in the same package size. This is due to the longer windings required for an increase in inductance. Since the majority of the input current passes through the inductor, the higher the DCR the lower the efficiency is, and more significantly at higher load currents. On the other hand, inductor with smaller DCR but the same inductance usually has a larger size. The saturation current rating of the selected inductor must be higher than the maximum peak inductor current to be encountered and should be at least 20% to 30% higher than the average inductor current at maximum output current.

### 6.2 Input Capacitor to the Device Supply

A ceramic capacitor of 1  $\mu\text{F}$  or larger with low ESR is recommended to reduce the input voltage ripple to ensure a clean supply voltage for the device. The input capacitor should be placed as close as possible to the MIC2876 IN and AGND pins with short traces to ensure good noise performance. X5R or X7R type ceramic capacitors are recommended for better tolerance over temperature. The Y5V and Z5U type temperature rating ceramic capacitors are not recommended due to their large reduction in capacitance over temperature and increased resistance at high frequencies. The use of these reduces their ability to filter out high-frequency noise. The rated voltage of the input capacitor should be at least 20% higher than the maximum operating input voltage over the operating temperature range.

### 6.3 Input Capacitor to the Power Path

A ceramic capacitor of a 4.7  $\mu\text{F}$  or larger with low ESR is recommended to reduce the input voltage fluctuation at the voltage supply of the high-current power path. An input capacitor should be placed close to the  $V_{\text{IN}}$  supply to the power inductor and PGND for good device performance at heavy load condition. X5R- or X7R-type ceramic capacitors are recommended for better tolerance over temperature.

The Y5V and Z5U type temperature rating ceramic capacitors are not recommended due to their large reduction in capacitance over temperature and increased resistance at high frequencies. These reduce their ability to filter out high-frequency noise. The rated voltage of the input capacitor should be at least 20% higher than the maximum operating input voltage over the operating temperature range.

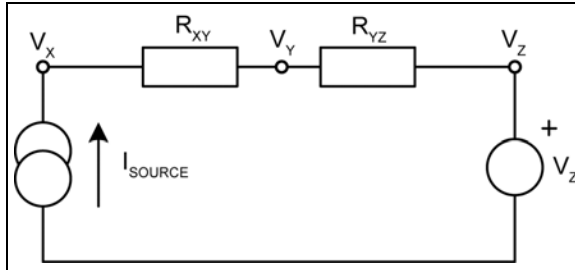
### 6.4 Output Capacitor

Output capacitor selection is also a trade-off between performance, size, and cost. Increasing the output capacitor will lead to an improved transient response; however, the size and cost also increase. For operation with  $V_{\text{IN}} \leq 5.0\text{V}$ , a minimum of 22  $\mu\text{F}$  output capacitor with ESR less than 10  $\text{m}\Omega$  is required. For operation with  $V_{\text{IN}} > 5.0\text{V}$ , a minimum of 66  $\mu\text{F}$  output capacitor with ESR less than 10  $\text{m}\Omega$  is required. X5R or X7R type ceramic capacitors are recommended for better tolerance over temperature. Additional capacitors can be added to improve the transient response, and to reduce the ripple of the output when the MIC2876 operates in and out of bypass mode.

The Y5V and Z5U type ceramic capacitors are not recommended due to their wide variation in capacitance over temperature and increased resistance at high frequencies. The rated voltage of the output capacitor should be at least 20% higher than the maximum operating output voltage over the operating temperature range. 0805 size ceramic capacitor is recommended for smaller ESL at output capacitor which contributes smaller voltage spike at the output voltage of high-frequency switching boost converter.

## 7.0 POWER DISSIPATION

As with all power devices, the ultimate current rating of the output is limited by the thermal properties of the device package and the PCB on which the device is mounted. There is a simple, Ohm's law-type relationship between thermal resistance, power dissipation, and temperature which are analogous to an electrical circuit (see [Figure 7-1](#)):



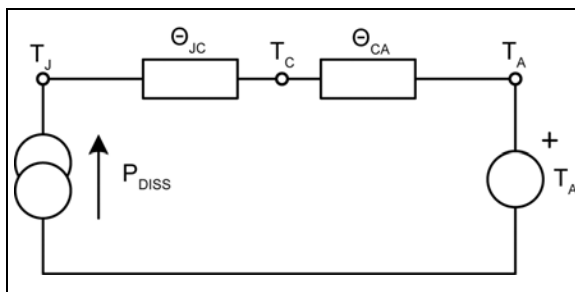
**FIGURE 7-1:** Series Electrical Resistance Circuit.

From this simple circuit we can calculate  $V_X$  if we know  $I_{SOURCE}$ ,  $V_Z$ , and the resistor values,  $R_{XY}$  and  $R_{YZ}$  using [Equation 7-1](#):

**EQUATION 7-1:**

$$V_X = I_{SOURCE} \times (R_{XY} + R_{YZ}) + V_Z$$

Thermal circuits can be considered using this same rule and can be drawn similarly by replacing current sources with power dissipation (in watts), resistance with thermal resistance (in °C/W) and voltage sources with temperature (in °C).



**FIGURE 7-2:** Series Thermal Resistance Circuit.

Now replacing the variables in the equation for  $V_X$ , we can find the junction temperature ( $T_J$ ) from the power dissipation, ambient temperature and the known thermal resistance of the PCB ( $\theta_{CA}$ ) and the package ( $\theta_{JC}$ ).

**EQUATION 7-2:**

$$T_J = P_{DISS} \times (\theta_{JC} + \theta_{CA}) + T_A$$

As can be seen in the diagram, total thermal resistance  $\theta_{JA} = \theta_{JC} + \theta_{CA}$ . This can also be written as in [Equation 7-3](#):

**EQUATION 7-3:**

$$T_J = P_{DISS} \times (\theta_{JA}) + T_A$$

Given that all of the power losses (minus the inductor losses) are effectively in the converter are dissipated within the MIC2876 package,  $P_{DISS}$  can be calculated thusly:

**EQUATION 7-4: LINEAR MODE**

$$P_{DISS} = \left[ P_{OUT} \times \left( \frac{1}{\eta} - 1 \right) \right] - I_{OUT}^2 \times DCR$$

**EQUATION 7-5: BOOST MODE**

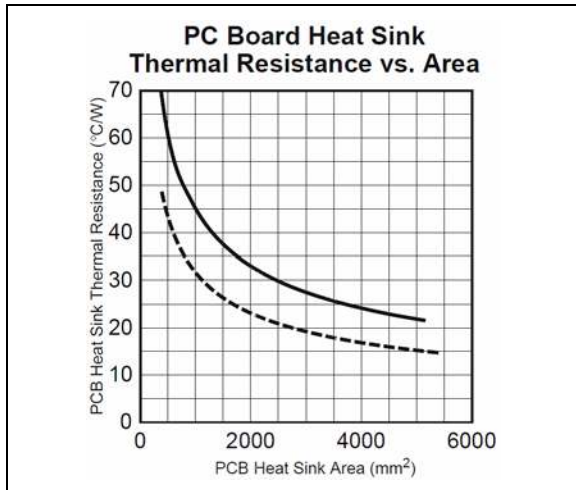
$$P_{DISS} = \left[ P_{OUT} \times \left( \frac{1}{\eta} - 1 \right) \right] - \left( \frac{I_{OUT}}{1-D} \right)^2 \times DCR$$

**EQUATION 7-6: DUTY CYCLE (BOOST)**

$$D + \frac{V_{OUT} - V_{IN}}{V_{OUT}}$$

In the equations above,  $\eta$  is the efficiency taken from the efficiency curves and DCR represents the inductor DCR.  $\theta_{JC}$  and  $\theta_{JA}$  are found in the temperature specifications section of the data sheet.

Where the real board area differs from 1" square,  $\theta_{CA}$  (the PCB thermal resistance), values for various PCB copper areas can be taken from [Figure 7-3](#).



**FIGURE 7-3:** *Determining PCB Area for a Given PCB Thermal Resistance.*

Figure 7-3 shows the total area of a round or square pad, centered on the device. The solid trace represents the area of a square, single-sided, horizontal, solder masked, copper PC board trace heat sink, measured in square millimeters. No airflow is assumed. The dashed line shows the PC board's trace heat sink covered in black oil-based paint and with 1.3 m/sec (250 feet per minute) airflow. This approaches a "best case" pad heat sink. Conservative design dictates using the solid trace data, which indicates that a maximum pad size of 5000 mm<sup>2</sup> is needed. This is a pad 71 mm × 71 mm (2.8 inches per side).



## 8.0 PCB LAYOUT GUIDELINES

PCB layout is critical to achieve reliable, stable and efficient performance. A ground plane is required to control EMI and minimize the inductance in power, signal and return paths. The following guidelines should be followed to ensure proper operation of the device. Please refer to the MIC2876 evaluation board document for the recommended placement and layout of components.

### 8.1 Integrated Circuit (IC)

- Place the IC close to the point-of-load.
- Use fat traces to route the input and output power lines.
- Analog grounds and power ground should be kept separate and connected at a single location at the PCB pad for exposed pad of the IC.
- Place as many thermal vias as possible on the PCB pad for the exposed pad and connect it to the ground plane to ensure a good PCB thermal resistance.

### 8.2 IN Decoupling Capacitor

- The IN decoupling capacitor must be placed close to the IN pin of the IC and preferably connected directly to the pin and not through any via. The capacitor must be located right at the IC.
- The IN decoupling capacitor should be connected as close as possible to AGND.
- The IN terminal is noise sensitive and the placement of capacitor is very critical.

### 8.3 $V_{IN}$ Power Path Bulk Capacitor

- The  $V_{IN}$  power path bulk capacitor should be placed and connected close to the  $V_{IN}$  supply to the power inductor and the PGND of the IC.
- Use either X5R or X7R temperature rating ceramic capacitors. Do not use Y5V or Z5U type ceramic capacitors.

### 8.4 Inductor

- Keep both the inductor connections to the switch node (SW) and input power line short and wide enough to handle the switching current. Keep the areas of the switching current loops small to minimize the EMI problem.
- Do not route any digital lines underneath or close to the inductor.
- Keep the switch node (SW) away from the noise sensitive pins.
- To minimize noise, place a ground plane underneath the inductor.

### 8.5 Output Capacitor

- Use wide and short traces to connect the output capacitor as close as possible to the OUT and PGND pins without going through via holes to minimize the switching current loop during the main switch off cycle and the switching noise.
- Use either X5R or X7R temperature rating ceramic capacitors. Do not use Y5V or Z5U type ceramic capacitors.

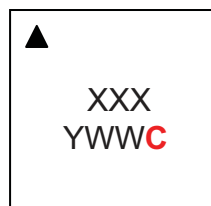
# MIC2876

---

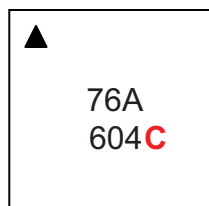
## 9.0 PACKAGING INFORMATION

### 9.1 Package Marking Information

8-Pin UDFN



Example



<b>Legend:</b>	XX...X	Product code or customer-specific information
	Y	Year code (last digit of calendar year)
	YY	Year code (last 2 digits of calendar year)
	WW	Week code (week of January 1 is week '01')
	NNN	Alphanumeric traceability code
	(e3)	Pb-free JEDEC® designator for Matte Tin (Sn)
	*	This package is Pb-free. The Pb-free JEDEC designator ((e3)) can be found on the outer packaging for this package.
	•, ▲, ▼	Pin one index is identified by a dot, delta up, or delta down (triangle mark).
<b>Note:</b>	In the event the full Microchip part number cannot be marked on one line, it will be carried over to the next line, thus limiting the number of available characters for customer-specific information. Package may or may not include the corporate logo.	
	Underbar ( _ ) symbol may not be to scale.	

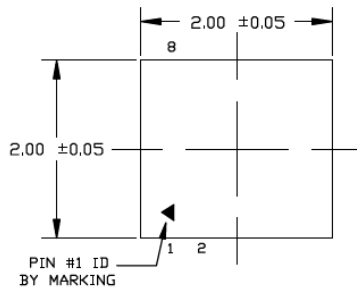
## 8-Lead UDFN 2 mm x 2 mm Package Outline and Recommended Land Pattern

**Note:** For the most current package drawings, please see the Microchip Packaging Specification located at <http://www.microchip.com/packaging>

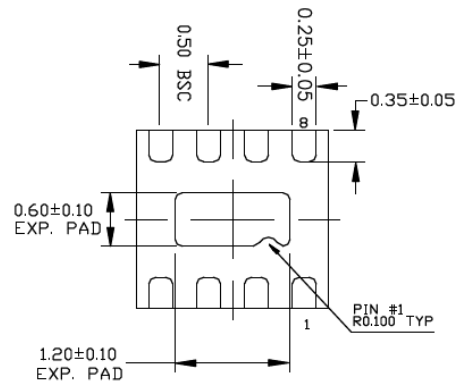
**TITLE**

8 LEAD TDFN 2x2mm PACKAGE OUTLINE & RECOMMENDED LAND PATTERN

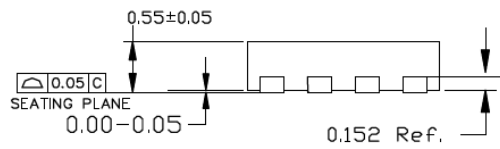
DRAWING #	TDFN22-8LD-PL-1	UNIT	MM
-----------	-----------------	------	----



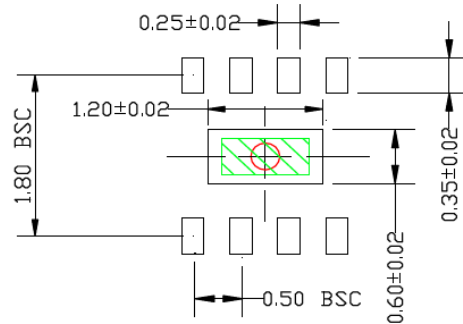
**TOP VIEW**  
NOTE: 1, 2, 3



**BOTTOM VIEW**  
NOTE: 1, 2, 3



**END VIEW**  
NOTE: 1, 2, 3



**RECOMMENDED LAND PATTERN**  
NOTE: 4, 5

- NOTE:
1. MAX PACKAGE WARPAGE IS 0.05 MM
  2. MAX ALLOWABLE BURR IS 0.076MM IN ALL DIRECTIONS
  3. PIN #1 IS ON TOP WILL BE LASER MARKED
  4. RED CIRCLE IN LAND PATTERN REPRESENTS THERMAL VIA. SIZE SHOULD BE 0.30-0.3 MM IN DIAMETER AND SHOULD BE CONNECTED TO GND FOR MAX THERMAL PERFORMANCE
  5. GREEN RECTANGLES (SHADED AREA) REPRESENTS SOLDER STENCIL OPENING ON EXPOSED PAD AREA. SIZE SHOULD BE 0.40x0.90 MM.

# MIC2876

---

NOTES:

## APPENDIX A: REVISION HISTORY

### Revision A (July 2016)

- Converted Micrel document MIC2876 to Microchip data sheet DS20005572A.
- Minor text changes throughout.
- Updated TDFN package information to Microchip-standard UDFN.

# MIC2876

---

NOTES:

## PRODUCT IDENTIFICATION SYSTEM

To order or obtain information, e.g., on pricing or delivery, contact your local Microchip representative or sales office.

<u>PART NO.</u>	-	<u>XX</u>	<u>X</u>	<u>XX</u>	-	<u>XX</u>
Device		Output Voltage	Temperature	Package		Media Type
<b>Device:</b>	MIC2876:	4.8A I <sub>SW</sub> , Synchronous Boost Regulator with Bi-Directional Load Disconnect				
<b>Output Voltage:</b>	4.75 = 4.75V					
	5.0 = 5.00V					
	5.25 = 5.25V					
	5.5 = 5.50V					
	A = Adjustable					
<b>Temperature:</b>	Y = -40°C to +125°C					
<b>Package:</b>	MT = 8-Pin 2 mm x 2 mm UDFN					
<b>Media Type:</b>	T5 = 500/Reel					
	TR = 5,000/Reel					
<b>Examples:</b>						
a)	MIC2876-4.75YMT-T5:	MIC2876, 4.75V Output Voltage, -40°C to +125°C Temp. Range, 8-Pin UDFN, 500/Reel				
b)	MIC2876-4.75YMT-TR:	MIC2876, 4.75V Output Voltage, -40°C to +125°C Temp. Range, 8-Pin UDFN, 5,000/Reel				
c)	MIC2876-5.0YMT-T5:	MIC2876, 5.00V Output Voltage, -40°C to +125°C Temp. Range, 8-Pin UDFN, 500/Reel				
d)	MIC2876-5.0YMT-TR:	MIC2876, 5.00V Output Voltage, -40°C to +125°C Temp. Range, 8-Pin UDFN, 5,000/Reel				
e)	MIC2876-5.25YMT-T5:	MIC2876, 5.25V Output Voltage, -40°C to +125°C Temp. Range, 8-Pin UDFN, 500/Reel				
f)	MIC2876-5.25YMT-TR:	MIC2876, 5.25V Output Voltage, -40°C to +125°C Temp. Range, 8-Pin UDFN, 5,000/Reel				
g)	MIC2876-5.5YMT-T5:	MIC2876, 5.50V Output Voltage, -40°C to +125°C Temp. Range, 8-Pin UDFN, 500/Reel				
h)	MIC2876-5.5YMT-TR:	MIC2876, 5.50V Output Voltage, -40°C to +125°C Temp. Range, 8-Pin UDFN, 5,000/Reel				
i)	MIC2876-AYMT-T5:	MIC2876, Adjustable Output Voltage, -40°C to +125°C Temp. Range, 8-Pin UDFN, 500/Reel				
j)	MIC2876-AYMT-TR:	MIC2876, Adjustable Output Voltage, -40°C to +125°C Temp. Range, 8-Pin UDFN, 5,000/Reel				

# MIC2876

---

NOTES:



---

---

**Note the following details of the code protection feature on Microchip devices:**

- Microchip products meet the specification contained in their particular Microchip Data Sheet.
- Microchip believes that its family of products is one of the most secure families of its kind on the market today, when used in the intended manner and under normal conditions.
- There are dishonest and possibly illegal methods used to breach the code protection feature. All of these methods, to our knowledge, require using the Microchip products in a manner outside the operating specifications contained in Microchip's Data Sheets. Most likely, the person doing so is engaged in theft of intellectual property.
- Microchip is willing to work with the customer who is concerned about the integrity of their code.
- Neither Microchip nor any other semiconductor manufacturer can guarantee the security of their code. Code protection does not mean that we are guaranteeing the product as “unbreakable.”

Code protection is constantly evolving. We at Microchip are committed to continuously improving the code protection features of our products. Attempts to break Microchip's code protection feature may be a violation of the Digital Millennium Copyright Act. If such acts allow unauthorized access to your software or other copyrighted work, you may have a right to sue for relief under that Act.

---

Information contained in this publication regarding device applications and the like is provided only for your convenience and may be superseded by updates. It is your responsibility to ensure that your application meets with your specifications. MICROCHIP MAKES NO REPRESENTATIONS OR WARRANTIES OF ANY KIND WHETHER EXPRESS OR IMPLIED, WRITTEN OR ORAL, STATUTORY OR OTHERWISE, RELATED TO THE INFORMATION, INCLUDING BUT NOT LIMITED TO ITS CONDITION, QUALITY, PERFORMANCE, MERCHANTABILITY OR FITNESS FOR PURPOSE. Microchip disclaims all liability arising from this information and its use. Use of Microchip devices in life support and/or safety applications is entirely at the buyer's risk, and the buyer agrees to defend, indemnify and hold harmless Microchip from any and all damages, claims, suits, or expenses resulting from such use. No licenses are conveyed, implicitly or otherwise, under any Microchip intellectual property rights unless otherwise stated.

*Microchip received ISO/TS-16949:2009 certification for its worldwide headquarters, design and wafer fabrication facilities in Chandler and Tempe, Arizona; Gresham, Oregon and design centers in California and India. The Company's quality system processes and procedures are for its PIC® MCUs and dsPIC® DSCs, KEELoc® code hopping devices, Serial EEPROMs, microperipherals, nonvolatile memory and analog products. In addition, Microchip's quality system for the design and manufacture of development systems is ISO 9001:2000 certified.*

**QUALITY MANAGEMENT SYSTEM  
CERTIFIED BY DNV  
= ISO/TS 16949 =**

### **Trademarks**

The Microchip name and logo, the Microchip logo, AnyRate, dsPIC, FlashFlex, flexPWR, Heldo, JukeBlox, KeeLoq, KeeLoq logo, Klear, LANCheck, LINK MD, MediaLB, MOST, MOST logo, MPLAB, OptoLyzer, PIC, PICSTART, PIC32 logo, RightTouch, SpyNIC, SST, SST Logo, SuperFlash and UNI/O are registered trademarks of Microchip Technology Incorporated in the U.S.A. and other countries.

ClockWorks, The Embedded Control Solutions Company, ETHERSYNCH, Hyper Speed Control, HyperLight Load, IntelliMOS, mTouch, Precision Edge, and QUIET-WIRE are registered trademarks of Microchip Technology Incorporated in the U.S.A.

Analog-for-the-Digital Age, Any Capacitor, AnyIn, AnyOut, BodyCom, chipKIT, chipKIT logo, CodeGuard, dsPICDEM, dsPICDEM.net, Dynamic Average Matching, DAM, ECAN, EtherGREEN, In-Circuit Serial Programming, ICSP, Inter-Chip Connectivity, JitterBlocker, KlearNet, KlearNet logo, MiWi, motorBench, MPASM, MPF, MPLAB Certified logo, MPLIB, MPLINK, MultiTRAK, NetDetach, Omniscient Code Generation, PICDEM, PICDEM.net, PICkit, PICtail, PureSilicon, RightTouch logo, REAL ICE, Ripple Blocker, Serial Quad I/O, SQL, SuperSwitcher, SuperSwitcher II, Total Endurance, TSHARC, USBCheck, VariSense, ViewSpan, WiperLock, Wireless DNA, and ZENA are trademarks of Microchip Technology Incorporated in the U.S.A. and other countries.

SQTP is a service mark of Microchip Technology Incorporated in the U.S.A.

Silicon Storage Technology is a registered trademark of Microchip Technology Inc. in other countries.

GestIC is a registered trademarks of Microchip Technology Germany II GmbH & Co. KG, a subsidiary of Microchip Technology Inc., in other countries.

All other trademarks mentioned herein are property of their respective companies.

© 2016, Microchip Technology Incorporated, Printed in the U.S.A., All Rights Reserved.

ISBN: 978-1-5224-0760-7



# MICROCHIP

## Worldwide Sales and Service

### AMERICAS

#### Corporate Office

2355 West Chandler Blvd.  
Chandler, AZ 85224-6199  
Tel: 480-792-7200  
Fax: 480-792-7277  
Technical Support:  
<http://www.microchip.com/support>

Web Address:  
[www.microchip.com](http://www.microchip.com)

#### Atlanta

Duluth, GA  
Tel: 678-957-9614  
Fax: 678-957-1455

#### Austin, TX

Tel: 512-257-3370

#### Boston

Westborough, MA  
Tel: 774-760-0087  
Fax: 774-760-0088

#### Chicago

Itasca, IL  
Tel: 630-285-0071  
Fax: 630-285-0075

#### Cleveland

Independence, OH  
Tel: 216-447-0464  
Fax: 216-447-0643

#### Dallas

Addison, TX  
Tel: 972-818-7423  
Fax: 972-818-2924

#### Detroit

Novi, MI  
Tel: 248-848-4000

#### Houston, TX

Tel: 281-894-5983

#### Indianapolis

Noblesville, IN  
Tel: 317-773-8323  
Fax: 317-773-5453

#### Los Angeles

Mission Viejo, CA  
Tel: 949-462-9523  
Fax: 949-462-9608

#### New York, NY

Tel: 631-435-6000

#### San Jose, CA

Tel: 408-735-9110

#### Canada - Toronto

Tel: 905-695-1980  
Fax: 905-695-2078

### ASIA/PACIFIC

#### Asia Pacific Office

Suites 3707-14, 37th Floor  
Tower 6, The Gateway  
Harbour City, Kowloon

#### Hong Kong

Tel: 852-2943-5100  
Fax: 852-2401-3431

#### Australia - Sydney

Tel: 61-2-9868-6733  
Fax: 61-2-9868-6755

#### China - Beijing

Tel: 86-10-8569-7000  
Fax: 86-10-8528-2104

#### China - Chengdu

Tel: 86-28-8665-5511  
Fax: 86-28-8665-7889

#### China - Chongqing

Tel: 86-23-8980-9588  
Fax: 86-23-8980-9500

#### China - Dongguan

Tel: 86-769-8702-9880

#### China - Guangzhou

Tel: 86-20-8755-8029

#### China - Hangzhou

Tel: 86-571-8792-8115  
Fax: 86-571-8792-8116

#### China - Hong Kong SAR

Tel: 852-2943-5100  
Fax: 852-2401-3431

#### China - Nanjing

Tel: 86-25-8473-2460  
Fax: 86-25-8473-2470

#### China - Qingdao

Tel: 86-532-8502-7355  
Fax: 86-532-8502-7205

#### China - Shanghai

Tel: 86-21-5407-5533  
Fax: 86-21-5407-5066

#### China - Shenyang

Tel: 86-24-2334-2829  
Fax: 86-24-2334-2393

#### China - Shenzhen

Tel: 86-755-8864-2200  
Fax: 86-755-8203-1760

#### China - Wuhan

Tel: 86-27-5980-5300  
Fax: 86-27-5980-5118

#### China - Xian

Tel: 86-29-8833-7252  
Fax: 86-29-8833-7256

### ASIA/PACIFIC

#### China - Xiamen

Tel: 86-592-2388138  
Fax: 86-592-2388130

#### China - Zhuhai

Tel: 86-756-3210040  
Fax: 86-756-3210049

#### India - Bangalore

Tel: 91-80-3090-4444  
Fax: 91-80-3090-4123

#### India - New Delhi

Tel: 91-11-4160-8631  
Fax: 91-11-4160-8632

#### India - Pune

Tel: 91-20-3019-1500

#### Japan - Osaka

Tel: 81-6-6152-7160  
Fax: 81-6-6152-9310

#### Japan - Tokyo

Tel: 81-3-6880-3770  
Fax: 81-3-6880-3771

#### Korea - Daegu

Tel: 82-53-744-4301  
Fax: 82-53-744-4302

#### Korea - Seoul

Tel: 82-2-554-7200  
Fax: 82-2-558-5932 or  
82-2-558-5934

#### Malaysia - Kuala Lumpur

Tel: 60-3-6201-9857  
Fax: 60-3-6201-9859

#### Malaysia - Penang

Tel: 60-4-227-8870  
Fax: 60-4-227-4068

#### Philippines - Manila

Tel: 63-2-634-9065  
Fax: 63-2-634-9069

#### Singapore

Tel: 65-6334-8870  
Fax: 65-6334-8850

#### Taiwan - Hsin Chu

Tel: 886-3-5778-366  
Fax: 886-3-5770-955

#### Taiwan - Kaohsiung

Tel: 886-7-213-7828

#### Taiwan - Taipei

Tel: 886-2-2508-8600  
Fax: 886-2-2508-0102

#### Thailand - Bangkok

Tel: 66-2-694-1351  
Fax: 66-2-694-1350

### EUROPE

#### Austria - Wels

Tel: 43-7242-2244-39  
Fax: 43-7242-2244-393

#### Denmark - Copenhagen

Tel: 45-4450-2828  
Fax: 45-4485-2829

#### France - Paris

Tel: 33-1-69-53-63-20  
Fax: 33-1-69-30-90-79

#### Germany - Dusseldorf

Tel: 49-2129-3766400

#### Germany - Karlsruhe

Tel: 49-721-625370

#### Germany - Munich

Tel: 49-89-627-144-0  
Fax: 49-89-627-144-44

#### Italy - Milan

Tel: 39-0331-742611  
Fax: 39-0331-466781

#### Italy - Venice

Tel: 39-049-7625286

#### Netherlands - Drunen

Tel: 31-416-690399  
Fax: 31-416-690340

#### Poland - Warsaw

Tel: 48-22-3325737

#### Spain - Madrid

Tel: 34-91-708-08-90  
Fax: 34-91-708-08-91

#### Sweden - Stockholm

Tel: 46-8-5090-4654

#### UK - Wokingham

Tel: 44-118-921-5800  
Fax: 44-118-921-5820

06/23/16