

LOC		DIST		REVISIONS			
CM	00	P	LTB	DESCRIPTION	DATE	DWN	APVD
		01		REV PER ECO 09-025493	16NOV09	JR	MS

1. DIMENSIONS IN BRACKETS ARE IN INCHES.
 2. MATERIAL - DUST COVER: BLACK ASA
 CABLE: 1.588 [.0625] FINISHED OD VINYL
 COATED CABLE, 266.7 [10.50] LONG
 SLEEVE: 1.588 [.0625] ALUMINUM OVAL

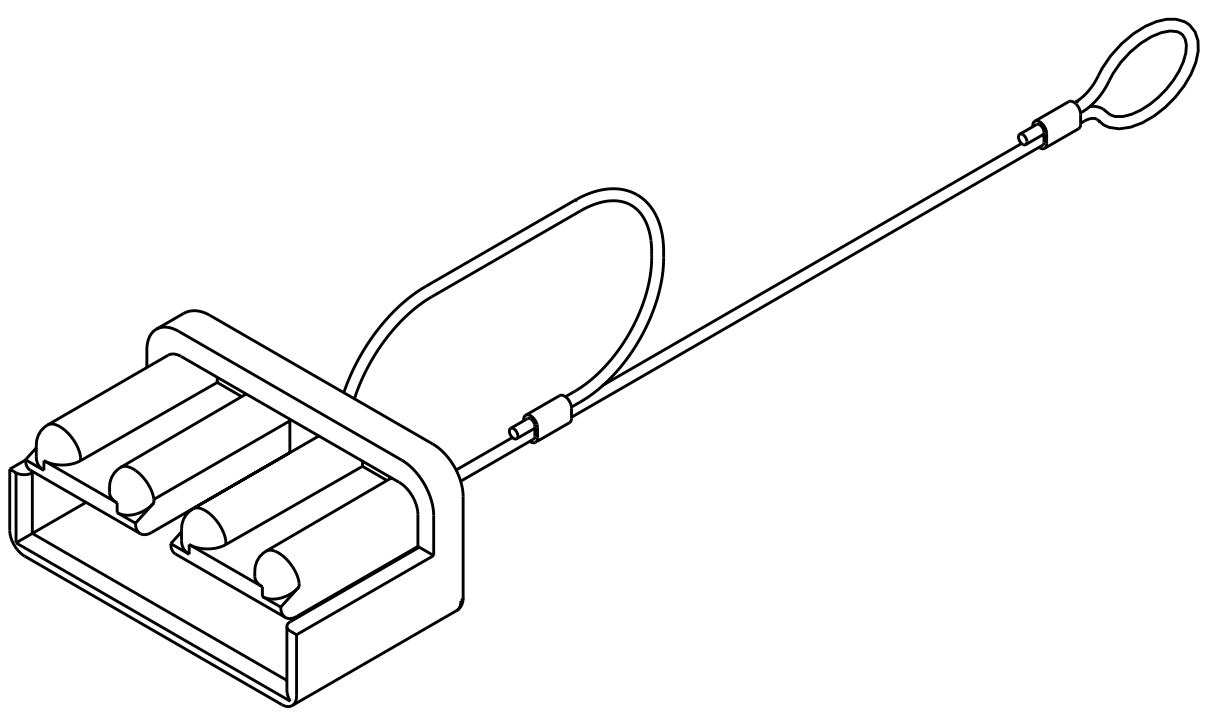

3 DIMENSIONAL VIEW
 SCALE 1:1

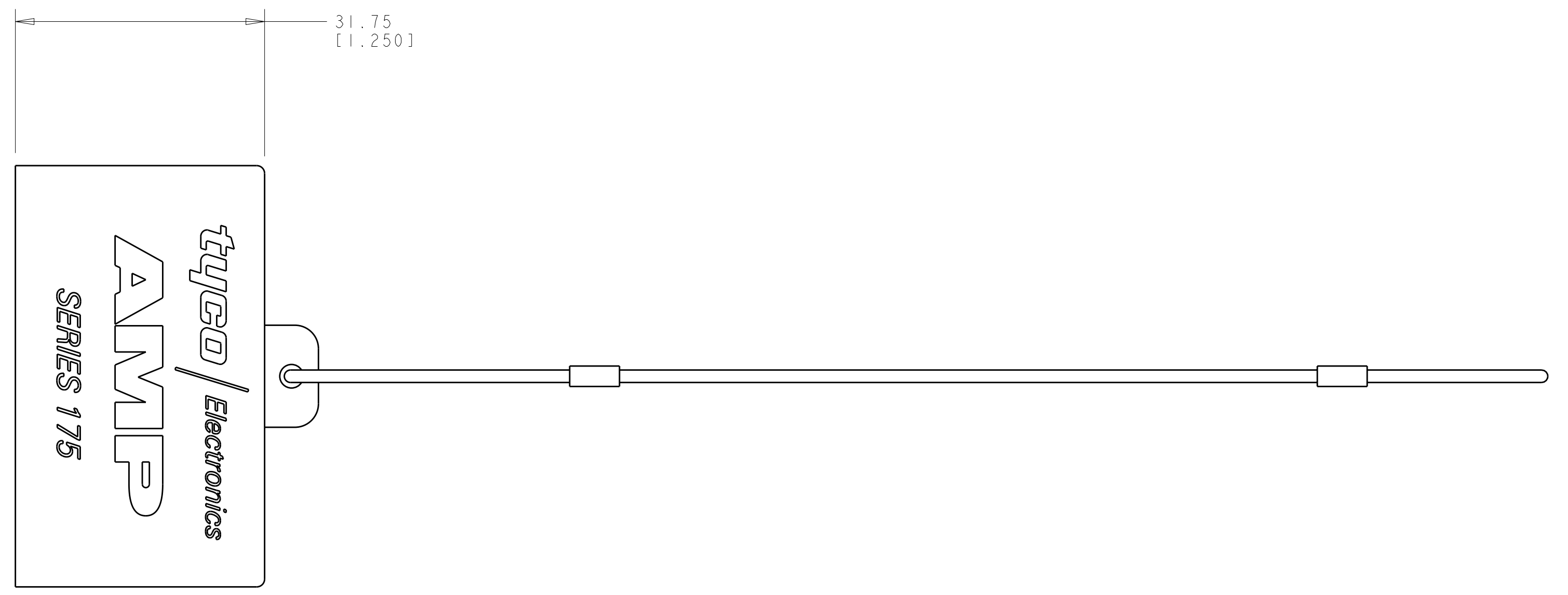
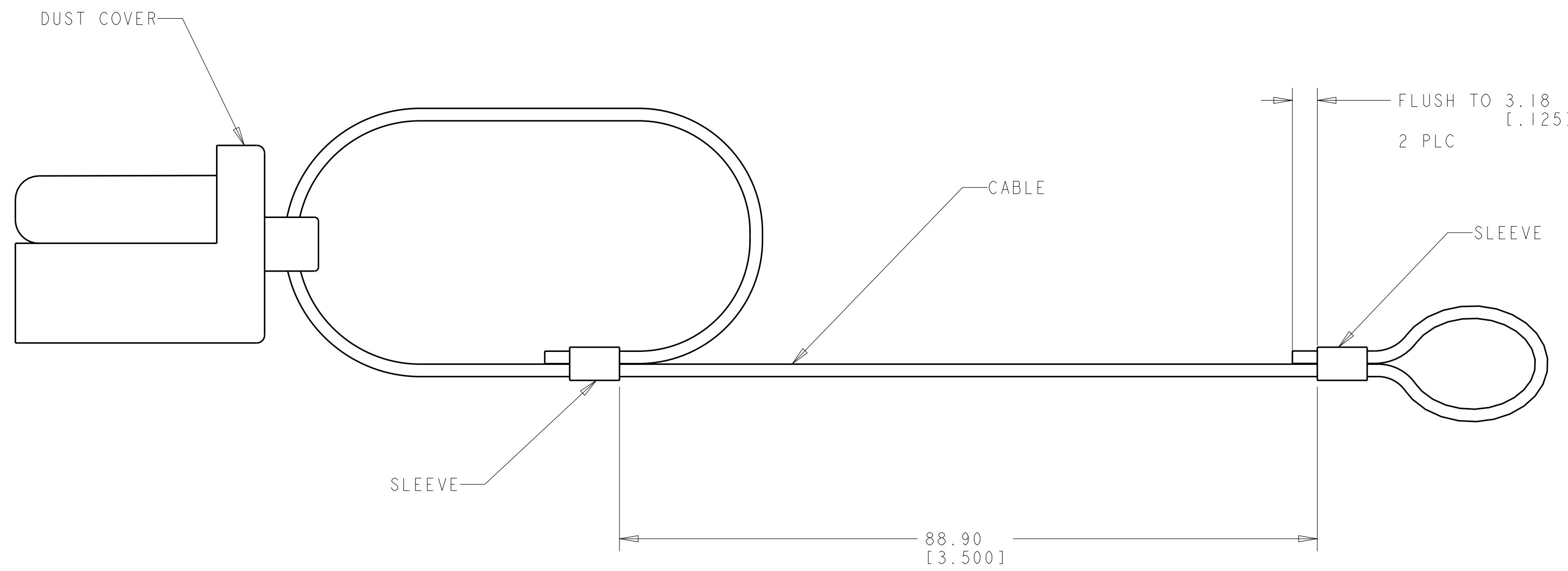
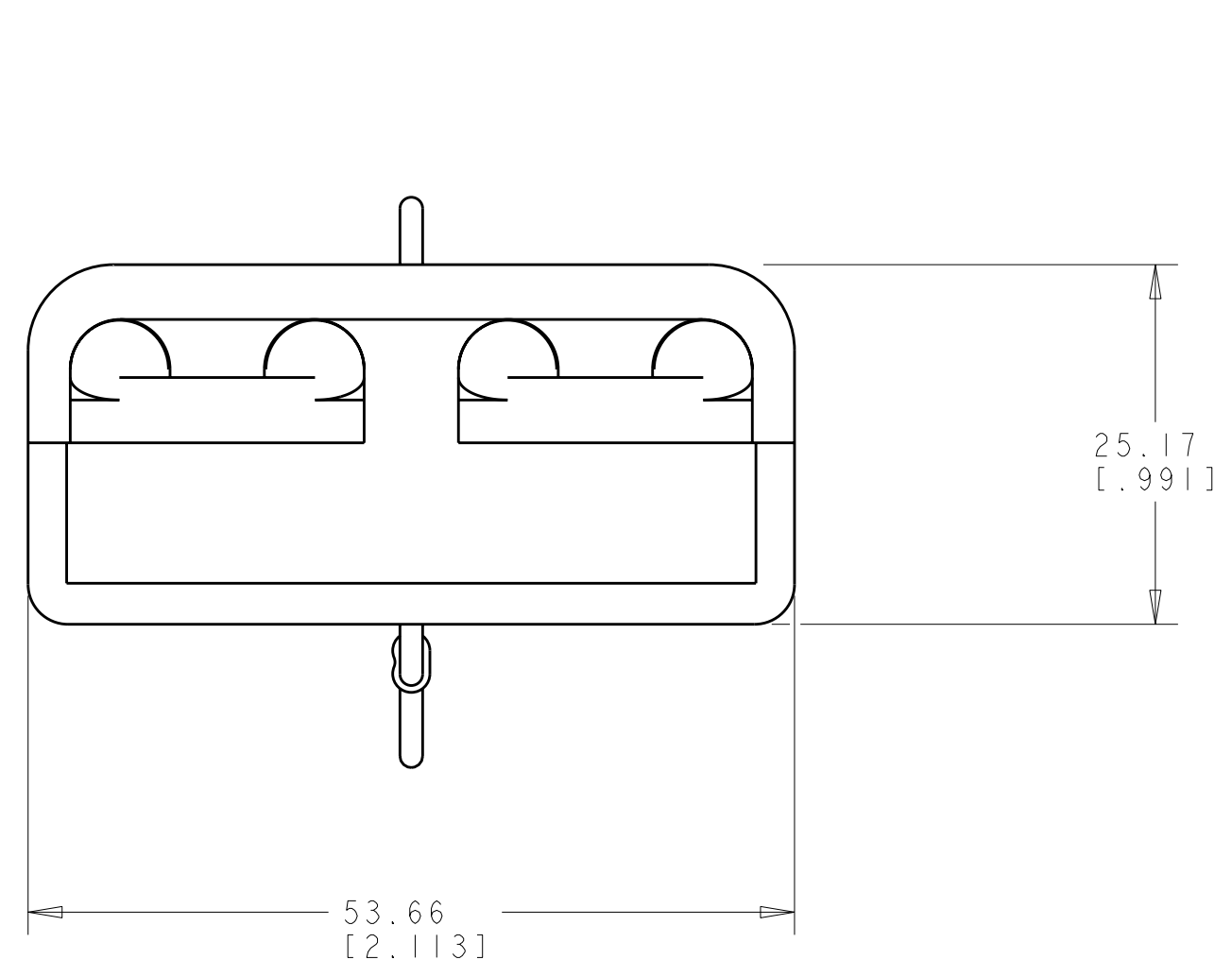

647691-1
 PART NUMBER

<small>THIS DRAWING IS UNPUBLISHED. RELEASED FOR PUBLICATION BY TYCO ELECTRONICS CORPORATION. ALL RIGHTS RESERVED.</small>		DWN: R. WHITAKER 31 JUL 2003 CHK: J. ELLIS 31 JUL 2003 APVD: J. ELLIS 31 JUL 2003	Tyco Electronics Harrisburg, PA 17105-3608
DIMENSIONS: mm [INCHES]	TOLERANCES UNLESS OTHERWISE SPECIFIED: 9 PLC ± 1 PLC ± 2 PLC ±0.2 [.125] 3 PLC ± 4 PLC ± ANGLES ±40° 30'	NAME: DUST COVER ASSEMBLY, AMP POWER SERIES 175 PRODUCT SPEC: APPLICATION SPEC: WEIGHT:	SIZE: A1 CAGE CODE: 00779 DRAWING NO: C-647691 RESTRICTED TO:
MATERIAL:		FINISH:	CUSTOMER DRAWING SCALE: 2:1 SHEET: 1 OF 1 REV: 01