



Positive Lock | Mark II, Positive Lock 187

TE Internal #: 170325-5

Quick Disconnects, Receptacle, 20 – 16 AWG Wire Size, .51 – 1.31 mm<sup>2</sup> Wire Size, Mating Tab Width 4.75 mm [.187 in], Straight, Brass, Positive Lock 187

[View on TE.com >](#)

Terminals & Splices > Quick Disconnects

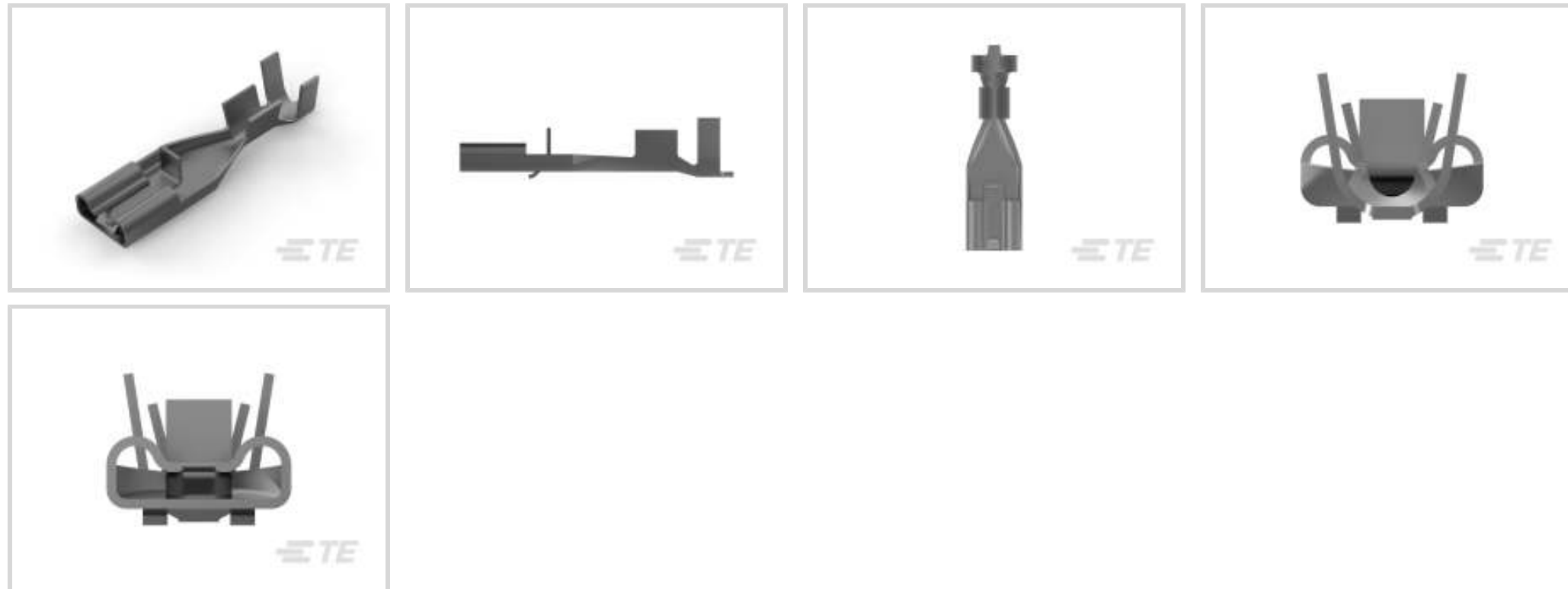

Quick Disconnect Terminal Type: **Receptacle**

Wire Size: .51 – 1.31 mm<sup>2</sup>

Mating Tab Width: 4.75 mm [.187 in]

Mating Tab Thickness: .51 mm [.02 in]

**Features**

**Product Type Features**

Insertion Force	Low
-----------------	-----

**Configuration Features**

Compatible With Wire & Cable Type	Discrete Wire
-----------------------------------	---------------

**Contact Features**

Quick Disconnect Terminal Type	Receptacle
Mating Tab Width	4.75 mm [.187 in]
Mating Tab Thickness	.51 mm [.02 in]
Terminal Orientation	Straight
Contact Base Material	Brass
Terminal Plating Material	Pre-Tin
Crimp Type	F-Crimp
Barrel Type	Open

**Termination Features**

Product Terminates To	Wire & Cable
-----------------------	--------------



### Mechanical Attachment

Extraction Force	7 – 100 Newton
Wire Insulation Support	With
Mating Retention Type	Dimple

### Dimensions

Terminal Material Thickness	.3 mm[.012 in]
Product Length	21.6 mm[.85 in]
Compatible Insulation Diameter Range	1.9 – 3.4 mm[.075 – .134 in]
Wire Size	.51 – 1.31 mm <sup>2</sup>

### Usage Conditions

Insulation Option	Uninsulated
Operating Temperature Range	-40 – 110 °C[-40 – 230 °F]

### Industry Standards

Agency/Standard	UL
-----------------	----

### Packaging Features

Packaging Quantity	6000
Packaging Method	Strip/Reel

### Other

Terminals & Splices Comment	Air-feed Applicator should be used.
-----------------------------	-------------------------------------

### Product Compliance











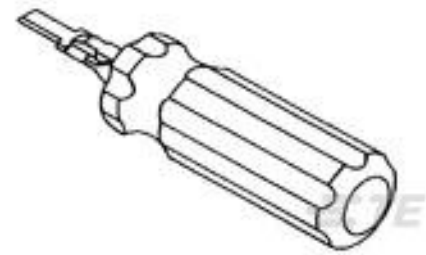

[For compliance documentation, visit the product page on TE.com>](#)

EU RoHS Directive 2011/65/EU	Compliant
EU ELV Directive 2000/53/EC	Compliant
China RoHS 2 Directive MIIT Order No 32, 2016	No Restricted Materials Above Threshold
EU REACH Regulation (EC) No. 1907/2006	Current ECHA Candidate List: JUNE 2023 (235) Candidate List Declared Against: JAN 2023 (233) Does not contain REACH SVHC
Halogen Content	Low Halogen - Br, Cl, F, I < 900 ppm per homogenous material. Also BFR/CFR/PVC Free
Solder Process Capability	Not applicable for solder process capability

Product Compliance Disclaimer

This information is provided based on reasonable inquiry of our suppliers and represents our current actual knowledge based on the information they provided. This information is subject to change. The part numbers that TE has identified as EU RoHS compliant have a maximum concentration of 0.1% by weight in homogenous materials for lead, hexavalent chromium, mercury, PBB, PBDE, DBP, BBP, DEHP, DIBP, and 0.01% for cadmium, or qualify for an exemption to these limits as defined in the Annexes of Directive 2011/65/EU (RoHS2). Finished electrical and electronic equipment products will be CE marked as required by Directive 2011/65/EU. Components may not be CE marked. Additionally, the part numbers that TE has identified as EU ELV compliant have a maximum concentration of 0.1% by weight in homogenous materials for lead, hexavalent chromium, and mercury, and 0.01% for cadmium, or qualify for an exemption to these limits as defined in the Annexes of Directive 2000/53/EC (ELV). Regarding the REACH Regulation, the information TE provides on SVHC in articles for this part number is based on the latest European Chemicals Agency (ECHA) 'Guidance on requirements for substances in articles' posted at this URL: <https://echa.europa.eu/guidance-documents/guidance-on-reach>

## Compatible Parts

 <p>TE Part # 724659-1 EXT TOOL FOR POSITIVE .187</p>	 <p>TE Part # 172075-1 POSITIVE LOCK 187 HOUSING RECEPTACLE</p>	 <p>TE Part # 1-172075-1 3 POS PL 187(4.8 MM) HOUSING NATURAL</p>	 <p>TE Part # 173974-6 PL MKII 187 REC HSG 1P NYLON BLUE</p>
 <p>TE Part # 174513-1 PL 187 HOUSING RECEPTACLE</p>	 <p>TE Part # 1-174587-1 PL MK2 2P 187 HOUSING RECEPTACLE NAT</p>	 <p>TE Part # 176498-1 POSITIVE LOCK 187 (4.8 MM) HOUSING</p>	 <p>TE Part # 1-174712-1 187 HSG. PL MKII REC. 6.65mm 2P NAT</p>
 <p>TE Part # 174712-1 PL 187 (4.8 MM) HOUSING RECEPTACLE</p>	 <p>TE Part # 172074-1 187 HSG. PLMKII REC. NAT</p>	 <p>TE Part # 173974-1 187 HSG. PL MKII REC. NAT</p>	 <p>TE Part # 176498-4 POSITIVE LOCK 187 (4.8 MM) HOUSING</p>



Also in the Series | **Mark II**

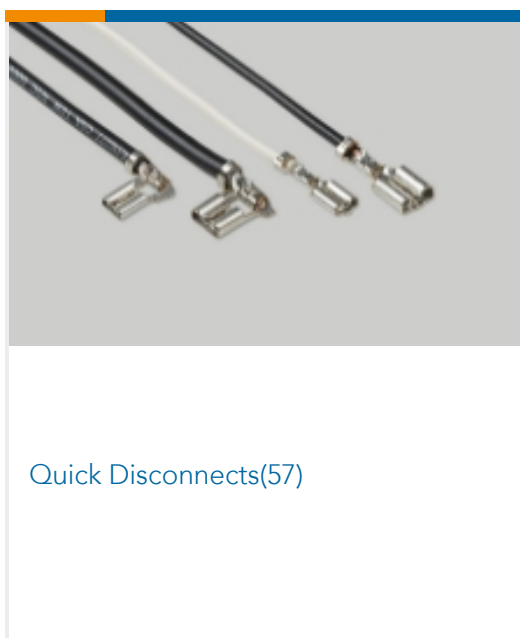
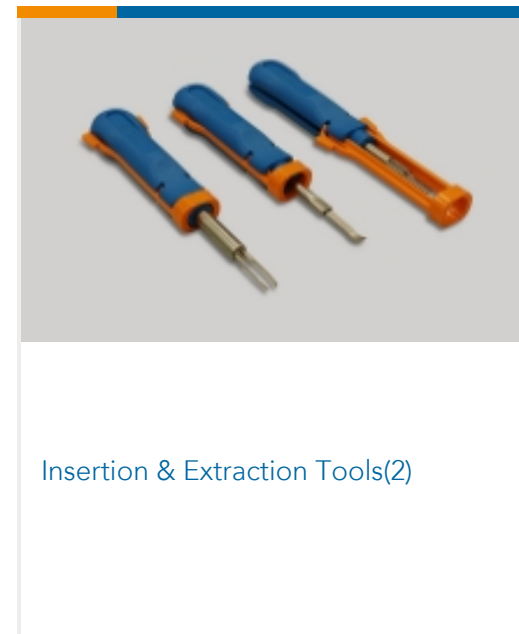
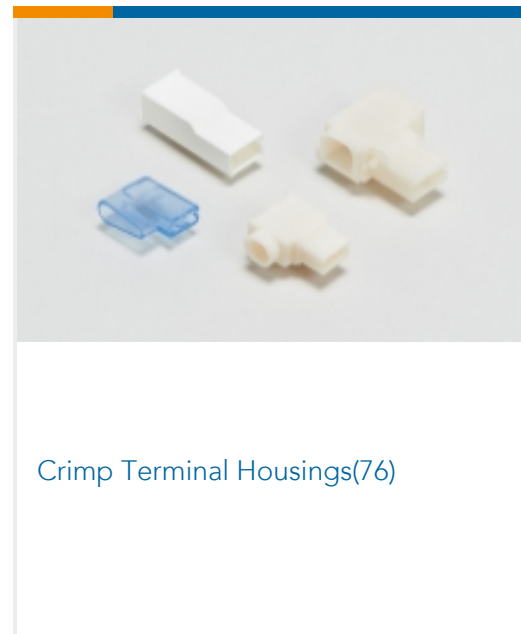
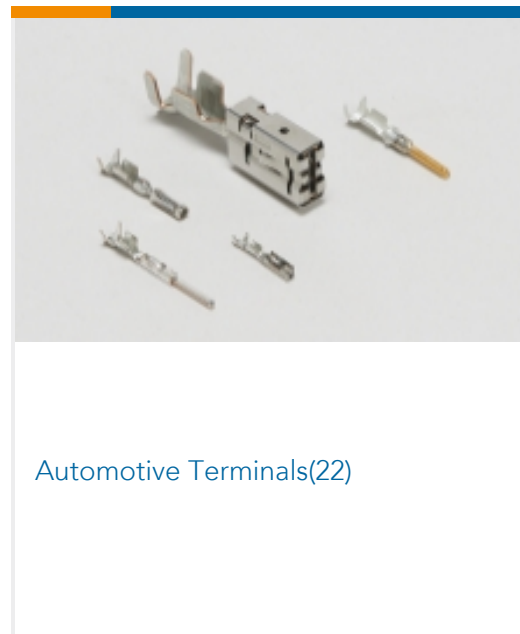
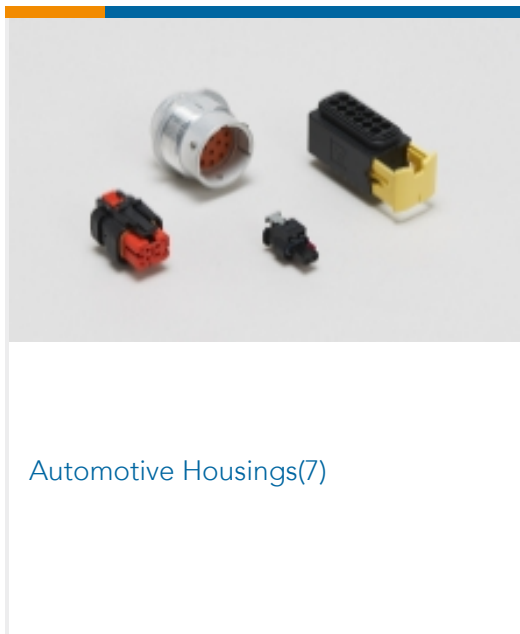

Also in the Series | **Positive Lock 187**

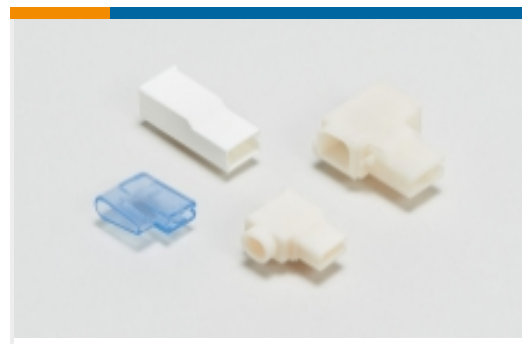

Crimp Terminal Housings(86)

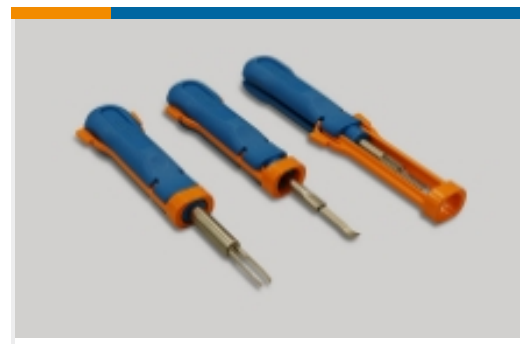

Insertion &amp; Extraction Tools(2)



Insulation Boots &amp; Sleeves(7)

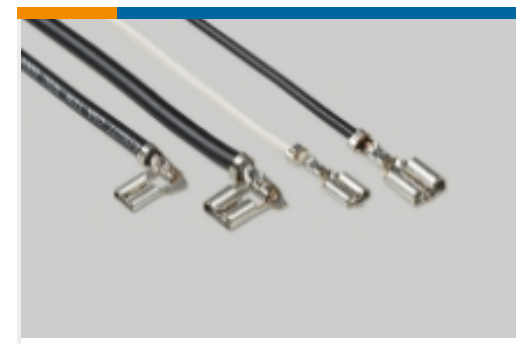

Quick Disconnects(55)

## Customers Also Bought

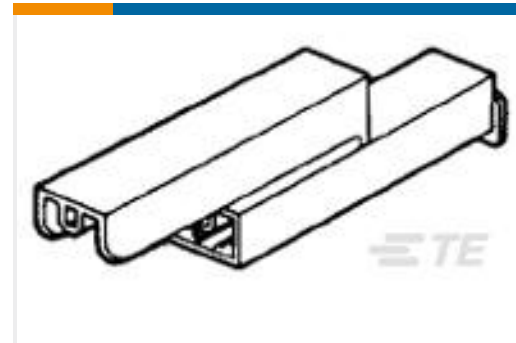
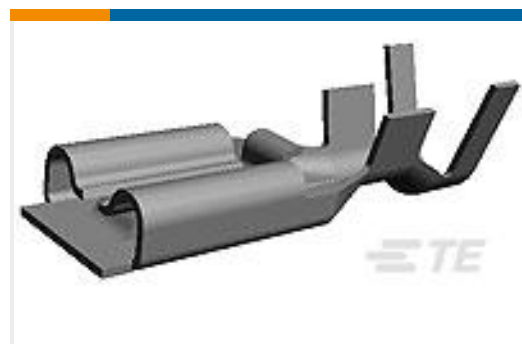
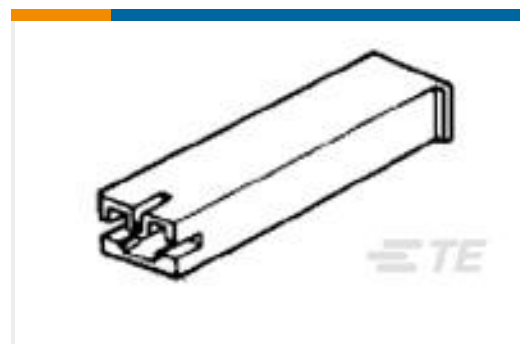
TE Part #1565084-1  
GRACE INERTIA CONNECTOR 3.5 6PTE Part #175149-1  
UNIVERSAL POWER CONN TABTE Part #1-174712-1  
187 HSG. PL MKII REC. 6.65mm 2P  
NATTE Part #175057-2  
250 PL EX FLAG REC. 18-12AWG PTBRTE Part #175034-1  
PL 187 REC 20-14 AWG 0.30 X 14.0 SSTE Part #173974-1  
187 HSG. PL MKII REC. NATTE Part #179975-1  
250 PL EX REC. 15-10AWG PTBRTE Part #170213-1  
250 FASTON,REC.,18-14 AWG,BRTE Part #1983780-1  
NG GIC 3.3 REC CONTACT TIN PLATE

## Documents

### CAD Files

[3D PDF](#)

[3D](#)

### Customer View Model

[ENG\\_CVM\\_CVM\\_170325-5\\_T.2d\\_dxf.zip](#)

English

### Customer View Model

[ENG\\_CVM\\_CVM\\_170325-5\\_T.3d\\_igs.zip](#)



English

**Customer View Model**

[ENG\\_CVM\\_CVM\\_170325-5\\_T.3d\\_stp.zip](#)

English

By downloading the CAD file I accept and agree to the [Terms and Conditions](#) of use.

---

**Product Specifications**

[Application Specification](#)

English

---

**Product Environmental Compliance**

[TE Material Declaration](#)

English

---

**Instruction Sheets**

[Instruction Sheet \(non U.S.\)](#)

English

[AMP\\* POSITIVE LOCK CONNECTOR](#)

English

---

**Agency Approvals**

[UL Report](#)

English