

CA081, CA082, CA084**BiMOS Operational Amplifiers**

With MOS/FET Input, Composite Bipolar/MOS Output

Single Amplifier: CA081 Dual Amplifier: CA082, Quad Amplifier: CA084**Features:**

- *Very low input bias and offset currents*
- *Input impedance typically $1.5 \times 10^{12} \Omega$*
- *Low input offset voltage*
- *Wide common-mode input voltage range*
- *Low power consumption*
- *Fast slew rate*
- *Unity-gain bandwidth = 5 MHz [typ.]*
- *Wide output voltage swing*
- *Low distortion*
- *Continuous short circuit protection*
- *Direct replacement for industry type TL080 series in most applications*

The RCA-CA081, CA082, and CA084 BiMOS operational amplifiers combine the advantages of MOS and bipolar transistors on the same monolithic chip. The gate-protected MOS/FET (PMOS) input transistors provide high input impedance and a wide common-mode input voltage range. The bipolar and MOS output transistors allow a wide output voltage swing and provide a high output current capability.

The CA081, CA082, and CA084 are internally phase-compensated. All types except the CA082 have provisions for external offset nulling.

These types have an operating-temperature range of 0 to +70°C.

Applications:

- *Inverters*
- *High-Q notch filters*
- *IC preamplifiers*
- *Unity Gain Absolute Value Amplifiers*
- *Sample and hold amplifiers*
- *Active filters*

The CA081 and CA082 types are supplied in the 8-lead dual-in-line plastic package (E suffix). The CA084 types are supplied in the 14-lead dual-in-line plastic package (E suffix). They are also available in chip form (H suffix).

MAXIMUM RATINGS, Absolute Maximum Values:

DC SUPPLY VOLTAGE V_{\pm}	±18 V
DIFFERENTIAL INPUT VOLTAGE	±16 V
INPUT VOLTAGE RANGE	±15 V
INPUT CURRENT	1 mA
OUTPUT SHORT-CIRCUIT DURATION	UNLIMITED*
POWER DISSIPATION, P_D :	
At $T_A = 25^\circ\text{C}$	625 mW
Derating Factors:	
Mini-DIP	Derate linearly at 6.67 mW/°C above 56°C
14-Lead DIP	Derate linearly at 6.67 mW/°C above 56°C
AMBIENT TEMPERATURE RANGE	0 to +70°C
STORAGE TEMPERATURE RANGE, ALL TYPES	-65 to +150°C
LEAD TEMPERATURE (DURING SOLDERING):	
At distance 1/16 ± 1/32 (1.59 ± 0.79 mm) from case for 10 seconds max.	+265°C

*The output may be shorted to ground or either supply if the maximum temperature and dissipation ratings are observed.

CA081, CA082, CA084

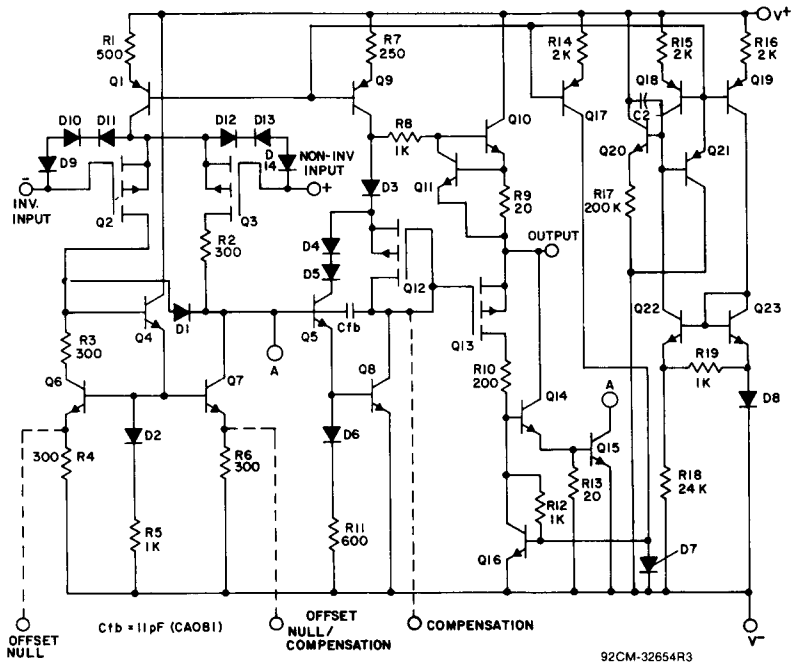
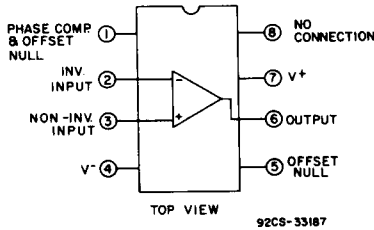
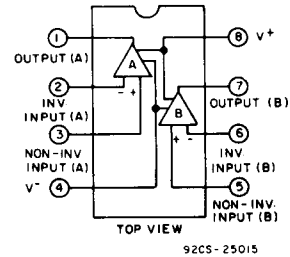

Fig. 1 - Schematic diagram of the CA081, CA082, and CA084.



CA081
E Suffix



CA082
E Suffix

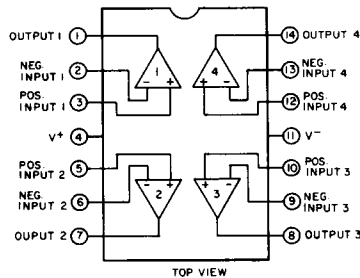

CA084
E Suffix

Fig. 2 - Terminal assignments.

CA081, CA082, CA084

TYPICAL OPERATING CHARACTERISTICS at
 $V_{\pm} = 15\text{ V}$, $T_A = 25^{\circ}\text{C}$

CHARACTERISTIC	TEST CONDITIONS	VALUE	UNITS
Slew Rate at Unity Gain, SR	$V_I = 10\text{ V}$, $R_L = 2\text{ k}\Omega$, $C_L = 100\text{ pF}$, $A_{VD} = 1$	13	$\text{V}/\mu\text{s}$
Rise Time, t_r	$V_I = 10\text{ V}$, $R_L = 2\text{ k}\Omega$, $C_L = 100\text{ pF}$, $A_{VD} = 1$	0.1	μs
Overshoot Factor	$C_L = 100\text{ pF}$, $A_{VD} = 1$	10	%
Equivalent Input Noise Voltage, e_n	$R_S = 100\ \Omega$, $f = 1\text{ kHz}$	40	$\text{nV}/\sqrt{\text{Hz}}$

ELECTRICAL CHARACTERISTICS at $T_A = 25^{\circ}\text{C}$, $T_A = 0\text{ to }+70^{\circ}\text{C}$ $V_{\pm} = \pm 15\text{ V}$

CHARACTERISTIC	TEST CONDITIONS	LIMITS			UNITS		
		CA081AE CA082AE CA084AE					
		Min.	Typ.	Max.			
Input Offset Voltage, V_{IO}	$R_S = 50\ \Omega$	X	—	3	6	mV	
			X	—	—		7.5
Temperature Coefficient of Input Offset Voltage, αV_{IO}	$R_S = 50\ \Omega$		X	—	10	—	$\mu\text{V}/^{\circ}\text{C}$
Input Offset Current, I_{IO}		X	—	5	20	pA	
			X	—	—	0.6	nA
Input Current		X	—	15	40	pA	
			X	—	—	1	nA
Common-Mode Input Voltage Range, V_{ICR}		X		± 12	—	—	V
Maximum Output Voltage Swing, V_{OP-P}	$R_L = 10\text{ k}\Omega$	X		24	27	—	V
	$R_L > 10\text{ k}\Omega$		X	24	—	—	
	$R_L > 2\text{ k}\Omega$		X	20	24	—	
Large-Signal Differential Voltage Gain, A_{VD}	$R_L > 2\text{ k}\Omega$, $V_O = \pm 10\text{ V}$	X		50	200	—	V/mV
			X	—	—	—	
Unity-Gain Bandwidth		X		—	5	—	MHz
Input Resistance, R_I		X		—	1.5	—	$\text{T}\Omega$
Common-Mode Rejection Ratio, CMRR	$R_S < 10\text{ k}\Omega$	X		80	86	—	dB
Power Supply Rejection Ratio, PSRR ($\Delta V + / \pm \Delta V_{IO}$)	$R_S < 10\text{ k}\Omega$	X		80	86	—	dB
Supply Current, I^+ (per ampl., CA082, CA084)	No load, No Signal	X		—	1.4	2.8	mA
Channel Separation, V_{O1}/V_{O2} (between ampl., CA082)	$A_{VD} = 100$	X		—	120	—	dB

CA081, CA082, CA084

ELECTRICAL CHARACTERISTICS at $T_A = 25^\circ\text{C}$, $T_A = 0$ to 70°C $v_{\pm} = \pm 15\text{ V}$

CHARACTERISTIC	TEST CONDITIONS	LIMITS			UNITS		
		CA081E CA082E CA084E					
		Min.	Typ.	Max.			
Input Offset Voltage, V_{IO}	$R_S = 50\ \Omega$	X	—	5	15	mV	
		X	—	—	20		
Temperature Coefficient of Input Offset Voltage, αV_{IO}	$R_S = 50\ \Omega$		X	—	10	—	$\mu\text{V}/^\circ\text{C}$
Input Offset Current, I_{IO}		X		—	5	30	pA
			X	—	—	1	nA
Input Current		X		—	15	50	pA
			X	—	—	2	nA
Common-Mode Input Voltage Range, V_{ICR}		X		± 10	—	—	V
Maximum Output Voltage Swing, V_{OP-P}	$R_L = 10\ \text{k}\Omega$	X		24	27	—	V
	$R_L \geq 10\ \text{k}\Omega$		X	24	—	—	
	$R_L \geq 2\ \text{k}\Omega$		X	20	24	—	
Large-Signal Differential Voltage Gain, A_{VD}	$R_L \geq 2\ \text{k}\Omega$, $V_O = \pm 10\text{ V}$	X		25	200	—	V/mV
			X	—	—	—	
Unity-Gain Bandwidth		X		—	5	—	MHz
Input Resistance, R_i		X		—	1.5	—	$\text{T}\Omega$
Common-Mode Rejection Ratio, CMRR	$R_S < 10\ \text{k}\Omega$	X		70	76	—	dB
Power Supply Rejection Ratio, PSRR ($\Delta V \pm / \pm \Delta V_{IO}$)	$R_S < 10\ \text{k}\Omega$	X		70	76	—	dB
Supply Current, I^+ (per ampl., CA082, CA084)	No load, No Signal	X		—	1.4	2.8	mA
Channel Separation, V_{O1}/V_{O2} (between ampl., CA082)	$A_{VD} = 100$	X		—	120	—	dB

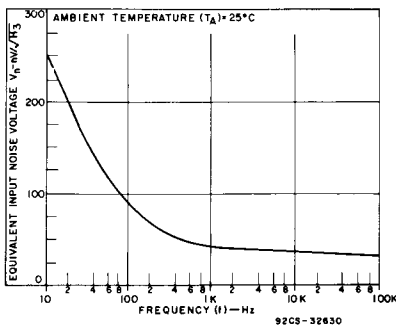

Fig. 3 - Noise voltage as a function of frequency.

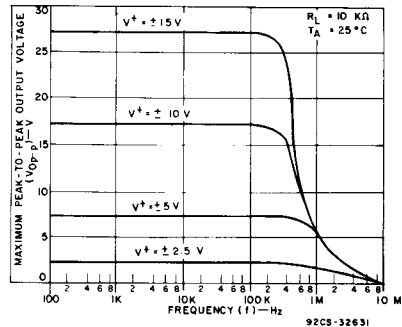

Fig. 4 - Output voltage as a function of frequency.

CA081, CA082, CA084

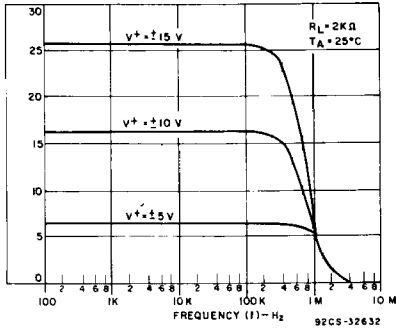

Fig. 5 - Output voltage as a function of frequency.

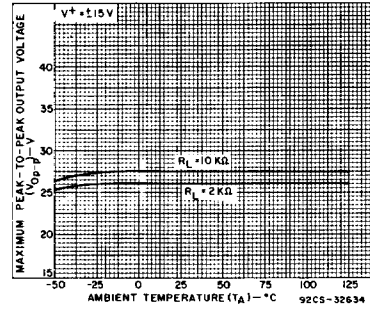

Fig. 6 - Output voltage as a function of ambient temperature.

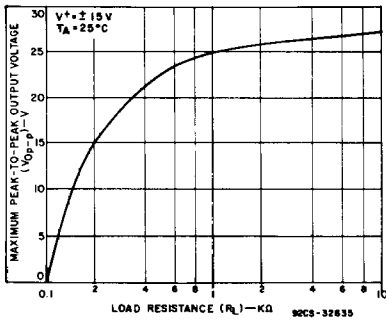

Fig. 7 - Output voltage as a function of load resistance.

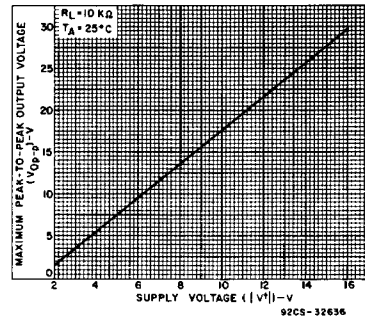

Fig. 8 - Output voltage as a function of supply voltage.

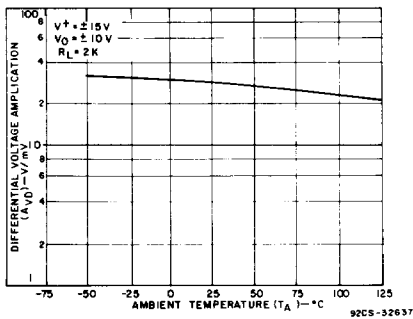

Fig. 9 - Differential voltage amplification as a function of ambient temperature.

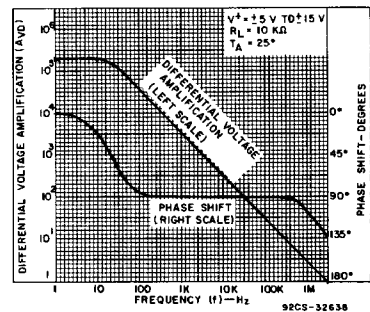

Fig. 10 - Differential voltage amplification as a function of frequency.

CA081, CA082, CA084

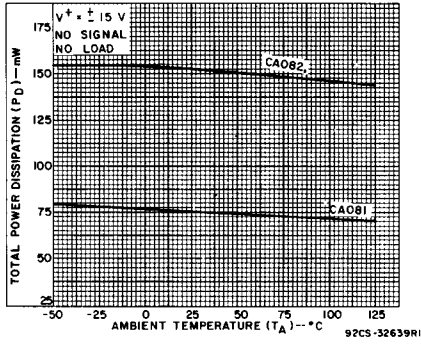

Fig. 11 - Total power dissipation as a function of ambient temperature.

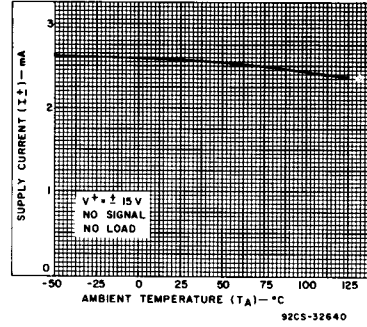

Fig. 12 - Supply current as a function of ambient temperature.

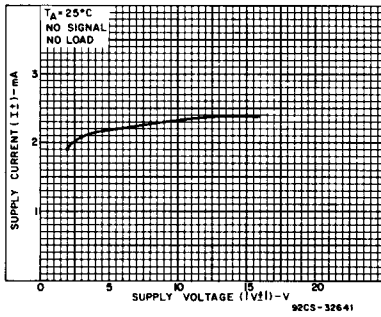

Fig. 13 - Supply current as a function of supply voltage.

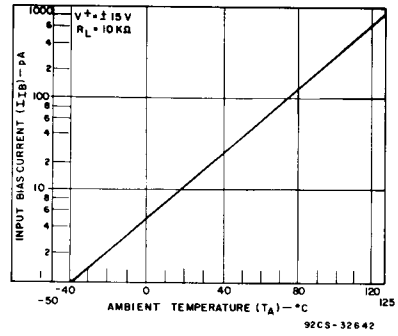

Fig. 14 - Input bias current as a function of ambient temperature.

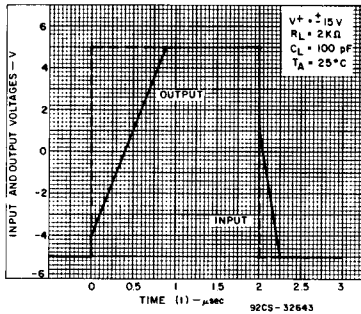

Fig. 15 - Voltage follower large-signal pulse response.

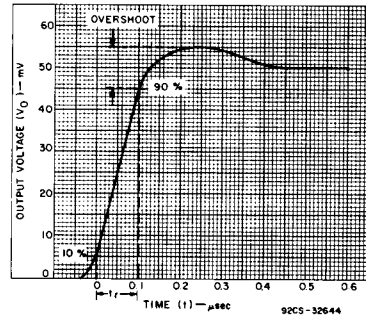
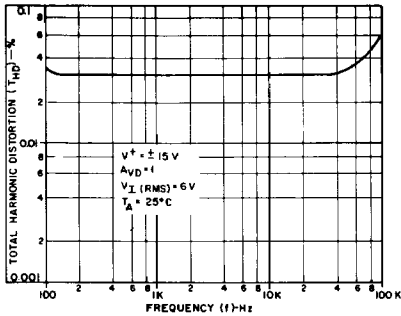

Fig. 16 - Output voltage as a function of elapsed time.

CA081, CA082, CA084



92CS-32645

Fig. 17 - Total harmonic distortion as a function of frequency.

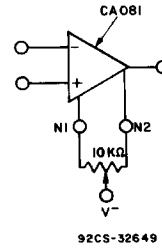

92CS-32649

Fig. 18 - Input offset voltage null circuit.

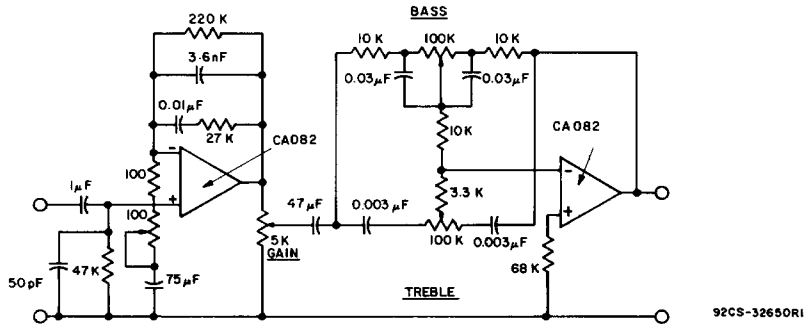

92CS-32650R1

Fig. 19 - IC preamplifier.

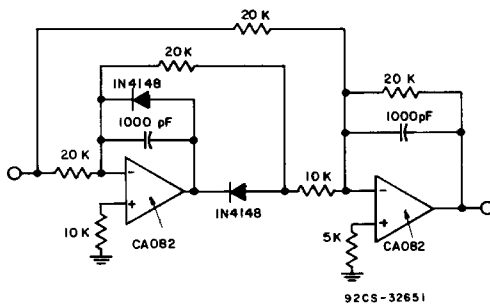

92CS-32651

Fig. 20 - Unity-gain absolute-value amplifier.

CURRENT AMPLIFIER

The low input-terminal current needed to drive the CA081 makes it ideal for use in current-amplifier applications such as the one shown in Fig. 21. In this circuit, low current is supplied at the input potential as the power supply to load resistor R_L . This load current is increased by the multiplication factor R_2/R_1 , when the load current is monitored by the power supply meter M. Thus, if the load current is 100 nA, with values shown, the load current presented to the supply will be 100 μ A; a much easier current to measure in many systems.

Note that the input and output voltages are transferred at the same potential and only the output current is multiplied by the scale factor.

The dotted components show a method of decoupling the circuit from the effects of high output-load capacitance and the potential oscillation in this situation. Essentially, the necessary high-frequency feedback is provided by the capacitor with the dotted series resistor providing load decoupling.

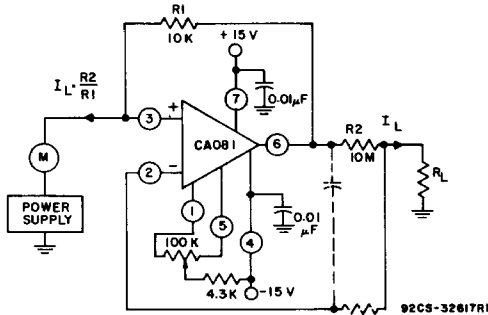

92CS-32617R1

Fig. 21 - Basic current amplifier for low-current measurement systems.