



Part Number: D3I1530

Electrical Specifications

Frequency Range (GHz):	1.5 – 3.0
Isolation (dB):	16 MIN
Insertion Loss (dB):	0.7 MAX
VSWR:	1.4:1 MIN
Forward Power (W):	30 AVG 40 PK
Reflective Power (W):	2 AVG

Mechanical/Environmental Specifications

Connector Type:	SMA
Connector Body:	Passivated stainless steel
Connector Pin:	Gold plated copper
Load Body:	Brass
Magnetic Shunt:	Nickel plated CRS
Operational Temp:	-20°C to +65°C
Weight (oz)	6.0 MAX

D3I1530 Dimensions

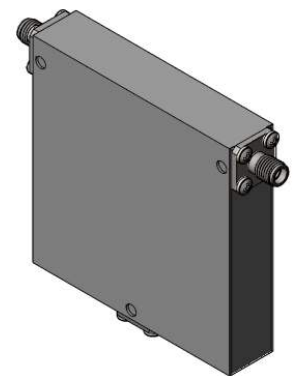
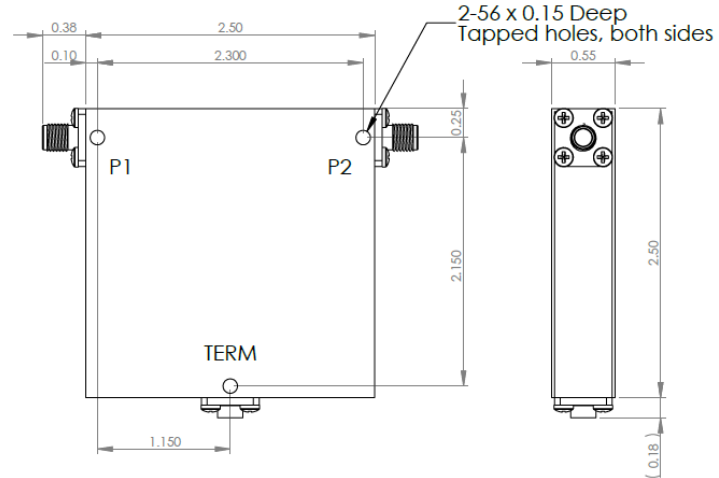

D3I1530-3 Dimensions

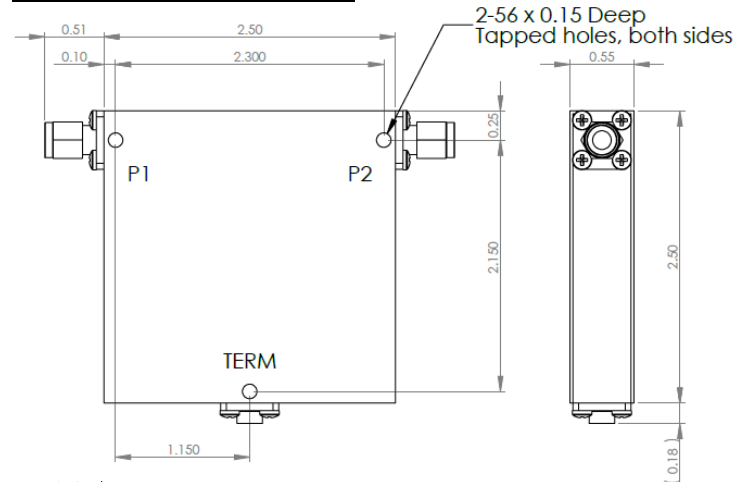

Dimensions are in inches
Tolerance

XX ±0.03
XXX ±0.010

Type of Device	PN Suffix	Connector Configuration Input / Output	PN Example
Single and Dual Junction Isolator, 2-Port Device Input / Output	N/A	Female / Female	D3I1530
	-1	Male / Female	D3I1530-1
	-2	Female / Male	D3I1530-2
	-3	Male / Male	D3I1530-3



MEASURED DATA

Part Number: D3I1530, +25°C

