

PART NUMBER SYSTEM

W 5 X 8 X - X PG -P- 3 XX

- 15 - CABLE OD 0.15 - 0.17 [3.8 - 4.3mm]
- 18 - CABLE OD 0.18 - 0.20 [4.6 - 5.1mm]
- 21 - CABLE OD 0.21 - 0.23 [5.3 - 5.8mm]
- 24 - CABLE OD 0.24 - 0.27 [6.1 - 6.8mm]
- 28 - CABLE OD 0.28 - 0.29 [7.1 - 7.4mm]
- 30 - CABLE OD 0.30 - 0.32 [7.6 - 8.1mm]

NOTES:

1. ALL PARTS TO BE BULK PACKED UNLESS NOTED.
2. INSTA CLICK IN LINE CABLE ASSEMBLY IS SUPPLIED AS A KIT. CONTACTS SUPPLIED UNASSEMBLED FOR CRIMP AND ASSEMBLED FOR SOCKET VERSIONS
3. ALL DIMENSIONS ARE REFERENCED IN INCHES [MM], WITHIN ± 0.015 UNLESS NOTED.
4. SIZE #12, 3 POSITION CRIMP CONTACTS ASSEMBLY IS BEEN SHOWN AS EXAMPLE. VISIT PART NUMBERING SYSTEM CHART TO VISIT VARIOUS SELECTIONS

CONTACT SIZES

- 1' - SIZE #12
- 2' - SIZE #20
- 3' - SIZE #16

CONTACTS STYLE

- 0' - CRIMP
- 2' - SOLDER

CONTACT POSITIONS

- POSITION 2, 3 & 4 (AVAILABLE IN SIZE #12)
- POSITION 4, 5 & 6 (AVAILABLE IN SIZE #16)
- POSITION 4,5,6,7,8,9,10,11&12 (AVAILABLE IN SIZE #20)

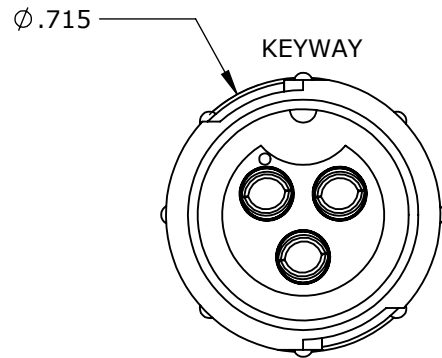

W5182-3SG-P-3XX SHOWN MATING VIEW

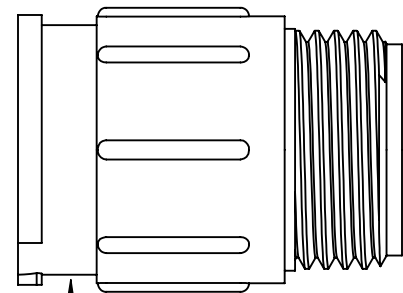

IN LINE CABLE CONN, MALE
MATL: THERMOPLASTIC, BLACK

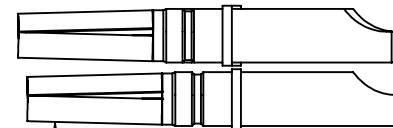

#12 SOLDER CONTACTS SHOWN HERE
MATL: COPPER ALLOY, GOLD PLATED

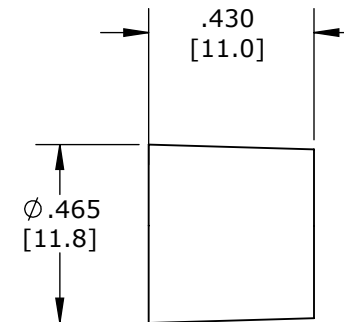

GROMMET
MATL: SANTOPRENE, BLACK

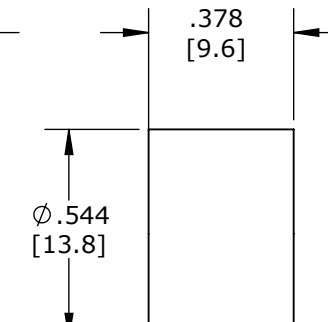

SLEEVE
MATL: THERMOPLASTIC, BLACK

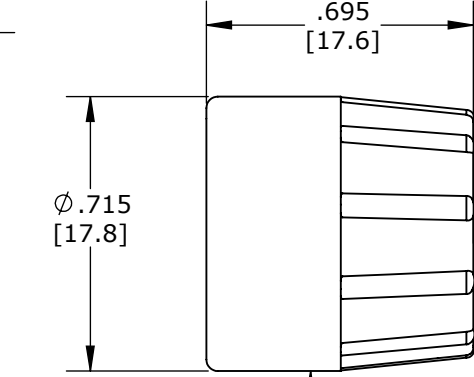

BACKSHELL
MATL: THERMOPLASTIC, BLACK

- W5182-XSG-P-315 0.156 ID FOR CABLES 0.15 - 0.17 [3.5 - 4.3mm]OD
- W5182-XSG-P-318 0.187 ID FOR CABLES 0.18 - 0.20 [4.6 - 5.1mm]OD
- W5182-XSG-P-321 0.225 ID FOR CABLES 0.21 - 0.23 [5.3 - 5.8mm]OD
- W5182-XSG-P-324 0.250 ID FOR CABLES 0.24 - 0.27 [6.1 - 6.8mm]OD
- W5182-XSG-P-328 0.285 ID FOR CABLES 0.28 - 0.29 [7.1 - 7.4mm]OD
- W5182-XSG-P-330 0.312 ID FOR CABLES 0.30 - 0.32 [7.6 - 8.1mm]OD

CUSTOMER DRAWING

PART NUMBER: W5X8X-XSG-P-3XX

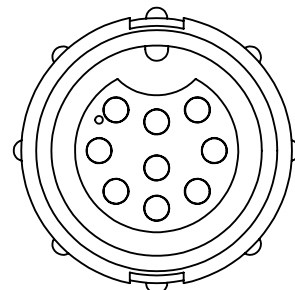

W5282-9SG-P-3XX MATING VIEW

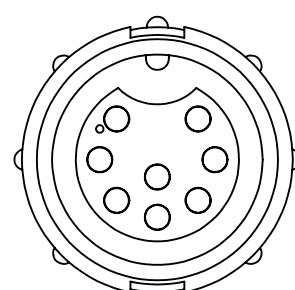

W5282-8SG-P-3XX MATING VIEW

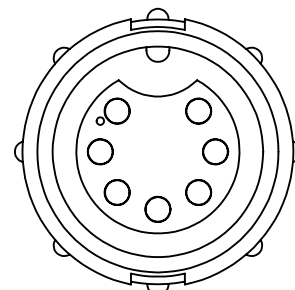

W5282-7SG-P-3XX MATING VIEW

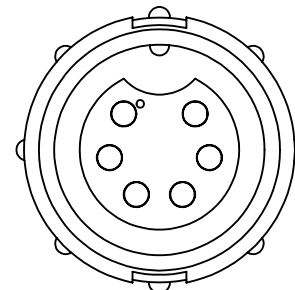

W5282-6SG-P-3XX MATING VIEW

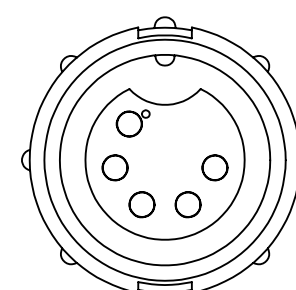

W5282-5SG-P-3XX MATING VIEW

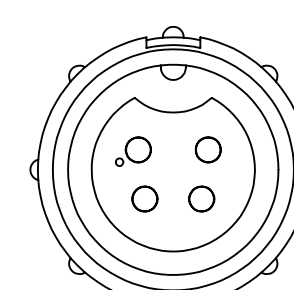

W5282-4SG-P-3XX MATING VIEW

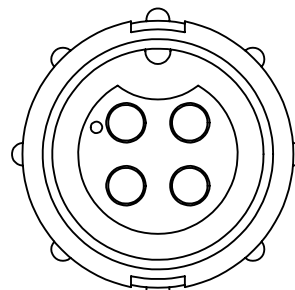

W5382-4SG-P-3XX MATING VIEW

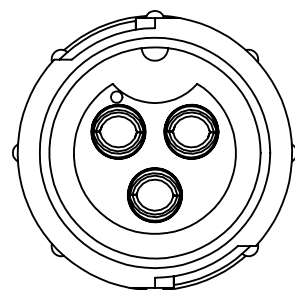

W5182-3SG-P-3XX MATING VIEW

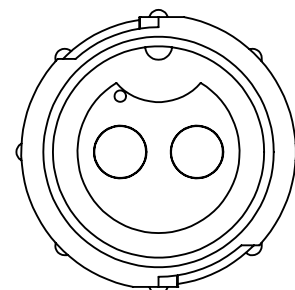

W5182-2SG-P-3XX MATING VIEW

0A	AM	03/29/22	CUSTOMER DRAWING
REV.	INIT.	DATE	DESCRIPTION
	AM	03/29/22	ORIG. DRAWN BY: DATE: AM 03/29/22
ALL INFORMATION ILLUSTRATED IS THE PROPERTY OF CONXALL CORPORATION. UNAUTHORIZED DUPLICATION OR DISTRIBUTION OF THIS DOCUMENT IS PROHIBITED.			<p>601 E. WILDWOOD VILLA PARK, IL 60181</p>
ALL UNITS ARE IN FEET, INCHES, FRACTION OF INCHES AND DECIMALS. UNLESS OTHERWISE SPECIFIED TOLERANCES: 3 PLACE DECIMALS ±.005 ANGLES ±1° FRACTIONS ±1/16			
APPROVED BY:		SCALE	TITLE: IN LINE CABLE CONNECTOR (2-4) #12, (4-6) #16, (4-12) #20 SKT CONTACTS MULTI CONX INSTA-CLICK STANDARD PRODUCT
FILE:		SIZE	CUSTOMER:
FILE NAME		B	W5X8X-XSG-P-3XX
DIRECTORY:		SHEET	REV
SLW		1 OF 1	0A