



Part Number: D3I5771

Electrical Specifications

Frequency Range (GHz):	5.7 - 7.1
Isolation (dB):	18 MIN
Insertion Loss (dB):	0.5 MAX
VSWR:	1.3:1 MIN
Forward Power (W):	20 AVG 30 PK
Reflective Power (W):	2 AVG

Mechanical/Environmental Specifications

Connector Type:	SMA
Connector Body:	Passivated stainless steel
Connector Pin:	Gold plated copper
Load Body:	Brass
Magnetic Shunt:	Nickel plated CRS
Operational Temp:	-30°C to +65°C
Weight (oz)	1.0 MAX

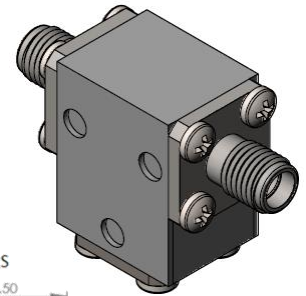

D3I5771 Dimensions

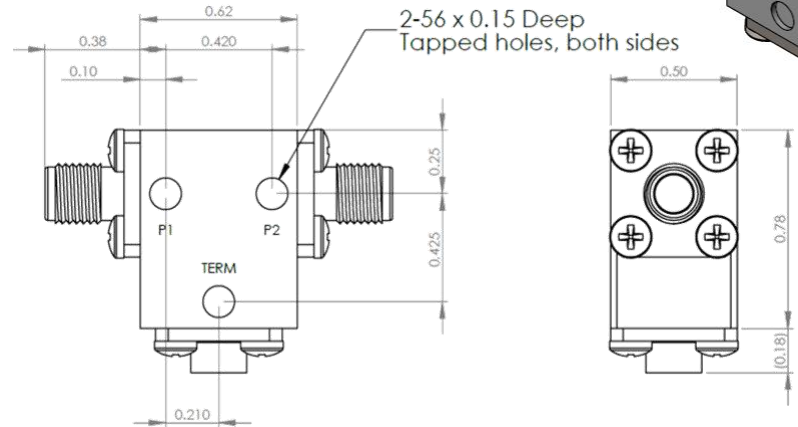

D3I5771-3 Dimensions

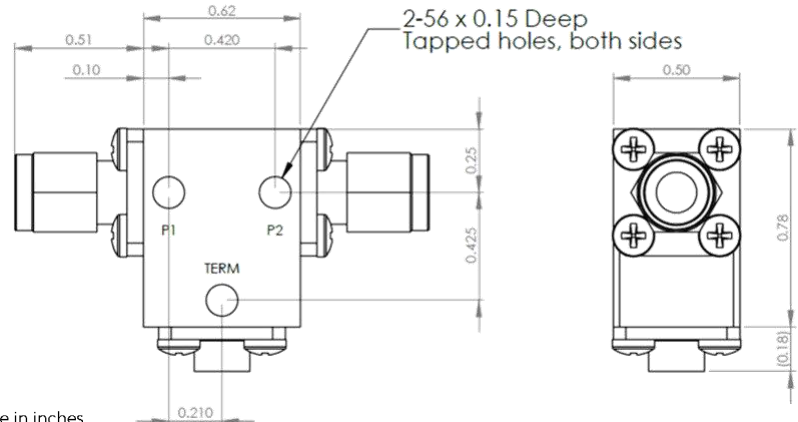

Dimensions are in inches
Tolerance

XX	±0.03
XXX	±0.010

Type of Device	PN Suffix	Connector Configuration Input / Output	PN Example
Single and Dual Junction Isolator, 2-Port Device Input / Output	N/A	Female / Female	D3I5771
	-1	Male / Female	D3I5771-1
	-2	Female / Male	D3I5771-2
	-3	Male / Male	D3I5771-3



MEASURED DATA

Part Number: D3I5771, +25°C

