

### General information

Part number	K21LAC-P04LJG0-320S
Termination	solder
Size	1
Locking principle	break , push
Coding	a_key
Cable Diameter	cable_mini_32
Cable outlet	bend_relief

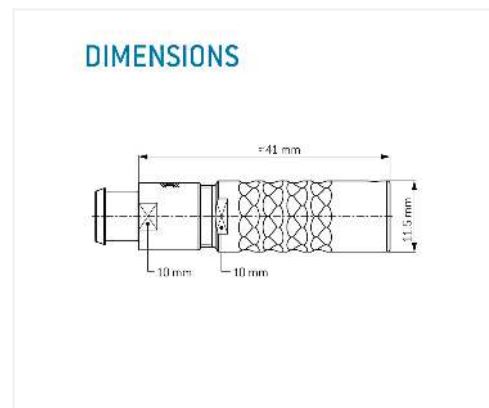
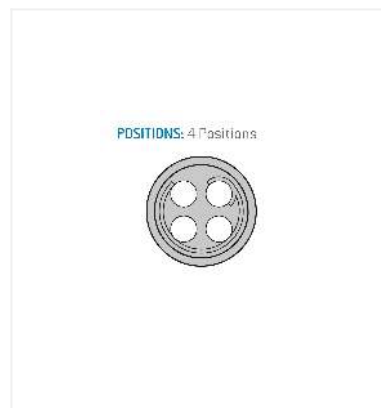

### Contact insert description

Number of contacts	4
Contact type	sockets
Contact diameter	09mm
Insulator material	peek
Wire cross section	22_awg
Termination	solder
Termination diameter	085mm
Data transmission	ethernet_100

reverse\_gender\_on\_request

### Technical information

Max. creepage and air clearance distance	10_mm	14_mm
Nominal current single contact	075_a	iec_60512_5_2
Nominal current insert	7,5 A	vde_0298_4
Test voltage	15_kv_ac	sae_13441

safety\_text

## Mechanical and environmental data

Degree of protection*	ip50
Operating temperature	40_120_c
Mating cycles	5000

mated\_unmated

## Material and surface treatments

Housing	m_chrome
Contact	cu_alloy_gold

data\_text

safety\_text\_2

data\_text

ul\_text

illustrative\_text