

THIS DRAWING IS UNPUBLISHED.

RELEASED FOR PUBLICATION

© COPYRIGHT - BY TYCO ELECTRONICS CORPORATION.

ALL INTERNATIONAL RIGHTS RESERVED.

LOC		DIST		REVISIONS			
P	LTR	DESCRIPTION		DATE	DWN	APVD	
	B	ECR-18-009924		27JUN18	MG	BM	

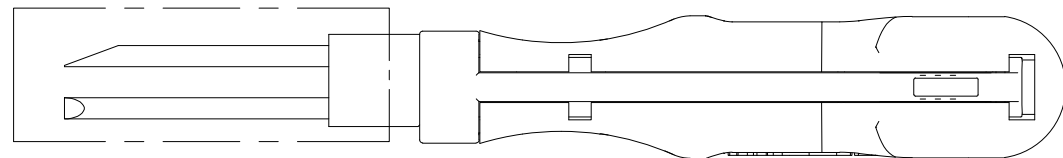
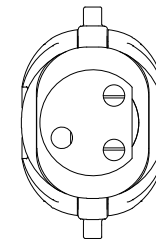
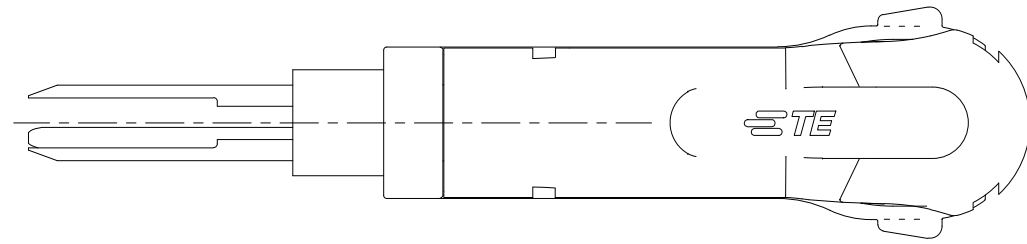

A

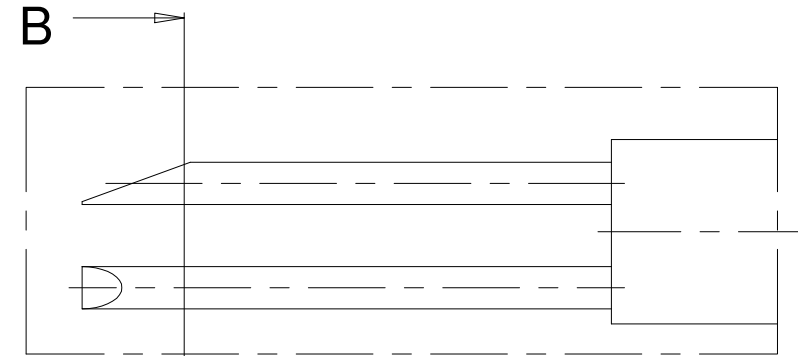

A
2:1

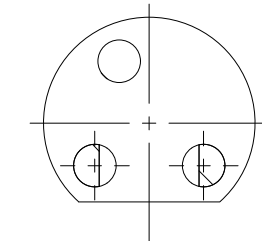

B-B

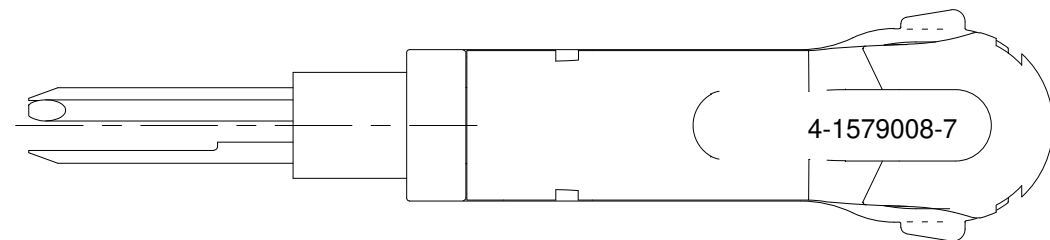

4-1579008-7

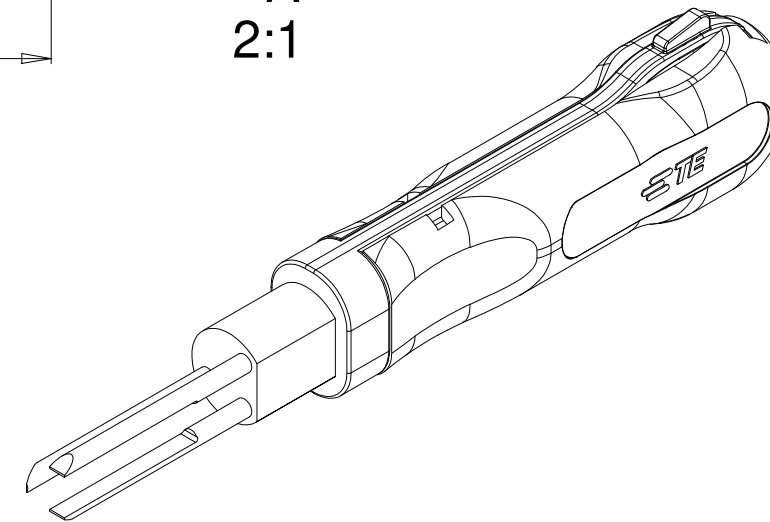

FOR CONTACTS / HOUSINGS:

MPT (in relay holder)

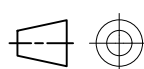
THIS DRAWING IS A CONTROLLED DOCUMENT.		DWN	06.11.2006		 TE Connectivity	
DIMENSIONS: mm		CHK	-			
TOLERANCES UNLESS OTHERWISE SPECIFIED:		APVD	-		NAME	
		PRODUCT SPEC	-		EXTRACTION TOOL	
0 PLC ± -		APPLICATION SPEC	-		Entriegelungswerkzeug	
1 PLC ± -		SIZE	CAGE CODE	DRAWING NO	RESTRICTED TO	
2 PLC ± -		WEIGHT	00779	C-4-1579008-7	-	
3 PLC ± -		CUSTOMER DRAWING		SCALE	SHEET	REV
4 PLC ± -				1:1	1 OF 1	B
ANGLES ± -						
FINISH						
MATERIAL						