

HLMP-CExx

T-1 3/4 (5mm) Extra Bright Cyan LEDs



Data Sheet



Lead (Pb) Free
RoHS 6 fully
compliant



Description

The high intensity Cyan LEDs are based on the most efficient and cost effective InGaN material technology. The 505nm typical dominant wavelength is most suitable for traffic signal application. These LED lamps are untinted, non-diffused, T-1 3/4 packages incorporating second generation optics which produce well-defined spatial radiation patterns at specific viewing cone angles.

These lamps are made with an advanced optical grade epoxy, offering superior temperature and moisture resistance in outdoor sign and signals applications.

Features

- Viewing Angle: 15°, 23° and 30°
- Well defined spatial radiation pattern
- High brightness material
- Superior resistance to moisture
- Package options:
 - Stand-off and Non Stand-off Leads
- Untinted and non diffused

Applications

- Traffic signals

Package Dimensions

A: Non stand-off

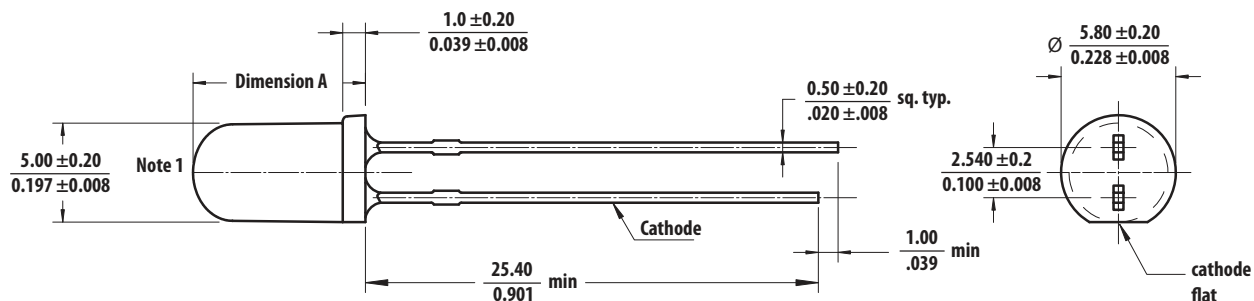

B: Stand-off

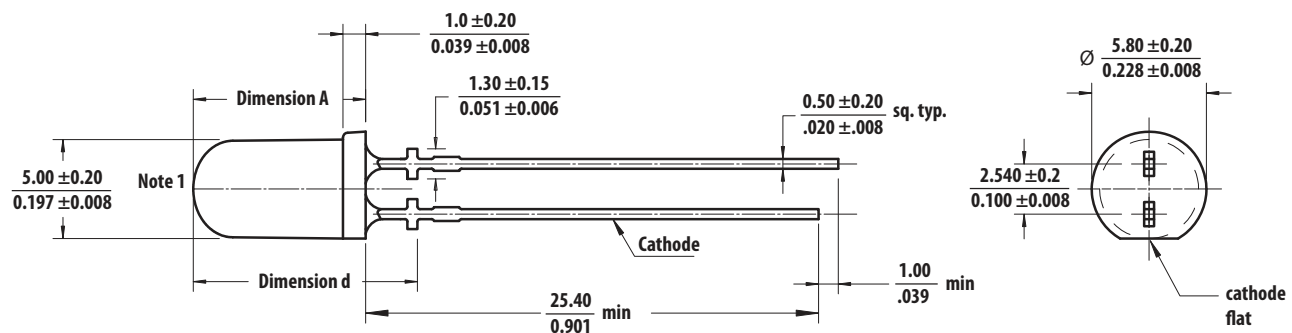

Package	Dimension A	Dimension d
15°	8.70 ± 0.20 mm	13.00 ± 0.20 mm
23°	8.65 ± 0.20 mm	12.25 ± 0.20 mm
30°	8.65 ± 0.20 mm	12.05 ± 0.20 mm

Notes:

1. Measured above flange.
2. All dimensions in millimeters (inches).

CAUTION: InGaN devices are Class 1C HBM ESD sensitive per JEDEC Standard. Please observe appropriate precautions during handling and processing. Refer to Application Note AN-1142 for additional details.

Device Selection Guide

Part Number	Luminous Intensity Iv (mcd) at 20 mA Min.	Luminous Intensity Iv (mcd) at 20 mA Max.	Stand-Off
HLMP-CE13-35CDD	27000	59000	No
HLMP-CE13-35QDD	27000	59000	No
HLMP-CE22-Z2CDD	12000	27000	No
HLMP-CE22-Z2QDD	12000	27000	No
HLMP-CE34-Y1CDD	9300	21000	No
HLMP-CE34-Y1QDD	9300	21000	No
HLMP-CE14-35CDD	27000	59000	Yes
HLMP-CE14-35QDD	27000	59000	Yes
HLMP-CE25-Z2CDD	12000	27000	Yes
HLMP-CE25-Z2QDD	12000	27000	Yes
HLMP-CE35-Y1CDD	9300	21000	Yes
HLMP-CE35-Y1QDD	9300	21000	Yes

Tolerance for each intensity limit is $\pm 15\%$.

Notes:

1. The luminous intensity is measured on the mechanical axis of the lamp package.
2. Tolerance for each intensity limit is $\pm 15\%$.
3. Please refer to AN 5352 for detail information on features of stand-off and non stand-off LEDs.

Part Numbering System

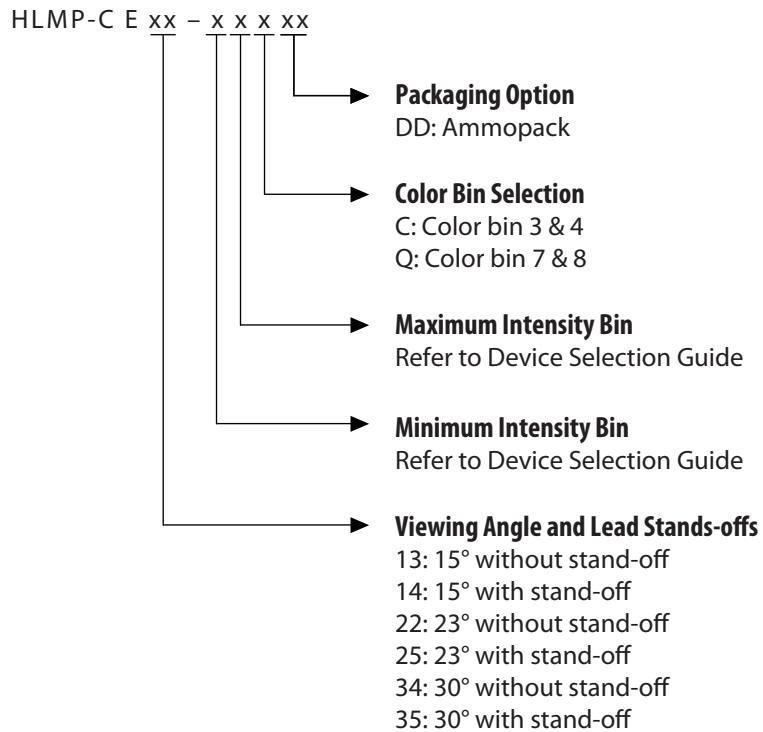

Note:

Please refer to AB 5337 for complete information about part numbering system.

Absolute Maximum Ratings

$T_J = 25^\circ\text{C}$

Parameter	Value	Unit
DC Forward Current ^[1]	30	mA
Peak Forward Current	100 ^[2]	mA
Power Dissipation	107	mW
Reverse Voltage	Not recommended for reverse bias	
Operating Temperature Range	-40 to +85	°C
Storage Temperature Range	-40 to +85	°C

Notes:

1. Derate linearly as shown in Figure 5.
2. Duty Factor 10%, frequency 1KHz.

Electrical / Optical Characteristics

$T_A = 25^\circ\text{C}$

Parameter	Symbol	Min.	Typ.	Max.	Units	Test Conditions
Forward Voltage	V_F	2.8	3.2	3.5	V	$I_F = 20\text{ mA}$
Dominant Wavelength ^[1]	λ_d		505		nm	$I_F = 20\text{ mA}$
Peak Wavelength	λ_{PEAK}		501		nm	Peak of Wavelength of Spectral Distribution at $I_F = 20\text{ mA}$
Spectral Halfwidth	$\Delta\lambda_{1/2}$		30			Wavelength width at spectral distribution 1/2 power point at $I_F = 20\text{ mA}$
Thermal Resistance	$R\theta_{J-PIN}$		240		°C/W	LED Junction-to-Cathode Lead
Luminous Efficacy ^[2]	η_V		326		lm/W	Emitted Luminous Power/Emitted Radiant Power
Luminous Flux	ϕ_V		2.1		lm	$I_F = 20\text{ mA}$
Luminous Efficiency ^[3]	η_e		34		lm/W	Emitted Luminous Flux/Electrical Power

Notes:

1. The dominant wavelength is derived from the chromaticity Diagram and represents the color of the lamp. Tolerance for each color of dominant wavelength is $\pm 0.5\text{nm}$.
2. The radiant intensity, I_e in watts per steradian, may be found from the equation $I_e = I_V/\eta_V$ where I_V is the luminous intensity in candelas and η_V is the luminous efficacy in lumens/watt.
3. $\eta_e = \phi_V / I_F \times V_F$ where ϕ_V is the emitted luminous flux, I_F is electrical forward current and V_F is the forward voltage.

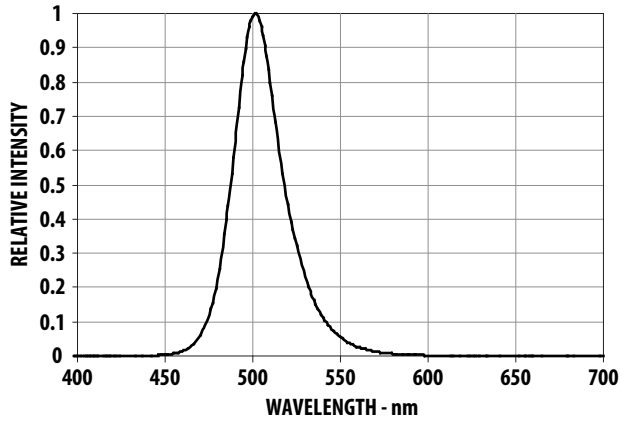

Figure 1. Relative Intensity vs Wavelength

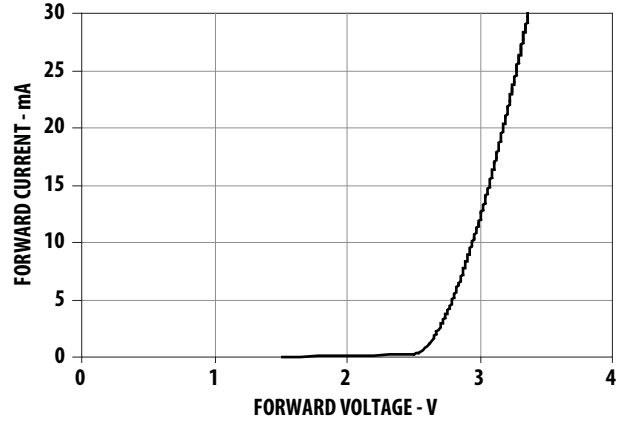

Figure 2. Forward Current vs Forward Voltage

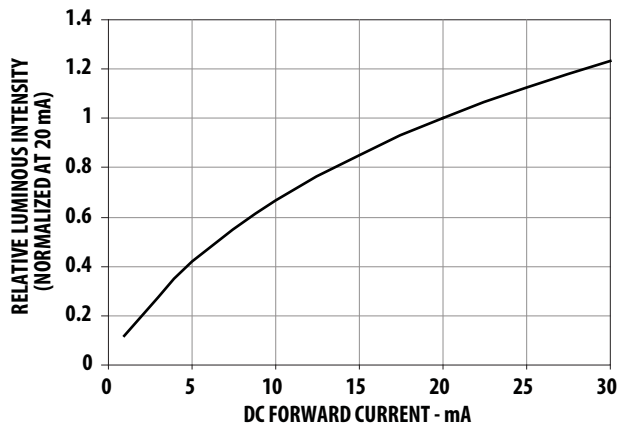

Figure 3. Relative Intensity vs Forward Current

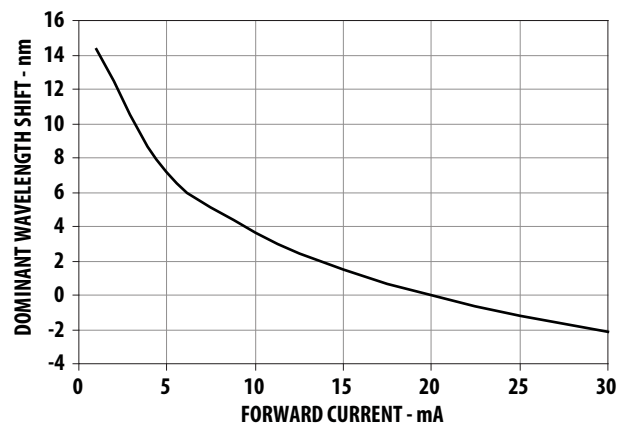

Figure 4. Relative Dominant Wavelength vs Forward Current

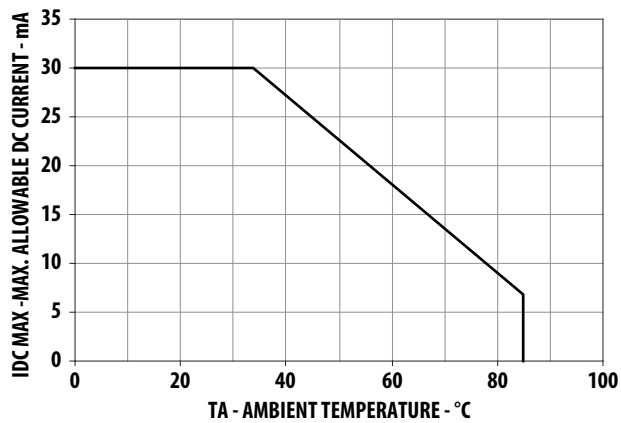

Figure 5. Maximum Forward Current vs Ambient Temperature

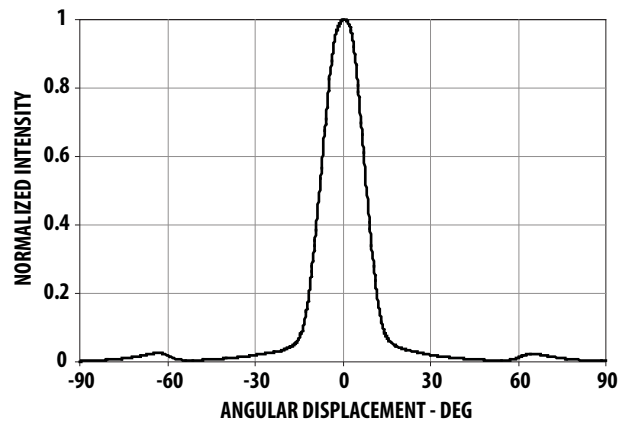

Figure 6. Representative Spatial Radiation Pattern – 15° Lamps

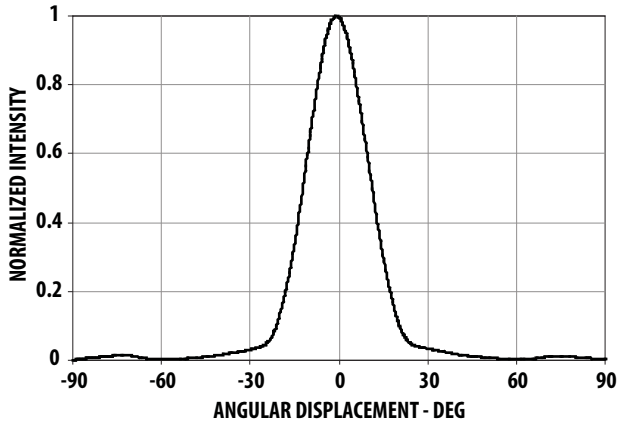

Figure 7. Representative Spatial Radiation Pattern – 23° Lamps

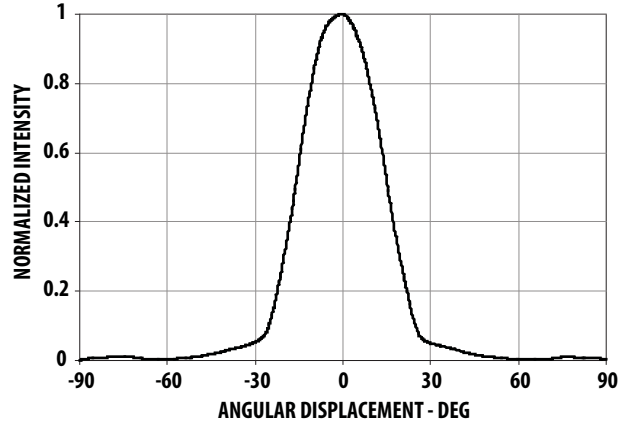
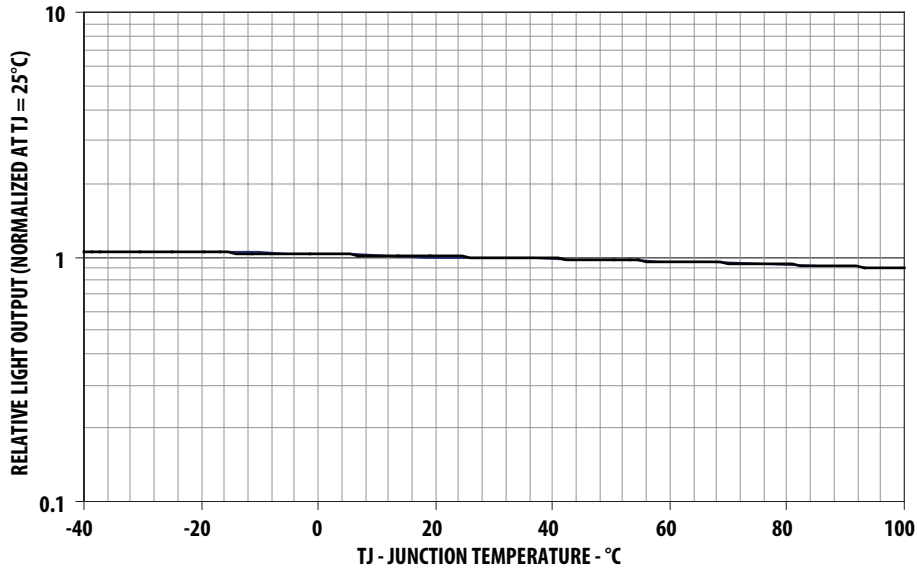

Figure 8. Representative Spatial Radiation Pattern – 30° Lamps

Relative Light Output vs Junction Temperature



Intensity Bin Limit Table (1.3: 1 Iv Bin Ratio)

Bin	Intensity (mcd) at 20 mA	
	Min	Max
Y	9300	12000
Z	12000	16000
1	16000	21000
2	21000	27000
3	27000	35000
4	35000	45000
5	45000	59000

Tolerance for each bin limit is $\pm 15\%$

Cyan Color Bin Limits

Bin	Min	Max
3	500	505
4	505	510
7	498	503
8	503	508

Tolerance for each bin limit is $\pm 0.5\text{nm}$.

Precautions:

Lead Forming:

- The leads of an LED lamp may be preformed or cut to length prior to insertion and soldering on PC board.
- For better control, it is recommended to use proper tool to precisely form and cut the leads to applicable length rather than doing it manually.
- If manual lead cutting is necessary, cut the leads after the soldering process. The solder connection forms a mechanical ground which prevents mechanical stress due to lead cutting from traveling into LED package. This is highly recommended for hand solder operation, as the excess lead length also acts as small heat sink.

Soldering and Handling:

- Care must be taken during PCB assembly and soldering process to prevent damage to the LED component.
- LED component may be effectively hand soldered to PCB. However, it is only recommended under unavoidable circumstances such as rework. The closest manual soldering distance of the soldering heat source (soldering iron's tip) to the body is 1.59mm. Soldering the LED using soldering iron tip closer than 1.59mm might damage the LED.

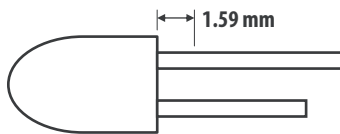

- ESD precaution must be properly applied on the soldering station and personnel to prevent ESD damage to the LED component that is ESD sensitive. Do refer to Avago application note AN 1142 for details. The soldering iron used should have grounded tip to ensure electrostatic charge is properly grounded.
- Recommended soldering condition:

	Wave Soldering [1, 2]	Manual Solder Dipping
Pre-heat temperature	105°C Max.	-
Preheat time	60 sec Max	-
Peak temperature	260°C Max.	260°C Max.
Dwell time	5 sec Max.	5 sec Max

Note:

- 1) Above conditions refers to measurement with thermocouple mounted at the bottom of PCB.
- 2) It is recommended to use only bottom preheaters in order to reduce thermal stress experienced by LED.

- Wave soldering parameters must be set and maintained according to the recommended temperature and dwell time. Customer is advised to perform daily check on the soldering profile to ensure that it is always conforming to recommended soldering conditions.

Note:

1. PCB with different size and design (component density) will have different heat mass (heat capacity). This might cause a change in temperature experienced by the board if same wave soldering setting is used. So, it is recommended to re-calibrate the soldering profile again before loading a new type of PCB.
2. Customer is advised to take extra precaution during wave soldering to ensure that the maximum wave temperature does not exceed 260°C and the solder contact time does not exceeding 5sec. Over-stressing the LED during soldering process might cause premature failure to the LED due to delamination.

Avago Technologies LED Configuration

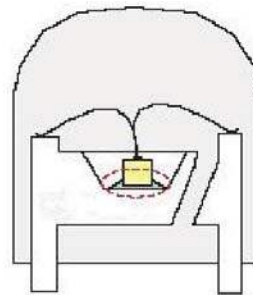

- Any alignment fixture that is being applied during wave soldering should be loosely fitted and should not apply weight or force on LED. Non metal material is recommended as it will absorb less heat during wave soldering process.
- At elevated temperature, LED is more susceptible to mechanical stress. Therefore, PCB must allowed to cool down to room temperature prior to handling, which includes removal of alignment fixture or pallet.
- If PCB board contains both through hole (TH) LED and other surface mount components, it is recommended that surface mount components be soldered on the top side of the PCB. If surface mount need to be on the bottom side, these components should be soldered using reflow soldering prior to insertion the TH LED.
- Recommended PC board plated through holes (PTH) size for LED component leads.

LED component lead size	Diagonal	Plated through hole diameter
0.45 x 0.45 mm (0.018x 0.018 inch)	0.636 mm (0.025 inch)	0.98 to 1.08 mm (0.039 to 0.043 inch)
0.50 x 0.50 mm (0.020x 0.020 inch)	0.707 mm (0.028 inch)	1.05 to 1.15 mm (0.041 to 0.045 inch)

- Over-sizing the PTH can lead to twisted LED after clinching. On the other hand under sizing the PTH can cause difficulty inserting the TH LED.

Refer to application note AN5334 for more information about soldering and handling of high brightness TH LED lamps.

Example of Wave Soldering Temperature Profile for TH LED

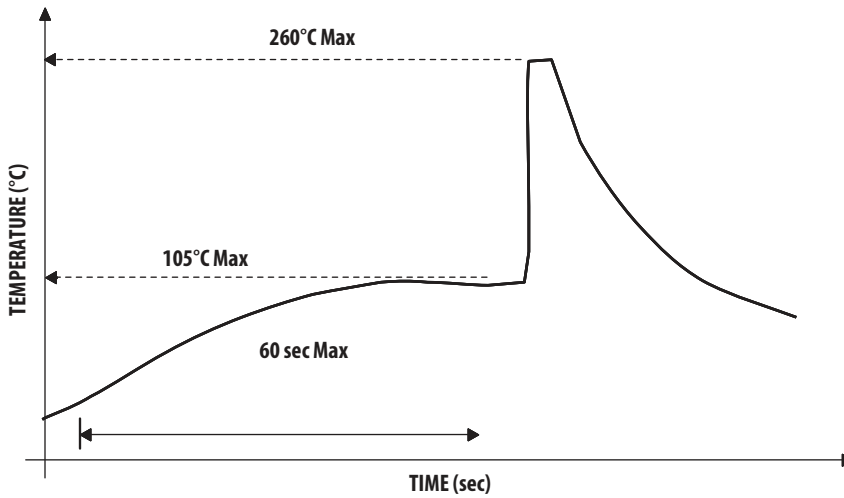

Recommended solder:
 Sn63 (Leaded solder alloy)
 SAC305 (Lead free solder alloy)

Flux: Rosin flux

Solder bath temperature: 255°C ± 5°C
 (maximum peak temperature = 260°C)

Dwell time: 3 sec - 5 sec
 (maximum = 5 sec)

Note: Allow for board to be sufficiently cooled to room temperature before exerting mechanical force.

Ammo Packs Drawing

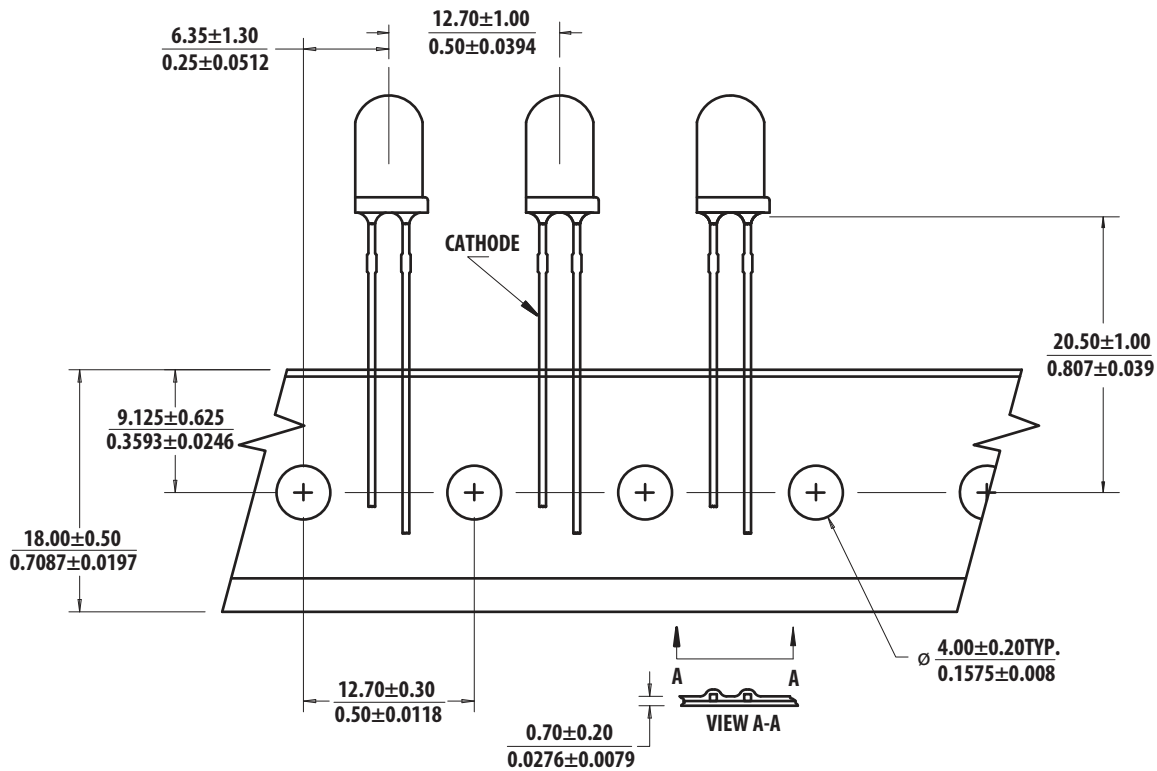

Note: All dimensions are in millimeters (inches).

Packaging Box for Ammo Packs

FROM LEFT SIDE OF BOX
ADHESIVE TAPE MUST BE
FACING UPWARDS.

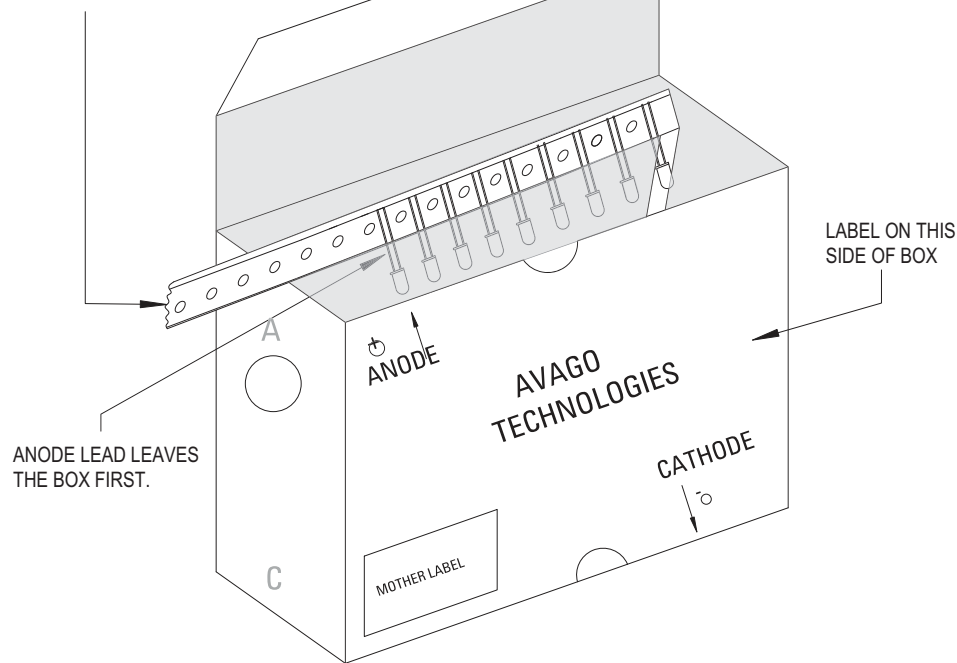











Note: The dimension for ammo pack is applicable for the device with standoff and without standoff.

Packaging Label:

(i) Avago Mother Label: (Available on packaging box of ammo pack and shipping box)

 Avago TECHNOLOGIES	
(1P) Item: <u>Part Number</u>	STANDARD LABEL LS0002
	RoHS Compliant
(1T) Lot: <u>Lot Number</u>	e3 max temp 260C
	(Q) QTY: <u>Quantity</u>
LPN:	
	CAT: <u>Intensity Bin</u>
(9D)MFG Date: <u>Manufacturing Date</u>	
	BIN: <u>Color Bin</u>
<hr/>	
(P) Customer Item:	
(V) Vendor ID:	(9D) Date Code: <u>Date Code</u>
<hr/>	
DeptID:	Made In: <u>Country of Origin</u>

(ii) Avago Baby Label (Only available on bulk packaging)

 Lamps Baby Label		RoHS Compliant e3 max temp 260C
(1P) PART #: Part Number 		
(1T) LOT #: Lot Number 		
(9D)MFG DATE: Manufacturing Date 	QUANTITY: Packing Quantity 	
C/O: Country of Origin		
Customer P/N: 	CAT: Intensity Bin 	
Supplier Code: 	BIN: Color Bin 	
	DATECODE: Date Code 	

DISCLAIMER: Avago's products and software are not specifically designed, manufactured or authorized for sale as parts, components or assemblies for the planning, construction, maintenance or direct operation of a nuclear facility or for use in medical devices or applications. Customer is solely responsible, and waives all rights to make claims against avago or its suppliers, fo all loss, damage, expense or liability in connection with such use.

For product information and a complete list of distributors, please go to our web site: www.avagotech.com

Avago, Avago Technologies, and the A logo are trademarks of Avago Technologies in the United States and other countries. Data subject to change. Copyright © 2005-2010 Avago Technologies. All rights reserved.
AV02-1823EN - January 20, 2010

