

PHP/PHU66NQ03LT

N-channel TrenchMOS™ logic level FET

Rev. 06 — 12 August 2004

Product data sheet

1. Product profile

1.1 General description

Logic level N-channel enhancement mode field effect transistor in a plastic package using TrenchMOS™ technology.

1.2 Features

- Logic level threshold
- Low on-state resistance.

1.3 Applications

- DC-to-DC converters
- General purpose switching.

1.4 Quick reference data

- $V_{DS} \leq 25$ V
- $I_D \leq 66$ A
- $R_{DSon} \leq 10.5$ m Ω
- $Q_{gd} = 3.6$ nC (typ).

2. Pinning information

Table 1: Discrete pinning

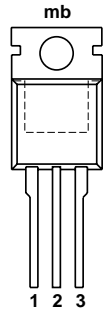
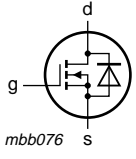
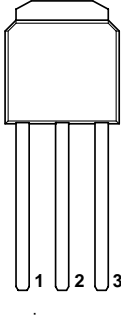
Pin	Description	Simplified outline	Symbol
1	gate (g)		
2	drain (d)		
3	source (s)		
mb	mounting base; connected to drain (d)		
			
		Top view	
		SOT78 (TO-220AB)	SOT533 (I-PAK)

PHILIPS

3. Ordering information

Table 2: Ordering information

Type number	Package		Version
	Name	Description	
PHP66NQ03LT	TO-220AB	Plastic single-ended package; heatsink mounted; 1 mounting hole; 3 lead TO-220AB	SOT78
PHU66NQ03LT	I-PAK	Plastic single-ended package (Philips version of I-PAK); 3 leads (in-line)	SOT533

4. Limiting values

Table 3: Limiting values

In accordance with the Absolute Maximum Rating System (IEC 60134).

Symbol	Parameter	Conditions	Min	Max	Unit
V_{DS}	drain-source voltage (DC)	$25\text{ °C} \leq T_j \leq 175\text{ °C}$	-	25	V
V_{DGR}	drain-gate voltage (DC)	$25\text{ °C} \leq T_j \leq 175\text{ °C}$; $R_{GS} = 20\text{ k}\Omega$	-	25	V
V_{GS}	gate-source voltage (DC)		-	± 20	V
I_D	drain current (DC)	$T_{mb} = 25\text{ °C}$; $V_{GS} = 5\text{ V}$; Figure 2 and 3	-	57	A
		$T_{mb} = 100\text{ °C}$; $V_{GS} = 5\text{ V}$; Figure 2	-	40	A
		$T_{mb} = 25\text{ °C}$; $V_{GS} = 10\text{ V}$	-	66	A
		$T_{mb} = 100\text{ °C}$; $V_{GS} = 10\text{ V}$	-	45	A
I_{DM}	peak drain current	$T_{mb} = 25\text{ °C}$; pulsed; $t_p \leq 10\text{ }\mu\text{s}$; Figure 3	-	228	A
P_{tot}	total power dissipation	$T_{mb} = 25\text{ °C}$; Figure 1	-	93	W
T_{stg}	storage temperature		-55	+175	°C
T_j	junction temperature		-55	+175	°C
Source-drain diode					
I_S	source (diode forward) current (DC)	$T_{mb} = 25\text{ °C}$	-	57	A
I_{SM}	peak source (diode forward) current	$T_{mb} = 25\text{ °C}$; pulsed; $t_p \leq 10\text{ }\mu\text{s}$	-	228	A
Avalanche ruggedness					
$E_{DS(AL)S}$	non-repetitive drain-source avalanche energy	unclamped inductive load; $I_D = 43\text{ A}$; $t_p = 0.15\text{ ms}$; $V_{DD} \leq 25\text{ V}$; $R_{GS} = 50\text{ }\Omega$; $V_{GS} = 10\text{ V}$; starting at $T_j = 25\text{ °C}$	-	90	mJ

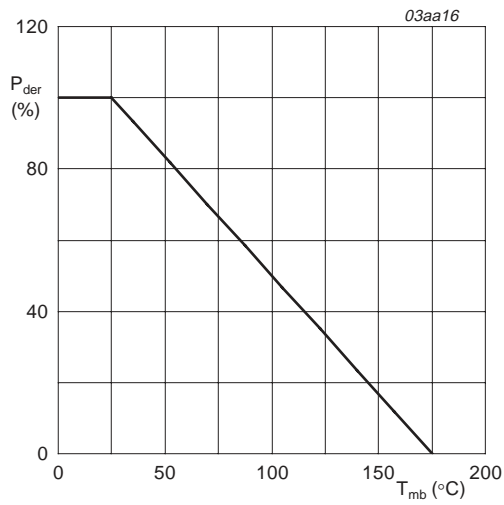

$$P_{der} = \frac{P_{tot}}{P_{tot(25^{\circ}C)}} \times 100\%$$

Fig 1. Normalized total power dissipation as a function of mounting base temperature.

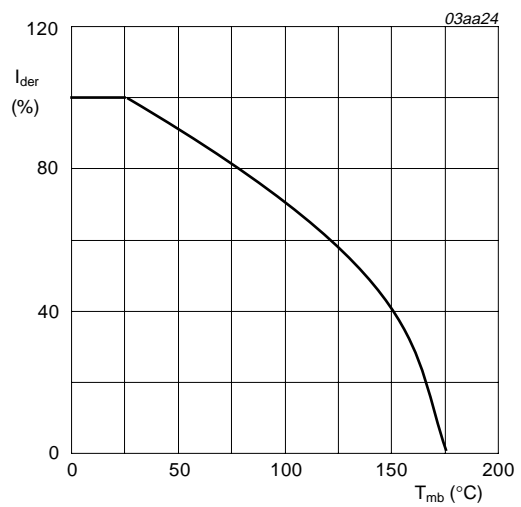

$$I_{der} = \frac{I_D}{I_{D(25^{\circ}C)}} \times 100\%$$

Fig 2. Normalized continuous drain current as a function of mounting base temperature.

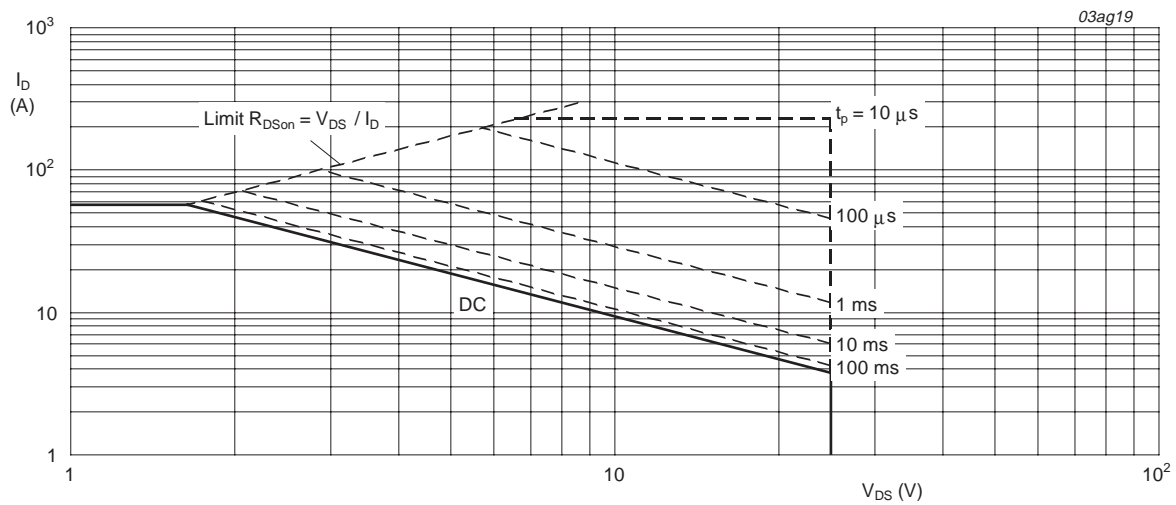

$T_{mb} = 25^{\circ}C$; I_{DM} is single pulse; $V_{GS} = 5 V$

Fig 3. Safe operating area; continuous and peak drain currents as a function of drain-source voltage.

5. Thermal characteristics

Table 4: Thermal characteristics

Symbol	Parameter	Conditions	Min	Typ	Max	Unit
$R_{th(j-mb)}$	thermal resistance from junction to mounting base	Figure 4	-	-	1.6	K/W
$R_{th(j-a)}$	thermal resistance from junction to ambient					
	SOT78	vertical in free air	-	60	-	K/W
	SOT533		-	70	-	K/W

5.1 Transient thermal impedance

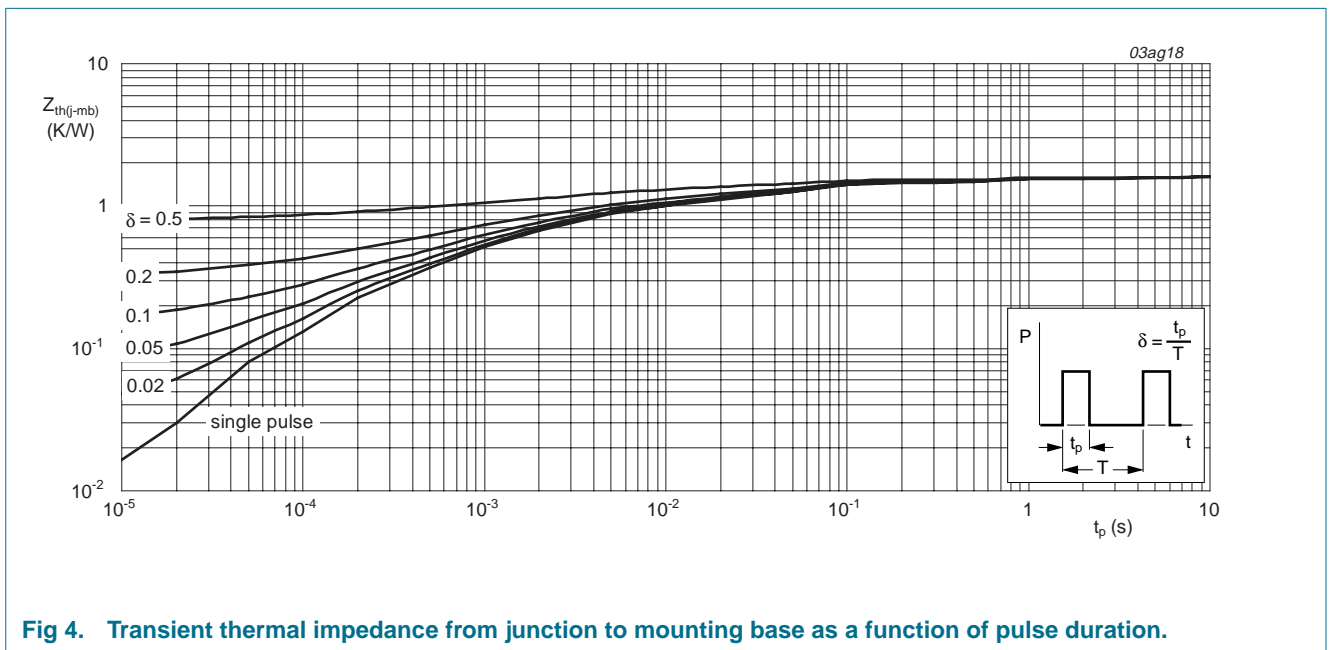
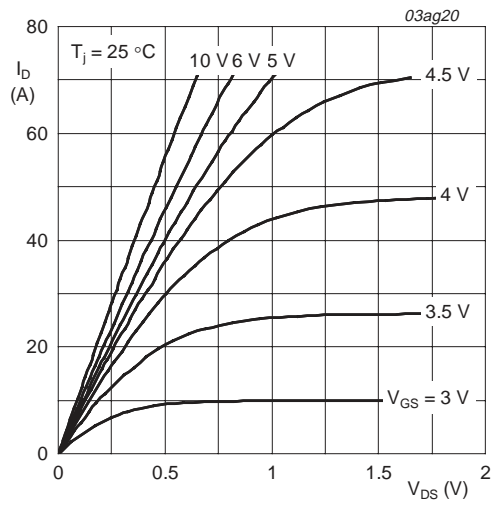

Fig 4. Transient thermal impedance from junction to mounting base as a function of pulse duration.

6. Characteristics

Table 5: Characteristics
T_j = 25 °C unless otherwise specified.

Symbol	Parameter	Conditions	Min	Typ	Max	Unit
Static characteristics						
V _{(BR)DSS}	drain-source breakdown voltage	I _D = 250 μA; V _{GS} = 0 V				
		T _j = 25 °C	25	-	-	V
		T _j = -55 °C	22	-	-	V
V _{GS(th)}	gate-source threshold voltage	I _D = 1 mA; V _{DS} = V _{GS} ; Figure 9 and 10				
		T _j = 25 °C	1	1.5	2	V
		T _j = 175 °C	0.5	-	-	V
		T _j = -55 °C	-	-	2.2	V
I _{DSS}	drain-source leakage current	V _{DS} = 25 V; V _{GS} = 0 V				
		T _j = 25 °C	-	-	10	μA
		T _j = 175 °C	-	-	500	μA
I _{GSS}	gate-source leakage current	V _{GS} = ±15 V; V _{DS} = 0 V	-	10	100	nA
R _{DS(on)}	drain-source on-state resistance	V _{GS} = 10 V; I _D = 25 A; Figure 6 and 8				
		T _j = 25 °C	-	9.1	10.5	mΩ
		T _j = 175 °C	-	16.4	18.9	mΩ
		V _{GS} = 5 V; I _D = 25 A; Figure 6 and 8	-	11.2	13.6	mΩ
Dynamic characteristics						
Q _{g(tot)}	total gate charge	I _D = 50 A; V _{DS} = 15 V; V _{GS} = 5 V; Figure 11	-	12	-	nC
Q _{gs}	gate-source charge		-	4.5	-	nC
Q _{gd}	gate-drain (Miller) charge		-	3.6	-	nC
C _{iss}	input capacitance	V _{GS} = 0 V; V _{DS} = 25 V; f = 1 MHz; Figure 13	-	860	-	pF
C _{oss}	output capacitance		-	330	-	pF
C _{rss}	reverse transfer capacitance		-	145	-	pF
t _{d(on)}	turn-on delay time	V _{DS} = 15 V; R _L = 0.6 Ω; V _{GS} = 5 V; R _G = 5.6 Ω	-	15	25	ns
t _r	rise time		-	90	135	ns
t _{d(off)}	turn-off delay time		-	25	40	ns
t _f	fall time		-	25	40	ns
Source-drain diode						
V _{SD}	source-drain (diode forward) voltage	I _S = 25 A; V _{GS} = 0 V; Figure 12	-	0.95	1.2	V
t _{rr}	reverse recovery time	I _S = 10 A; dI _S /dt = -100 A/μs;	-	32	-	ns
Q _r	recovered charge	V _{GS} = 0 V; V _R = 25 V	-	20	-	nC



$T_j = 25\text{ °C}$

Fig 5. Output characteristics: drain current as a function of drain-source voltage; typical values.

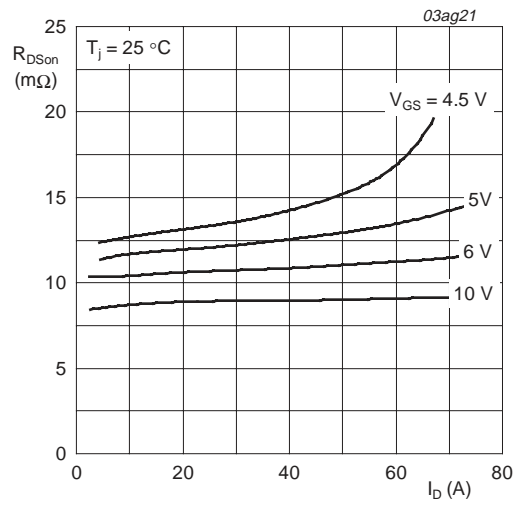

$T_j = 25\text{ °C}$

Fig 6. Drain-source on-state resistance as a function of drain current; typical values.

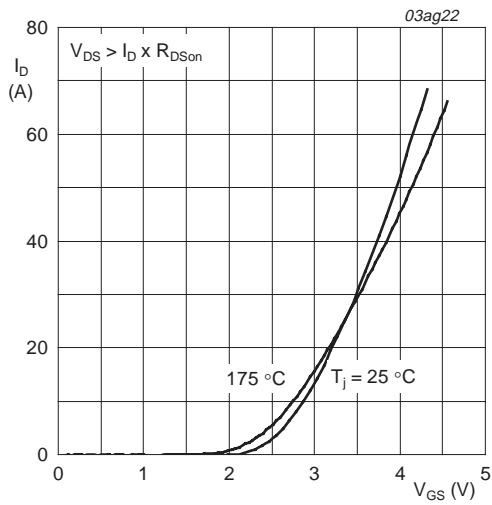

$T_j = 25\text{ °C and } 175\text{ °C}; V_{DS} > I_D \times R_{DS(on)}$

Fig 7. Transfer characteristics: drain current as a function of gate-source voltage; typical values.

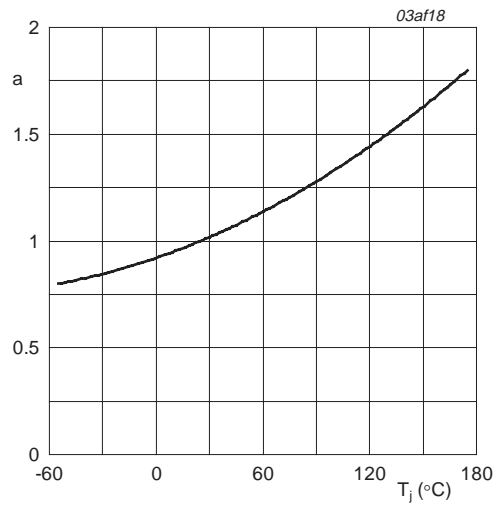

$$a = \frac{R_{DS(on)}}{R_{DS(on)(25\text{ °C})}}$$

Fig 8. Normalized drain-source on-state resistance factor as a function of junction temperature.

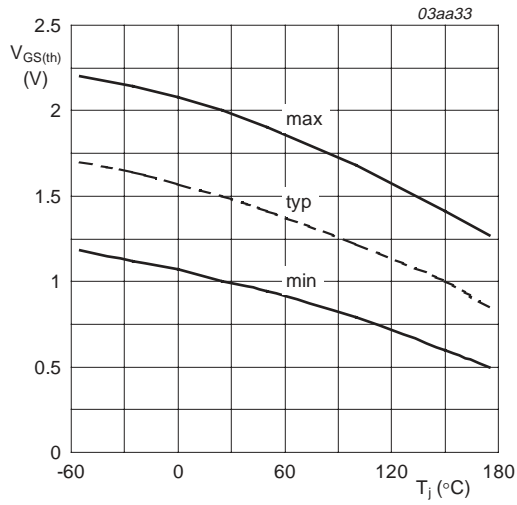

$I_D = 1 \text{ mA}; V_{DS} = V_{GS}$

Fig 9. Gate-source threshold voltage as a function of junction temperature.

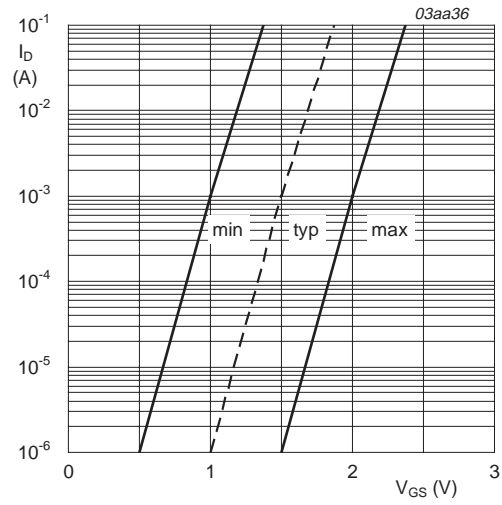

$T_j = 25 \text{ }^\circ\text{C}; V_{DS} = 5 \text{ V}$

Fig 10. Sub-threshold drain current as a function of gate-source voltage.

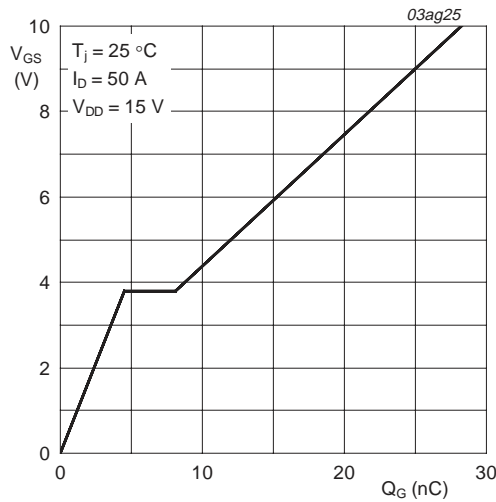

$I_D = 50 \text{ A}; V_{DS} = 15 \text{ V}$

Fig 11. Gate-source voltage as a function of gate charge; typical values.

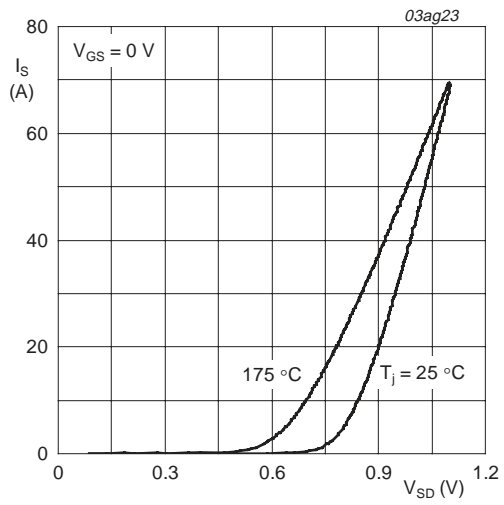

$T_J = 25\text{ °C}$ and 175 °C ; $V_{GS} = 0\text{ V}$

Fig 12. Source (diode forward) current as a function of source-drain (diode forward) voltage; typical values.

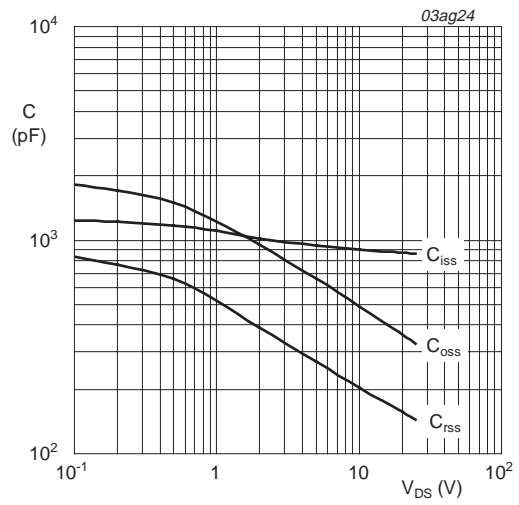

$V_{GS} = 0\text{ V}$; $f = 1\text{ MHz}$

Fig 13. Input, output and reverse transfer capacitances as a function of drain-source voltage; typical values.

7. Package outline

Plastic single-ended package; heatsink mounted; 1 mounting hole; 3-lead TO-220AB

SOT78

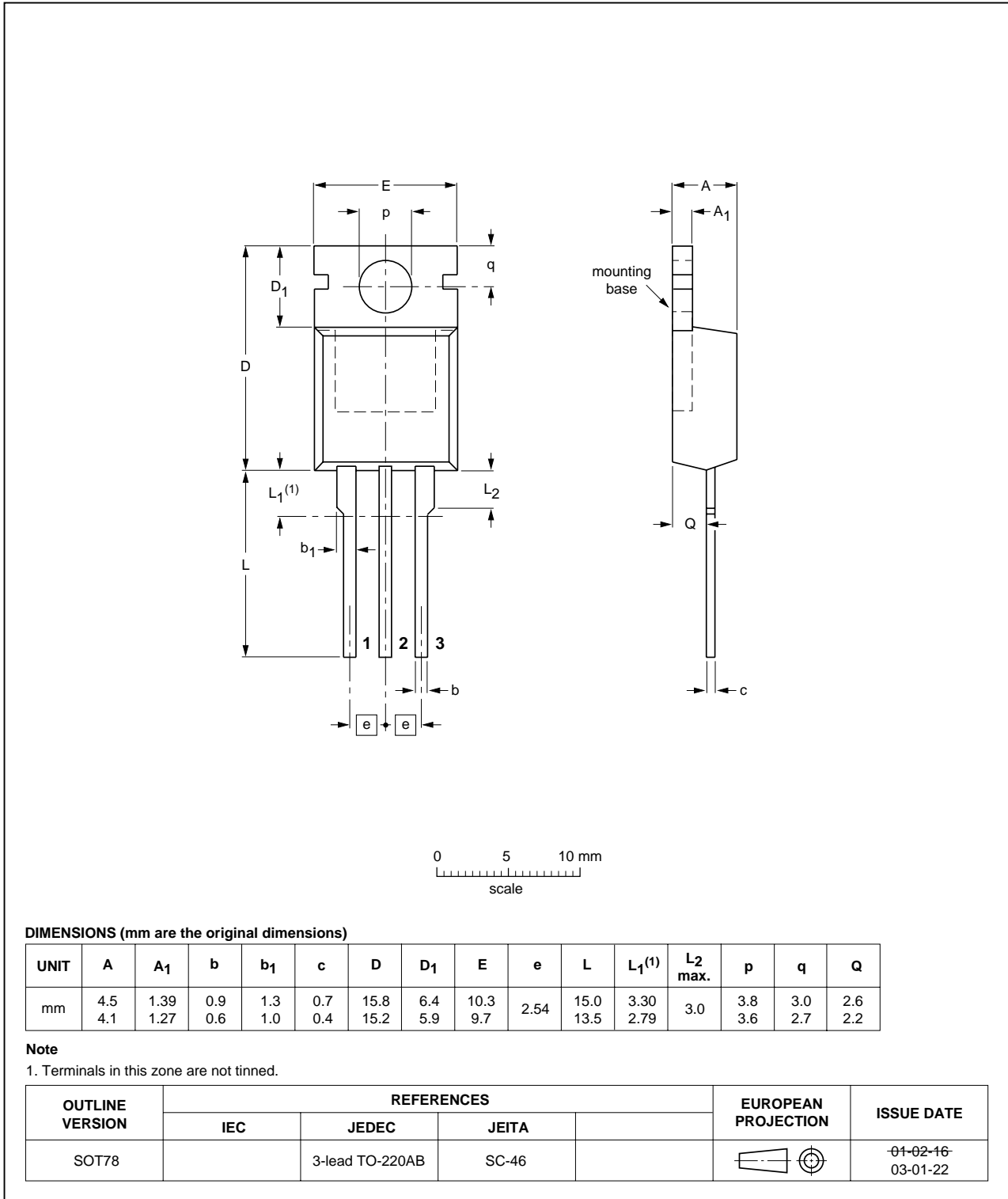

Fig 14. SOT78 (TO-220AB) package outline.

Plastic single-ended package (Philips version of I-PAK); 3 leads (in-line)

SOT533

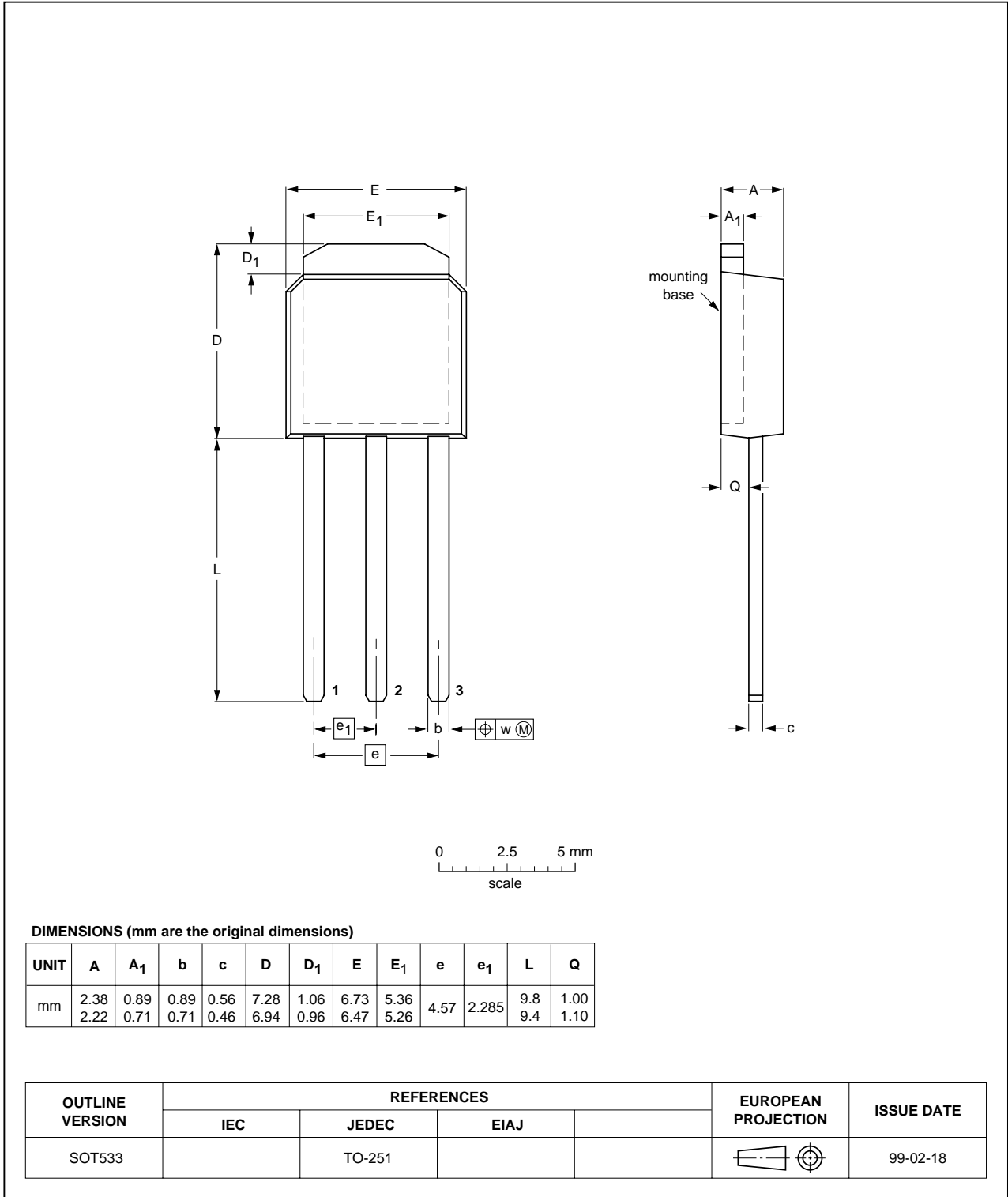

Fig 15. SOT533 (I-PAK) package outline.

8. Revision history

Table 6: Revision history

Document ID	Release date	Data sheet status	Change notice	Document number	Supersedes
PHP_PHU66NQ03LT_6	20040812	Product data sheet	-	9397 750 13428	PHP_PHB_PHD66NQ03LT_5
Modifications: <ul style="list-style-type: none"> • Removal of PHB66NQ03LT (now in separate data sheet) • Removal of PHD66NQ03LT (now in separate data sheet) • Addition of PHU66NQ03LT. • Data sheet updated to latest standard. 					
PHP_PHB_PHD66NQ03LT_5	20040415	Product data sheet	-	9397 750 13107	PHP_PHB_PHD66NQ03LT_4
PHP_PHB_PHD66NQ03LT_4	20020909	Product data sheet	-	9397 750 10158	PHP_PHB_PHD66NQ03LT_3
PHP_PHB_PHD66NQ03LT_3	20020312	Product data sheet	-	9397 750 09284	PHP_PHB_PHD66NQ03LT_2
PHP_PHB_PHD66NQ03LT_2	20011210	Product data sheet	-	9397 750 09119	PHP_PHB_PHD66NQ03LT_1
PHP_PHB_PHD66NQ03LT_1	20011012	Product data sheet	-	9397 750 08725	-

9. Data sheet status

Level	Data sheet status ^[1]	Product status ^[2] ^[3]	Definition
I	Objective data	Development	This data sheet contains data from the objective specification for product development. Philips Semiconductors reserves the right to change the specification in any manner without notice.
II	Preliminary data	Qualification	This data sheet contains data from the preliminary specification. Supplementary data will be published at a later date. Philips Semiconductors reserves the right to change the specification without notice, in order to improve the design and supply the best possible product.
III	Product data	Production	This data sheet contains data from the product specification. Philips Semiconductors reserves the right to make changes at any time in order to improve the design, manufacturing and supply. Relevant changes will be communicated via a Customer Product/Process Change Notification (CPCN).

[1] Please consult the most recently issued data sheet before initiating or completing a design.

[2] The product status of the device(s) described in this data sheet may have changed since this data sheet was published. The latest information is available on the Internet at URL <http://www.semiconductors.philips.com>.

[3] For data sheets describing multiple type numbers, the highest-level product status determines the data sheet status.

10. Definitions

Short-form specification — The data in a short-form specification is extracted from a full data sheet with the same type number and title. For detailed information see the relevant data sheet or data handbook.

Limiting values definition — Limiting values given are in accordance with the Absolute Maximum Rating System (IEC 60134). Stress above one or more of the limiting values may cause permanent damage to the device. These are stress ratings only and operation of the device at these or at any other conditions above those given in the Characteristics sections of the specification is not implied. Exposure to limiting values for extended periods may affect device reliability.

Application information — Applications that are described herein for any of these products are for illustrative purposes only. Philips Semiconductors make no representation or warranty that such applications will be suitable for the specified use without further testing or modification.

11. Disclaimers

Life support — These products are not designed for use in life support appliances, devices, or systems where malfunction of these products can reasonably be expected to result in personal injury. Philips Semiconductors

13. Contact information

For additional information, please visit: <http://www.semiconductors.philips.com>

For sales office addresses, send an email to: sales.addresses@www.semiconductors.philips.com

customers using or selling these products for use in such applications do so at their own risk and agree to fully indemnify Philips Semiconductors for any damages resulting from such application.

Right to make changes — Philips Semiconductors reserves the right to make changes in the products - including circuits, standard cells, and/or software - described or contained herein in order to improve design and/or performance. When the product is in full production (status 'Production'), relevant changes will be communicated via a Customer Product/Process Change Notification (CPCN). Philips Semiconductors assumes no responsibility or liability for the use of any of these products, conveys no license or title under any patent, copyright, or mask work right to these products, and makes no representations or warranties that these products are free from patent, copyright, or mask work right infringement, unless otherwise specified.

12. Trademarks

TrenchMOS — is a trademark of Koninklijke Philips Electronics N.V.

14. Contents

1	Product profile	1
1.1	General description	1
1.2	Features	1
1.3	Applications	1
1.4	Quick reference data	1
2	Pinning information	1
3	Ordering information	2
4	Limiting values	2
5	Thermal characteristics	4
5.1	Transient thermal impedance	4
6	Characteristics	5
7	Package outline	9
8	Revision history	11
9	Data sheet status	12
10	Definitions	12
11	Disclaimers	12
12	Trademarks	12
13	Contact information	12



© Koninklijke Philips Electronics N.V. 2004

All rights are reserved. Reproduction in whole or in part is prohibited without the prior written consent of the copyright owner. The information presented in this document does not form part of any quotation or contract, is believed to be accurate and reliable and may be changed without notice. No liability will be accepted by the publisher for any consequence of its use. Publication thereof does not convey nor imply any license under patent- or other industrial or intellectual property rights.

Date of release: 12 August 2004
Document order number: 9397 750 13428

Published in The Netherlands