

LMax Low Profile Power Inductor

LMLP Series – Style C

FEATURES

- Small and low profile inductor
- It corresponds to high current
- Simple and original magnetic shield structure

APPLICATIONS

- For small DC/DC converter (cellular phone, HDD, DVC, DSC, PDA, LCD display etc.)

CHARACTERISTICS

- Operating Temperature Range: -40°C to +125°C
- Storage Temperature Range: -40°C to +85°C
- Saturation Current: The saturation current value (ISAT) is the DC current value when the inductance decreases by 30% of its initial value (at 20°C).
- Temperature Rise Current: The temperature rise current value (IRMS) is the DC current value that increases component temperature by up to 40°C.

INDUCTANCE AND RATED CURRENT RANGES

• 0202	2.2 ~ 15μH	1.290 ~ 0.470A
• 0303	1.5 ~ 22μH	1.20 ~ 0.350A
• 03A2	1.5 ~ 22μH	1.36 ~ 0.370A
• 03B3	1.0 ~ 22μH	2.10 ~ 0.470A
• 04A4	1.0 ~ 22μH	2.50 ~ 0.510A
• 04B4	1.0 ~ 220μH	4.0 ~ 0.270A
• 05B5	1.50 ~ 22.0μH	3.35 ~ 0.90A
• 05D5	1.50 ~ 47.0μH	6.00 ~ 1.10A
• 06B6	1.50 ~ 22.0μH	4.00 ~ 1.05A
• 06C6	1.50 ~ 100μH	5.00 ~ 0.62A
• 06D6	1.30 ~ 100μH	8.00 ~ 0.80A
• 0808	0.90 ~ 22μH	11.0 ~ 2.2A



DIMENSIONS

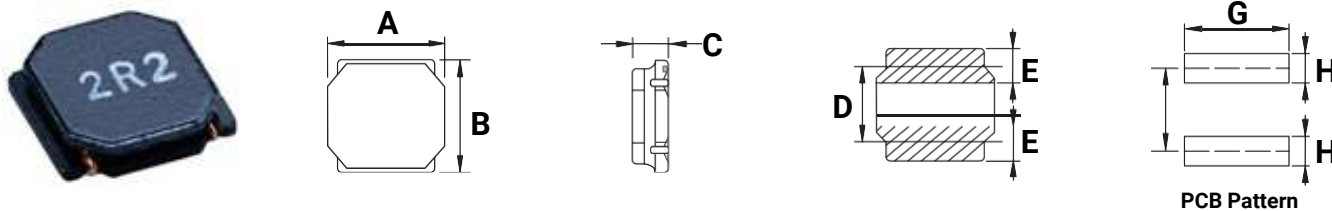

mm (inches)

Type	A	B	C max	D	E	F	G	H
0202	2.50 ± 0.20 (0.095 ± 0.004)	2.00 ± 0.20 (0.095 ± 0.004)	1.05 (0.039)	1.45 ± 0.20 (0.057 ± 0.008)	0.60 ± 0.20 (0.240 ± 0.008)	1.45 (0.057)	2.00 (0.079)	0.70 (0.028)
0303	3.00 ± 0.20 (0.118 ± 0.008)	3.00 ± 0.20 (0.118 ± 0.008)	1.00 (0.039)	1.90 ± 0.20 (0.075 ± 0.008)	0.90 ± 0.20 (0.035 ± 0.008)	2.20 (0.087)	2.70 (0.106)	0.80 (0.032)
03A2	3.00 ± 0.20 (0.118 ± 0.008)	3.00 ± 0.20 (0.118 ± 0.008)	1.20 (0.047)	1.90 ± 0.20 (0.075 ± 0.008)	0.90 ± 0.20 (0.035 ± 0.008)	2.20 (0.087)	2.70 (0.106)	0.80 (0.032)
03B3	3.00 ± 0.20 (0.118 ± 0.008)	3.00 ± 0.20 (0.118 ± 0.008)	1.50 (0.059)	1.90 ± 0.20 (0.075 ± 0.008)	0.90 ± 0.20 (0.035 ± 0.008)	2.20 (0.087)	2.70 (0.106)	0.80 (0.032)
04A4	4.00 ± 0.20 (0.157 ± 0.008)	4.00 ± 0.20 (0.157 ± 0.008)	1.20 (0.047)	2.50 ± 0.20 (0.099 ± 0.008)	1.10 ± 0.20 (0.043 ± 0.008)	2.80 (0.110)	3.70 (0.146)	1.20 (0.047)
04B4	4.00 ± 0.20 (0.157 ± 0.008)	4.00 ± 0.20 (0.157 ± 0.008)	1.85 (0.071)	2.50 ± 0.20 (0.099 ± 0.008)	1.10 ± 0.20 (0.043 ± 0.008)	2.80 (0.110)	3.70 (0.146)	1.20 (0.047)
05B5	5.00 ± 0.20 (0.197 ± 0.008)	5.00 ± 0.20 (0.197 ± 0.008)	2.00 (0.078)	3.50 ± 0.20 (0.138 ± 0.008)	1.50 ± 0.20 (0.059 ± 0.008)	3.80 (0.150)	4.70 (0.185)	1.60 (0.063)
05D5	5.00 ± 0.20 (0.197 ± 0.008)	5.00 ± 0.20 (0.197 ± 0.008)	4.00 (0.157)	3.50 ± 0.20 (0.138 ± 0.008)	1.50 ± 0.20 (0.059 ± 0.008)	3.80 (0.150)	4.70 (0.185)	1.60 (0.063)
06B6	6.00 ± 0.30 (0.236 ± 0.008)	6.00 ± 0.30 (0.236 ± 0.008)	2.00 (0.078)	4.00 ± 0.20 (0.157 ± 0.008)	1.35 ± 0.20 (0.053 ± 0.008)	4.70 (0.185)	5.70 (0.224)	1.60 (0.063)
06C6	6.00 ± 0.30 (0.236 ± 0.008)	6.00 ± 0.30 (0.236 ± 0.008)	2.80 (0.110)	4.00 ± 0.20 (0.157 ± 0.008)	1.35 ± 0.20 (0.053 ± 0.008)	4.70 (0.185)	5.70 (0.224)	1.60 (0.063)
06D6	6.00 ± 0.20 (0.236 ± 0.008)	6.00 ± 0.20 (0.236 ± 0.008)	4.50 (0.177)	4.00 ± 0.20 (0.157 ± 0.008)	1.35 ± 0.20 (0.053 ± 0.008)	4.70 (0.185)	5.70 (0.224)	1.60 (0.063)
0808	8.00 ± 0.20 (0.315 ± 0.008)	8.00 ± 0.20 (0.315 ± 0.008)	4.20 (0.165)	5.60 ± 0.30 (0.220 ± 0.011)	1.60 ± 0.30 (0.063 ± 0.011)	5.60 (0.220)	7.50 (0.188)	1.80 (0.071)

LMax Low Profile Power Inductor

LMLP Series – Style C



HOW TO ORDER

LM	LP	0303	M	R04	C	T	A	S
Family	Series	Size	Tolerance	Inductance	Style	Termination	Special	Packaging
LM = Power Inductor	LP = Low Profile	0303 = 3x3xh 03A3 = 3x3xA(h) (h = see catalog)	M = 20% N = 30%	R39 = 0.390μH 3R9 = 3.900μH 390 = 39.00μH 391 = 390.0μH		T = Sn Plate	A = Standard	R = 7" Reel S = 13" Reel

ELECTRICAL CHARACTERISTICS

0202

Part Number	L (μH) at 100KHz 1.0V	Tolerance	I _{SAT} * (A)	I _{RMS} ** (A)	DCR ±20% (Ω)
LMLP0202N2R2CTAR	2.2	±30%	1.29	0.97	0.15
LMLP0202N3R3CTAR	3.3	±30%	1	0.77	0.22
LMLP0202N4R7CTAR	4.7	±30%	0.88	0.67	0.29
LMLP0202N6R8CTAR	6.8	±30%	0.75	0.57	0.41
LMLP0202M100CTAR	10	±20%	0.55	0.45	0.69
LMLP0202M150CTAR	15	±20%	0.47	0.37	1.02

0303

Part Number	L (μH) at 100KHz 1.0V	Tolerance	I _{SAT} * (A)	I _{RMS} ** (A)	DCR ±20% (Ω)
LMLP0303N1R5CTAR	1.5	±30%	1.2	1.3	0.08
LMLP0303N2R2CTAR	2.2	±30%	1.1	1.1	0.095
LMLP0303N3R3CTAR	3.3	±30%	0.87	0.94	0.14
LMLP0303N4R7CTAR	4.7	±30%	0.75	0.78	0.19
LMLP0303N6R8CTAR	6.8	±30%	0.61	0.63	0.3
LMLP0303M100CTAR	10	±20%	0.5	0.51	0.45
LMLP0303M150CTAR	15	±20%	0.4	0.4	0.74
LMLP0303M220CTAR	22	±20%	0.35	0.35	1.03

03A2

Part Number	L (μH) at 100KHz 1.0V	Tolerance	I _{SAT} * (A)	I _{RMS} ** (A)	DCR ±20% (Ω)
LMLP03A2N1R5CTAR	1.5	±30%	1.36	1.4	0.06
LMLP03A2N2R2CTAR	2.2	±30%	1.1	1.2	0.08
LMLP03A2N3R3CTAR	3.3	±30%	0.91	1.05	0.1
LMLP03A2N4R7CTAR	4.7	±30%	0.77	0.98	0.13
LMLP03A2N6R8CTAR	6.8	±30%	0.67	0.74	0.19
LMLP03A2M100CTAR	10	±20%	0.54	0.63	0.29
LMLP03A2M150CTAR	15	±20%	0.44	0.485	0.45
LMLP03A2M220CTAR	22	±20%	0.37	0.42	0.63

*The saturation current value (ISAT) is the DC current value when the inductance decreases by 30% of its initial value (at 20°C).

**The temperature rise current value (IRMS) is the DC current value that increases component temperature by up to 40°C.

LMax Low Profile Power Inductor

LMLP Series – Style C

03B3

Part Number	L (μH) at 100KHz 1.0V	Tolerance	I _{SAT} * (A)	I _{RMS} ** (A)	DCR ±20% (Ω)
LMLP03B3N1R0CTAR	1.0	±30%	2.1	2.1	0.03
LMLP03B3N1R5CTAR	1.5	±30%	1.8	1.82	0.04
LMLP03B3N2R2CTAR	2.2	±30%	1.48	1.5	0.06
LMLP03B3N3R3CTAR	3.3	±30%	1.21	1.23	0.08
LMLP03B3N4R7CTAR	4.7	±30%	1.02	1.04	0.12
LMLP03B3N6R8CTAR	6.8	±30%	0.87	0.88	0.16
LMLP03B3M100CTAR	10	±20%	0.7	0.71	0.23
LMLP03B3M220CTAR	22	±20%	0.47	0.47	0.52

04A4

Part Number	L (μH) at 100KHz 1.0V	Tolerance	I _{SAT} * (A)	I _{RMS} ** (A)	DCR ±20% (Ω)
LMLP04A4N1R0CTAS	1.0	±30%	2.5	1.5	0.06
LMLP04A4N2R2CTAS	2.2	±30%	1.65	1.2	0.09
LMLP04A4N3R3CTAS	3.3	±30%	1.2	0.98	0.13
LMLP04A4N4R7CTAS	4.7	±30%	1.05	0.96	0.14
LMLP04A4N6R8CTAS	6.8	±30%	0.9	0.84	0.18
LMLP04A4M100CTAS	10	±20%	0.74	0.77	0.24
LMLP04A4M150CTAS	15	±20%	0.56	0.6	0.4
LMLP04A4M220CTAS	22	±20%	0.51	0.54	0.48

*The saturation current value (ISAT) is the DC current value when the inductance decreases by 30% of its initial value (at 20°C).

**The temperature rise current value (IRMS) is the DC current value that increases component temperature by up to 40°C.

LMax Low Profile Power Inductor

LMLP Series – Style C

04B4

Part Number	L (μH) at 100KHz 1.0V	Tolerance	I _{SAT} * (A)	I _{RMS} ** (A)	DCR ±20% (Ω)
LMLP04B4N1R0CTAS	1.0	±30%	4	1.83	0.03
LMLP04B4N2R2CTAS	2.2	±30%	2.7	1.44	0.06
LMLP04B4N3R3CTAS	3.3	±30%	2	1.23	0.07
LMLP04B4N4R7CTAS	4.7	±30%	1.7	1.2	0.09
LMLP04B4N6R8CTAS	6.8	±30%	1.45	1.06	0.11
LMLP04B4M100CTAS	10	±20%	1.2	0.84	0.18
LMLP04B4M150CTAS	15	±20%	0.94	0.65	0.28
LMLP04B4M220CTAS	22	±20%	0.8	0.59	0.36
LMLP04B4M330CTAS	33	±20%	0.65	0.49	0.53
LMLP04B4M470CTAS	47	±20%	0.57	0.42	0.65
LMLP04B4M680CTAS	68	±20%	0.47	0.32	1
LMLP04B4M101CTAS	100	±20%	0.4	0.27	1.5
LMLP04B4M221CTAS	220	±20%	0.27	0.17	4

05B5

Part Number	L (μH) at 100KHz 1.0V	Tolerance	I _{SAT} * (A)	I _{RMS} ** (A)	DCR ±20% (Ω)
LMLP05B5N1R5CTAS	1.5	±30%	3.35	3.2	0.026
LMLP05B5N2R2CTAS	2.2	±30%	2.9	2.9	0.035
LMLP05B5N3R3CTAS	3.3	±30%	2.4	2.4	0.048
LMLP05B5N4R7CTAS	4.7	±30%	2	2	0.06
LMLP05B5N6R8CTAS	6.8	±30%	1.6	1.65	0.09
LMLP05B5M100CTAS	10	±20%	1.3	1.45	0.12
LMLP05B5M150CTAS	15	±20%	1.1	1.2	0.165
LMLP05B5M220CTAS	22	±20%	0.9	1	0.26

05D5

Part Number	L (μH) at 100KHz 1.0V	Tolerance	I _{SAT} * (A)	I _{RMS} ** (A)	DCR ±20% (Ω)
LMLP05D5N1R5CTAS	1.5	±30%	6	3.6	0.02
LMLP05D5N2R2CTAS	2.2	±30%	4.6	3.5	0.022
LMLP05D5N3R3CTAS	3.3	±30%	3.8	3.3	0.027
LMLP05D5N4R7CTAS	4.7	±30%	3.3	3.1	0.029
LMLP05D5N6R8CTAS	6.8	±30%	2.6	2.3	0.049
LMLP05D5M100CTAS	10	±20%	2.3	2.1	0.056
LMLP05D5M150CTAS	15	±20%	2	1.8	0.08
LMLP05D5M220CTAS	22	±20%	1.6	1.4	0.126
LMLP05D5M330CTAS	33	±20%	1.3	1.2	0.18
LMLP05D5M470CTAS	47	±20%	1.1	0.9	0.31

*The saturation current value (ISAT) is the DC current value when the inductance decreases by 30% of its initial value (at 20°C).

**The temperature rise current value (IRMS) is the DC current value that increases component temperature by up to 40°C.

LMax Low Profile Power Inductor

LMLP Series – Style C

06B6

Part Number	L (μH) at 100KHz 1.0V	Tolerance	I _{SAT} * (A)	I _{RMS} ** (A)	DCR ±20% (Ω)
LMLP06B6N1R5CTAS	1.5	±30%	4	3.2	0.026
LMLP06B6N2R2CTAS	2.2	±30%	3.2	2.7	0.034
LMLP06B6N3R3CTAS	3.3	±30%	2.8	2.6	0.04
LMLP06B6N4R7CTAS	4.7	±30%	2.4	2	0.058
LMLP06B6N6R8CTAS	6.8	±30%	2	1.8	0.085
LMLP06B6M100CTAS	10	±20%	1.7	1.4	0.125
LMLP06B6M220CTAS	22	±20%	1.05	0.95	0.29

06C6

Part Number	L (μH) at 100KHz 1.0V	Tolerance	I _{SAT} * (A)	I _{RMS} ** (A)	DCR ±20% (Ω)
LMLP06C6N1R5CTAS	1.5	±30%	5	4.2	0.016
LMLP06C6N2R2CTAS	2.2	±30%	4.2	3.7	0.02
LMLP06C6N3R0CTAS	3	±30%	3.6	3.4	0.023
LMLP06C6N4R7CTAS	4.7	±30%	2.7	3	0.031
LMLP06C6N6R0CTAS	6	±30%	2.5	2.5	0.04
LMLP06C6M100CTAS	10	±20%	1.9	1.9	0.065
LMLP06C6M150CTAS	15	±20%	1.6	1.8	0.095
LMLP06C6M220CTAS	22	±20%	1.3	1.4	0.135
LMLP06C6M330CTAS	33	±20%	1.1	1.1	0.22
LMLP06C6M470CTAS	47	±20%	0.95	0.92	0.3
LMLP06C6M680CTAS	68	±20%	0.76	0.77	0.42
LMLP06C6M101CTAS	100	±20%	0.62	0.66	0.6

*The saturation current value (ISAT) is the DC current value when the inductance decreases by 30% of its initial value (at 20°C).

**The temperature rise current value (IRMS) is the DC current value that increases component temperature by up to 40°C.

LMax Low Profile Power Inductor

LMLP Series – Style C



06D6

Part Number	L (μH) at 100KHz 1.0V	Tolerance	I _{SAT} * (A)	I _{RMS} ** (A)	DCR ±20% (Ω)
LMLP06D6N1R3CTAS	1.3	±30%	8	4	0.016
LMLP06D6N1R8CTAS	1.8	±30%	7	3.7	0.018
LMLP06D6N2R3CTAS	2.3	±30%	6	3.5	0.021
LMLP06D6N3R0CTAS	3	±30%	5	3.2	0.024
LMLP06D6N4R5CTAS	4.5	±30%	4	3	0.031
LMLP06D6N6R3CTAS	6.3	±30%	3.8	2.8	0.038
LMLP06D6M100CTAS	10	±20%	3	2.5	0.047
LMLP06D6M150CTAS	15	±20%	2.3	1.9	0.077
LMLP06D6M220CTAS	22	±20%	1.9	1.5	0.115
LMLP06D6M330CTAS	33	±20%	1.5	1.4	0.145
LMLP06D6M470CTAS	47	±20%	1.3	1.1	0.22
LMLP06D6M680CTAS	68	±20%	1	0.9	0.33
LMLP06D6M101CTAS	100	±20%	0.8	0.7	0.5

0808

Part Number	L (μH) at 100KHz 1.0V	Tolerance	I _{SAT} * (A)	I _{RMS} ** (A)	DCR ±20% (Ω)
LMLP0808N0R9CTAS	0.9	±30%	11	7.8	0.006
LMLP0808N1R4CTAS	1.4	±30%	9	7	0.007
LMLP0808N2R0CTAS	2	±30%	7.4	6.3	0.009
LMLP0808N3R6CTAS	3.6	±30%	5.3	4.9	0.015
LMLP0808N4R7CTAS	4.7	±30%	4.7	4.1	0.018
LMLP0808N6R8CTAS	6.8	±30%	4	3.7	0.025
LMLP0808M100CTAS	10	±20%	3.4	3.1	0.034
LMLP0808M150CTAS	15	±20%	2.7	2.4	0.05
LMLP0808M220CTAS	22	±20%	2.2	2.2	0.066

*The saturation current value (ISAT) is the DC current value when the inductance decreases by 30% of its initial value (at 20°C).

**The temperature rise current value (IRMS) is the DC current value that increases component temperature by up to 40°C.

RECOMMENDED REFLOW PROFILE

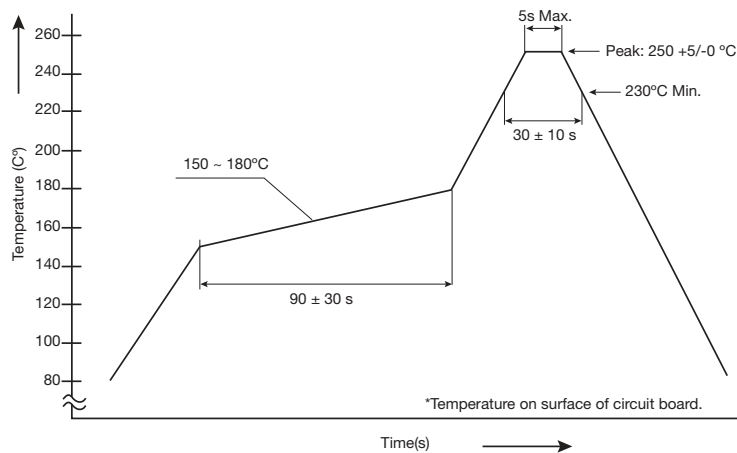



The products may be exposed to reflow soldering process of above profile up to two times.

LMax Low Profile Power Inductor

LMLP Series – Style C

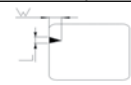
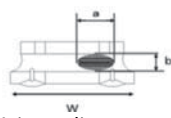
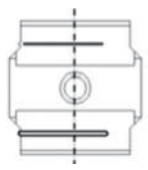
TEST CONDITIONS

ITEM	SPECIFICATION DESCRIPTION	TEST METHOD
Temperature Range	Operation temp.: -40°C ~ +125°C (Including self-generated heat) Storage temp.: -40°C ~ +85°C	–
Appearance	No defects or abnormalities.	Visual inspection
Core Chipping	The appearance standard of the chipping size in top side, of bottom side ferrite core is following dimension. L: 0.5 mm (max) W: 0.5 mm (max)	 Using calipers
Void Appearance Exposed	Size of voids occurring to coating resin is specified as following. 1. Width direction (dimension a): acceptable when $a \leq w/2$ nonconforming when $a > w/2$ 2. Length direction (dimension b): it is not specified. 3. When total area of voids (including one exposing coil) occurring to each sides is not greater than 50% of coating resin area that is acceptable	 Using calipers
Electrode Appearance Criterion for Exposed Wire	 <Cross section of wire joint part> Only top side of wire exposed. (regardless of whole top side of wire exposed)	<Appearance judgement> Conforming
Solderability	 Wire is soldered insufficiently and less than half of outer diameter is covered with solder.	Less than 1/2 of joint side Length (More than 1/2 is selected as defect) Solder heat proof: 1. Preheating: 160±10°C 90s 2. Retention time: 245±5°C for 3 ± 1 sec
Vibration	Inductance change: within ± 10% without mechanical damage such as break	1. Vibration frequency: (10Hz to 55Hz to 10Hz) in 60 sec. as a period 2. Vibration time: period cycled for 2 hr in each of 3 mutual perpendicular directions 3. Amplitude: 1.5mm max.
Terminal Strength	No detachment of terminal pin and no breakage of wire	Add static load 4.9N(500gf) to inductor through hole of test board for 10 ± 2 sec
Thermal Shock	Inductance change: within ± 10% without mechanical damage such as break	1. Repeat 100 cycles as follow: (-40°C ± 2°C, 30 ± 3 minutes) → (room temperature, 5 minutes) → (+125°C ± 2°C, 30 ± 3 minutes) → (room temperature, 5 minutes) 2. Recovery: 48 +4/-0 hours of recovery under the standard condition after the test.
High Temperature Resistance	Inductance change: within ± 10% without mechanical damage such as break	1. Environment condition: 85°C ± 2°C 2. Applied current: rated current 3. Duration: 500 +4/-0 hours
Humidity Resistance	Inductance change: within ± 10% without mechanical damage such as break	1. Environment condition: 60°C ± 2°C 2. Humidity: 90~95% 3. Applied current: rated current 4. Duration: 500 +4/-0 hours
Low Temperature Storage	Inductance change: within ± 10% without mechanical damage such as break	Store temperature: -40°C ± 2°C for total 500 +4/-0 hours
High Temperature Storage	Inductance change: within ± 10% without mechanical damage such as break	Store temperature: +125°C ± 2°C for total 500 +4/-0 hours
Inductance	a. Temperature: 25 ± 3°C b. Relative Humidity: 45 to 75%RH c. Measuring equipment: Current measure: Chroma 3302 + Chroma 1320	Within specified tolerance
DC Resistance	Measuring instrument: Chroma A165022	In accordance with electrical specification.

LMax Low Profile Power Inductor

LMLP Series – Style C



PACKAGING SPECIFICATIONS – CARRIER TAPE DIMENSIONS

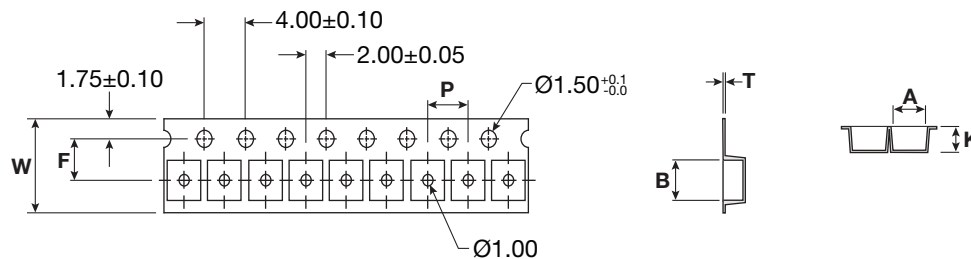

Part Number	mm (inches)							Reel Size	SPQ
	A	B	P	F	W	T	K		
LMLP0202****CTAR	2.6 ± 0.1 (0.102 ± 0.004)	2.6 ± 0.1 (0.102 ± 0.004)	4 ± 0.1 (0.157 ± 0.004)	3.5 ± 0.1 (0.138 ± 0.004)	8.0 ± 0.2 (0.315 ± 0.008)	0.25 ± 0.05 (0.009 ± 0.002)	1.3 ± 0.1 (0.051 ± 0.004)	7"	2000
LMLP0303****CTAR	3.2 ± 0.1 (0.126 ± 0.004)	3.2 ± 0.1 (0.126 ± 0.004)	4.0 ± 0.1 (0.157 ± 0.004)	3.5 ± 0.1 (0.138 ± 0.004)	8.0 ± 0.2 (0.315 ± 0.008)	0.3 ± 0.05 (0.012 ± 0.002)	1.4 ± 0.1 (0.055 ± 0.004)	7"	2000
LMLP03A2****CTAR	3.2 ± 0.1 (0.126 ± 0.004)	3.2 ± 0.1 (0.126 ± 0.004)	4.0 ± 0.1 (0.157 ± 0.004)	3.5 ± 0.1 (0.138 ± 0.004)	8.0 ± 0.2 (0.315 ± 0.008)	0.3 ± 0.05 (0.012 ± 0.002)	1.6 ± 0.1 (0.063 ± 0.004)	7"	2000
LMLP03B3****CTAR	3.2 ± 0.1 (0.126 ± 0.004)	3.2 ± 0.1 (0.126 ± 0.004)	4.0 ± 0.1 (0.157 ± 0.004)	3.5 ± 0.1 (0.138 ± 0.004)	8.0 ± 0.2 (0.315 ± 0.008)	0.3 ± 0.05 (0.012 ± 0.002)	1.9 ± 0.1 (0.075 ± 0.004)	7"	2000
LMLP04A4****CTAS	4.3 ± 0.1 (0.169 ± 0.004)	4.3 ± 0.1 (0.169 ± 0.004)	8.0 ± 0.1 (0.315 ± 0.004)	5.5 ± 0.1 (0.217 ± 0.004)	12.0 ± 0.3 (0.472 ± 0.012)	0.3 ± 0.1 (0.012 ± 0.004)	1.6 ± 0.1 (0.063 ± 0.004)	13"	4500
LMLP04B4****CTAS	4.3 ± 0.1 (0.169 ± 0.004)	4.3 ± 0.1 (0.169 ± 0.004)	8.0 ± 0.1 (0.315 ± 0.004)	5.5 ± 0.1 (0.217 ± 0.004)	12.0 ± 0.3 (0.472 ± 0.012)	0.3 ± 0.1 (0.012 ± 0.004)	2.1 ± 0.1 (0.083 ± 0.004)	13"	3000
LMLP05B5****CTAR	5.25 ± 0.1 (0.207 ± 0.004)	5.25 ± 0.1 (0.207 ± 0.004)	8.0 ± 0.1 (0.315 ± 0.004)	5.5 ± 0.1 (0.217 ± 0.004)	12.0 ± 0.3 (0.472 ± 0.012)	0.3 ± 0.1 (0.012 ± 0.004)	2.3 ± 0.1 (0.091 ± 0.004)	13"	3000
LMLP05D5****CTAS	5.15 ± 0.1 (0.203 ± 0.004)	5.15 ± 0.1 (0.203 ± 0.004)	8.0 ± 0.1 (0.315 ± 0.004)	5.5 ± 0.1 (0.217 ± 0.004)	12.0 ± 0.3 (0.472 ± 0.012)	0.4 ± 0.1 (0.016 ± 0.004)	4.2 ± 0.1 (0.165 ± 0.004)	13"	1500
LMLP06B6****CTAS	6.3 ± 0.1 (0.248 ± 0.004)	6.3 ± 0.1 (0.248 ± 0.004)	8.0 ± 0.1 (0.315 ± 0.004)	5.5 ± 0.1 (0.217 ± 0.004)	12.0 ± 0.3 (0.472 ± 0.012)	0.4 ± 0.1 (0.016 ± 0.004)	2.3 ± 0.1 (0.091 ± 0.004)	13"	3000
LMLP06C6****CTAS	6.3 ± 0.1 (0.248 ± 0.004)	6.3 ± 0.1 (0.248 ± 0.004)	8.0 ± 0.1 (0.315 ± 0.004)	5.5 ± 0.1 (0.217 ± 0.004)	12.0 ± 0.3 (0.472 ± 0.012)	0.4 ± 0.1 (0.016 ± 0.004)	3.1 ± 0.1 (0.122 ± 0.004)	13"	2000
LMLP06D6****CTAS	6.3 ± 0.1 (0.248 ± 0.004)	6.3 ± 0.1 (0.248 ± 0.004)	8.0 ± 0.1 (0.315 ± 0.004)	5.5 ± 0.1 (0.217 ± 0.004)	12.0 ± 0.3 (0.472 ± 0.012)	0.4 ± 0.1 (0.016 ± 0.004)	4.7 ± 0.1 (0.185 ± 0.004)	13"	1500
LMLP0808****CTAS	8.3 ± 0.1 (0.327 ± 0.004)	8.3 ± 0.1 (0.327 ± 0.004)	12.0 ± 0.1 (0.472 ± 0.004)	7.5 ± 0.1 (0.295 ± 0.004)	16.0 ± 0.3 (0.630 ± 0.012)	0.5 ± 0.1 (0.020 ± 0.004)	4.5 ± 0.1 (0.177 ± 0.004)	13"	1000

PACKAGING SPECIFICATIONS – REEL DIMENSIONS

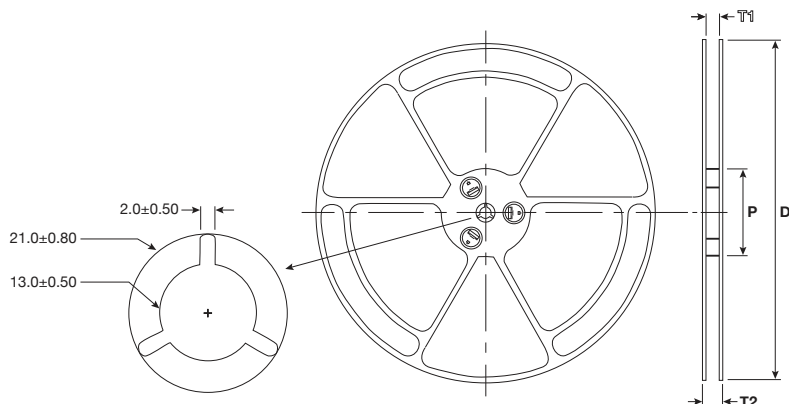

Code	7" Reel	13" Reel
D	180±1.50	330±1.50
P	62.0±1.50	100±1.50