



*The Power of Linking Together*

**ABRACON  
CORPORATION**

**Abracon PTM  
Introduction to ANFCA Series  
Flexible Peel & Stick NFC Antennas**

**Crystals  
Oscillators  
Filters  
Precision Timing  
Inductors**



# ANFCA Series Flexible Peel & Stick NFC Antennas

## Purpose

To introduce ANFCA Series, Flexible Peel & Stick NFC Antennas.

## Objective

Present the advantage, performance and applications of Abracon ANFCA Series.

## Content

14 pages

## Learning Time

25 minutes

Welcome to Abracon's ANFCA Series; NFC Antenna Training Module. This training session will provide an overview of the key features and benefits; as well as, discuss the applications of this product series.

Crystals  
Oscillators  
Filters  
Precision Timing  
Inductors

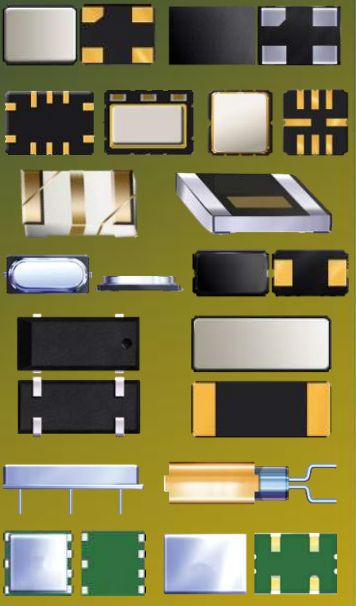



# Product - ANFCA Series Flexible Peel & Stick NFC Antennas

## Abracon ANFCA Series-Part Numbering

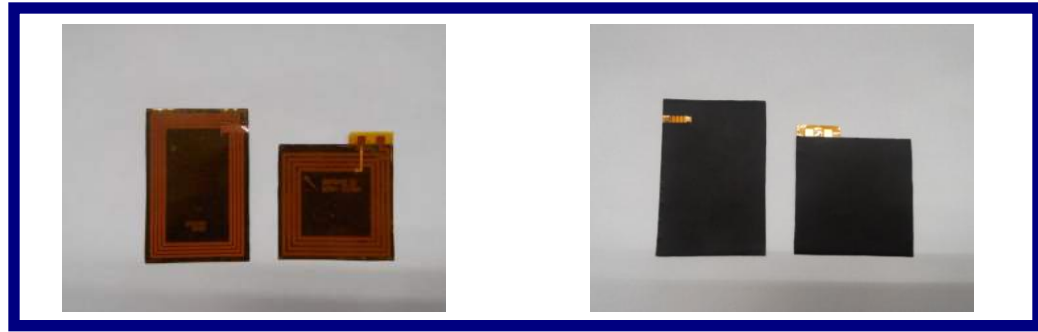

Crystals  
Oscillators  
Filters  
Precision Timing  
Inductors

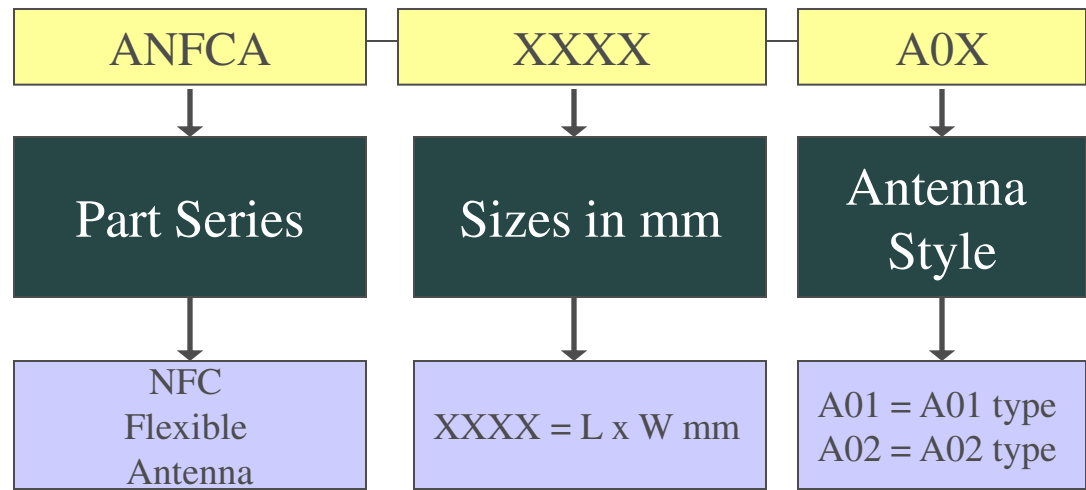
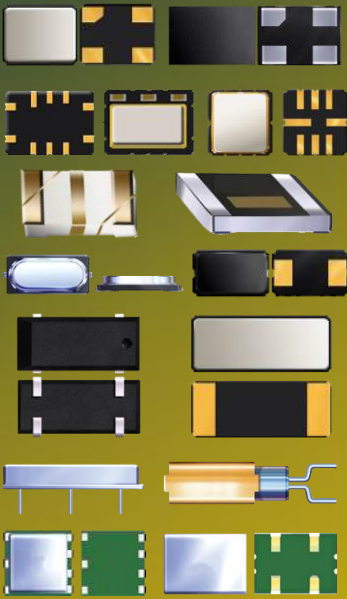

The ANFCA Series is a range of Flexible Peel & Stick NFC Antennas as described by the part numbering scheme.



# ANFCA Series – Part Numbering & Sizes

Part Number	Size
ANFCA-6040-A02	60x40mm
ANFCA-5040-A02	50x40mm
ANFCA-5035-A01	50x35mm
ANFCA-4545-A01	45x45mm
ANFCA-4535-A01	45x35mm
ANFCA-4040-A02	40x40mm
ANFCA-4030-A01	40x30mm
ANFCA-4030-A02	40x30mm
ANFCA-3225-A02	32x25mm
ANFCA-2525-A02	25x25mm
ANFCA-2515-A02	25x15mm
ANFCA-1510-A02	15x10mm

Crystals  
Oscillators  
Filters  
Precision Timing  
Inductors

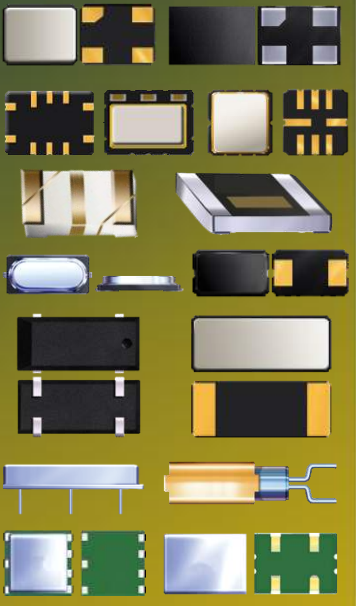

## CUSTOMIZATION AVAILABLE TO CUSTOMERS SIZES

The ANFCA Series covers 12 sizes, 60x40 to 15x10mm with the option to **customize**. The antennas are designed to operate at 13.56MHz. They are constructed from a flexible, very thin layered structure of adhesive tape, flexible printed circuit (FPC), PET tape and ferrite sheet to form a compact peel and stick NFC antenna.



# What is NFC?

## What is NFC and how does it differ from RFID?

- NFC stands for **Near field Communications**
  - RFID stands from **Radio Frequency Identification.**
  - Both technologies operate at **13.56MHz**
- 
- **RFID Readers** works by interfacing with RFID tags.
  - RFID is a **one-way** communication system, in which data flows from tags to the reading equipment only.
  - **NFC enabled devices** can operate as a **one way** or **bi-directional** communication system, and have three modes of operation.
- 1) **NFC Reader/Writer Mode:** NFC device reads tags to initiate services.
  - 2) **NFC Peer-to-Peer mode:** NFC devices communicate between each other to exchange data locally, or enable a function to allow higher data transfer.
  - 3) **NFC Card Emulation Mode:** This mode of NFC is used for payment and ticketing. The NFC device will act like an external contact less smart card.

NFC is a new and growing technology that will exploit areas where RFID existed, but will also allow bi-directional communication. Many Apps are being developed to utilize these functions like peer-to-peer sharing of Apps, pictures or data.

Crystals  
Oscillators  
Filters  
Precision Timing  
Inductors





# Example of NFC Reader and Tag

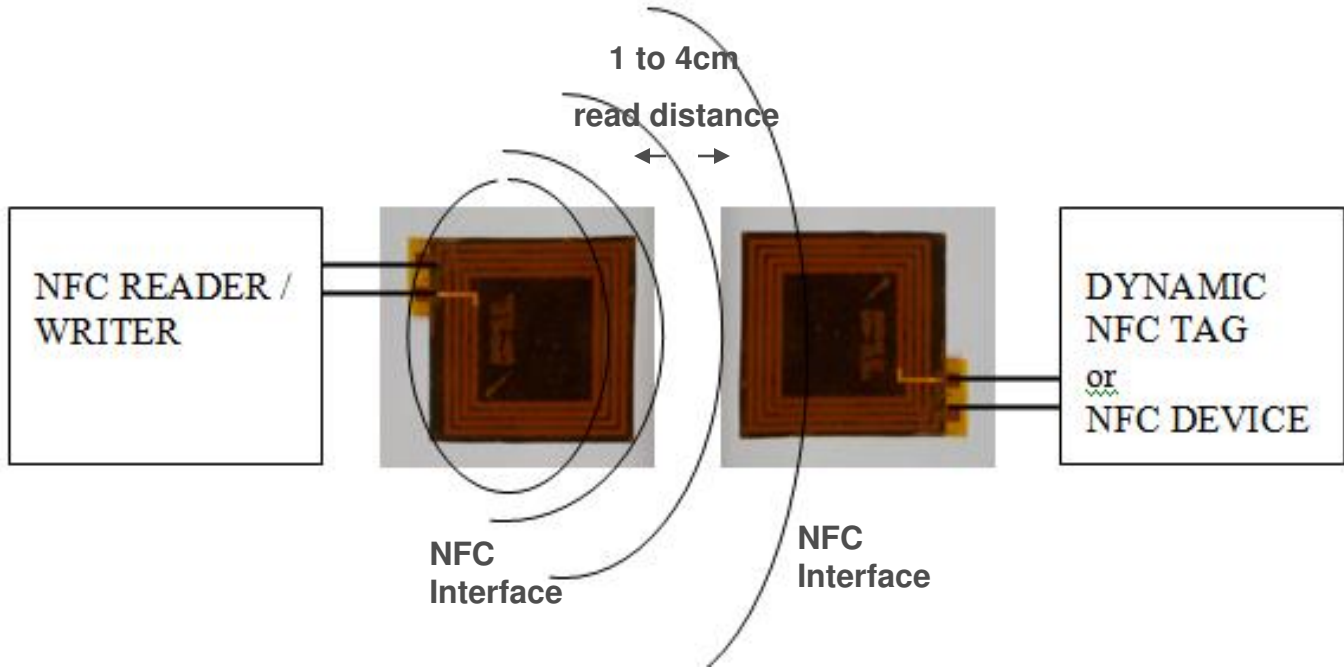

Today, the most recognized NFC application for consumers is **contactless purchases** with smartphones. Soon NFC will contribute to connecting objects to the “Internet of Things”, and NFC connectivity will be seen in many other kinds of electrical or electronic devices.

This example shows the diagram of a NFC system allowing 2 way communications. Although NFC only operates over a “read distance” of 1cm to 4cm, it will contribute to connecting objects to the “Internet of Things”, enabling many kinds of devices from loudspeakers and printers, to cookers and washing machines, to electricity, gas and water meters.

**Crystals**  
**Oscillators**  
**Filters**  
**Precision Timing**  
**Inductors**

**ABRACON CORPORATION**



Crystals  
Oscillators  
Filters  
Precision Timing  
Inductors

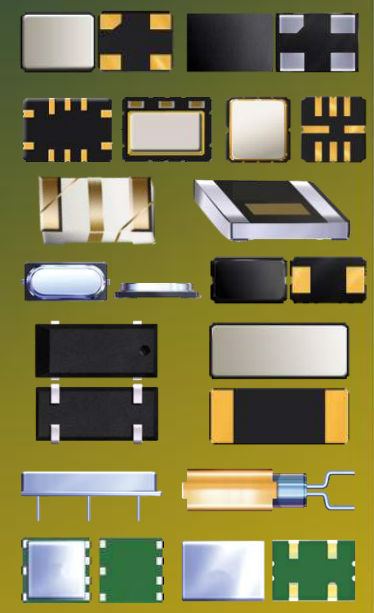

# What is a NFC Antenna?

- NFC antennas are very thin flexible antennas that can be attached inside the cases of mobile phones or NFC readers.
- They are built up from 4 bonded layers; Adhesive Tape, Flexible Printed Circuit (FPC), PET tape, a Ferrite sheet

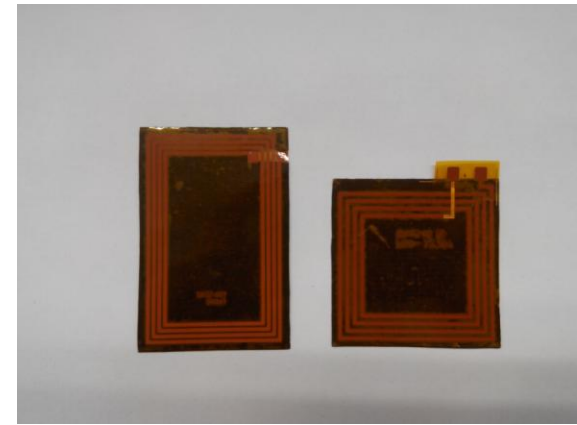

- All layer are bonded together with a total thickness of only 120 ~ 240um or (4 ~ 9 thousandths inch), allowing it to be flexible.
- Since the operating frequency of NFC is 13.56MHz, it's wavelength is large (around 22 meters), too large for dipoles.
- The antenna is formed on the FPC, as a square shaped coil that has inductance (~1.2 to 2.7μH), and its electro-magnetic field (EMF) is used to couple magnetic fields with a second coil in a tag or NFC device.
- The magnetic fields are modulated allowing communication between devices or reader and tag.

A NFC antenna is a FPC with a ferrite backing to concentrate the EMF field produced by the coil. It's not really an antenna in the true sense but utilizes loosely coupled magnetic fields between the NFC coils to allow communication.



# NFC Antenna Matching

## Matching of NFC Antennas

- NFC antennas need to be matched to the driver IC for maximum power transfer at the operating frequency (13.56MHz), between the RF IC and the antenna.
  - The NFC antenna is best tuned when mounted in the application layout. The EMC fields from the antenna can be affected by grounding and proximity to other electronics.
- Designers need to consider several stages of matching the antenna, as shown below:

EMC filter (Low Pass Filter L0 / C0 with a cut-off at 15.4MHz) is used to convert the square wave drive signal from the RFIC to a sine wave.

C1 value (Antenna matching component, to achieve series resonance at 13.56 MHz)

C2 (C2a & C2b Antenna matching component, to achieve parallel resonance at 15MHz)

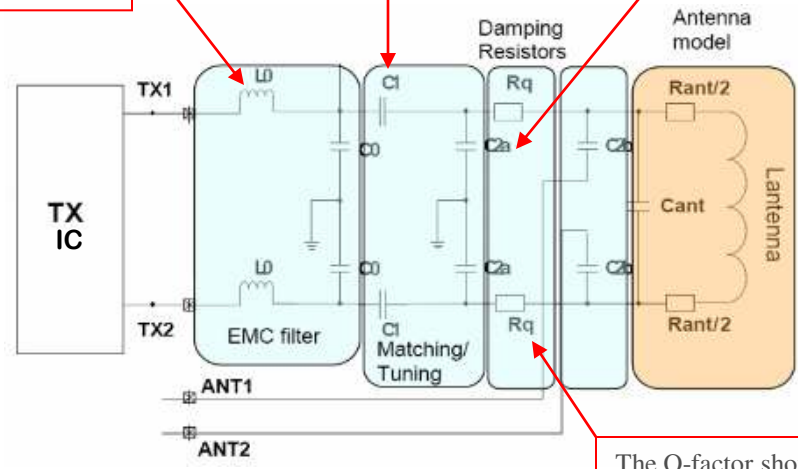

The Q-factor should not exceed 30, (ideally 25 to 30), and is set by the value of Rq.

The diagram above shows the matching between the RFIC IC and NFC antenna; including low pass filter to convert square wave output of IC to sine wave, series to parallel matching and Q damping networks, that optimize the signal to the antenna.

**Crystals**  
**Oscillators**  
**Filters**  
**Precision Timing**  
**Inductors**

**ABRACON CORPORATION**





# Applications using NFC Antennas

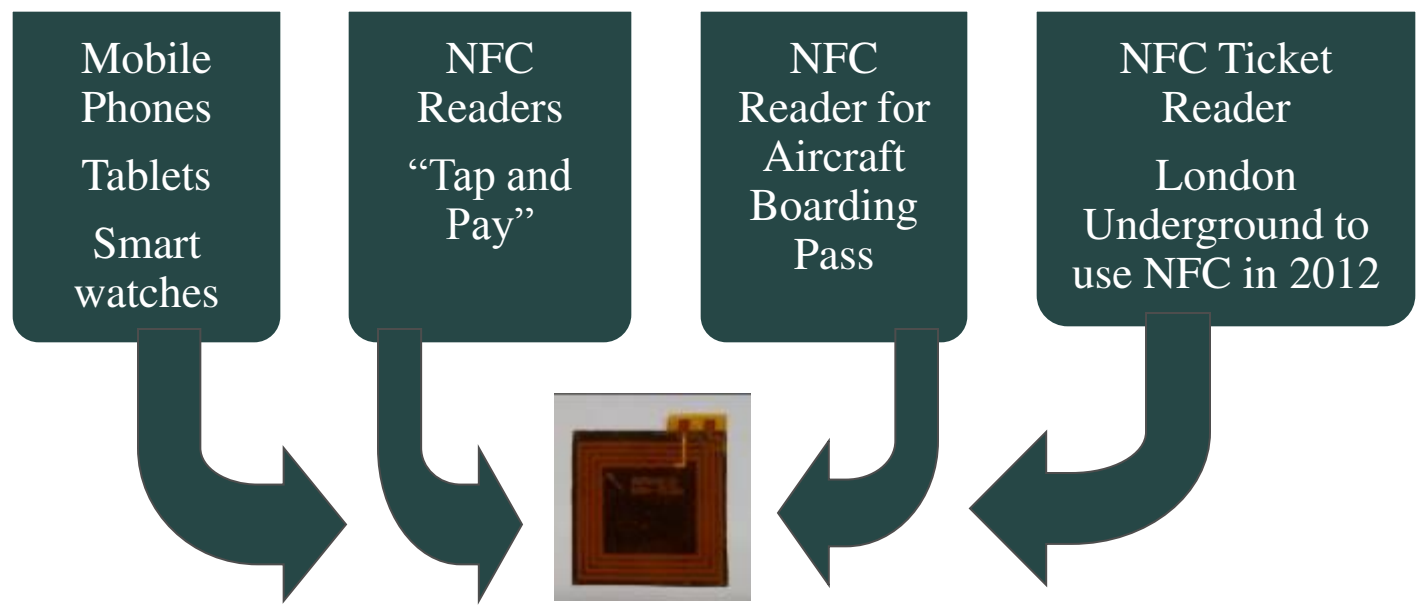

NFC systems are being incorporated into a wider range of equipments. A wide range of mobile phones are incorporating NFC IC's and antennas, allowing them to take advantage of the growing infrastructure of applications that interface with NFC.

Crystals  
Oscillators  
Filters  
Precision Timing  
Inductors





# Applications for NFC Applications

NFC is being incorporated into an increasingly large range of mobile phones and tablet devices. Applications are taking advantage of the NFC growth, incorporating readers into varied applications.

- o Physical Access Readers – Door access
- o Physical Access Credentials – Smart card readers
- o Cashless Payment Readers – Shop payments, Sports Arenas
- o Ticket readers – Airports / Railway Stations
- o Smart Watches
- o NFC Wallets
- o Multi Functional Smart Cards – E.g. SKYSIM
- o Android NFC peer-to-peer sharing applications (demonstrated by Stanford University)
- o TecTiles – Samsung TecTiles
- o Rugged PDA with NFC for industrial use.
- o Peer to Peer links to enable other wireless links like WiFi to enable and control a device, e.g. NFC enabled speaker connection to WiFi.

All of the above applications would have an NFC antenna in the reader or device or both.

The range of equipments and applications where NFC is fitted is growing rapidly. It covers cashless payment systems, smart wallets and ticket readers, but further applications like active museum updates via tags, or using NFC to enable other wireless devices like loudspeakers will become more widespread.

**Crystals  
Oscillators  
Filters  
Precision Timing  
Inductors**

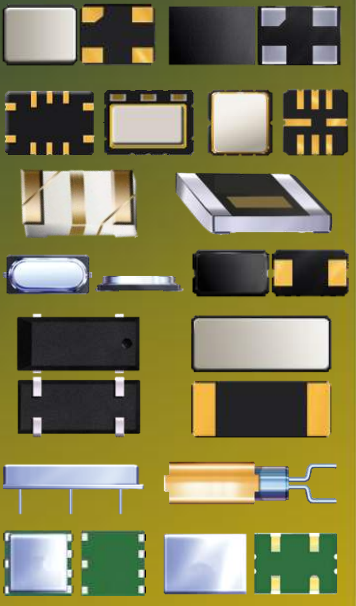



# Major Competitors and Cross Reference

**Crystals  
Oscillators  
Filters  
Precision Timing  
Inductors**

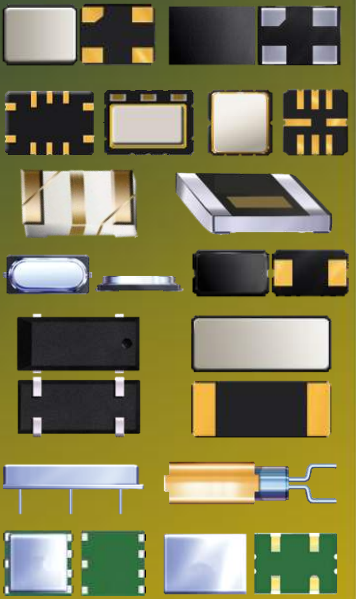

<b>ABRACON</b>	<b>PULSE ELECTRONICS</b>	<b>TAOGLAS LTD</b>
<b>ANFCA-5035-A01</b> (50 X 35mm)	<b>W3579</b> (35 x 50mm)	
	<b>W7015</b> (35 x 50mm)	
	<b>W3580</b> (35 x 50mm)	
<b>ANFCA-6040-A02</b> (60 x 40mm)		<b>FXR.01.07.0100C.A</b> (53 x 36mm)
<b>ANFCA-2525-A02</b> (25 x 25mm)	<b>W7001</b> (25 x 25mm)	

The table summarizes the competitive cross references to the ANFCA series



# Performance Summary ANFCA Series

Part Number	Size	DC Resistance (Max)	Inductance (μH)	Q-Factor
ANFCA-6040-A02	60x40mm	1.0	1.9±10%	40
ANFCA-5040-A02	50x40mm	1.0	1.8±10%	40
ANFCA-5035-A01	50x35mm	1.8	2.7±10%	40
ANFCA-4545-A01	45x45mm	1.0	1.5±10%	40
ANFCA-4535-A01	45x35mm	1.5	1.45±10%	20
ANFCA-4040-A02	40x40mm	1.0	1.7±10%	40
ANFCA-4030-A01	40x30mm	2.0	1.7±10%	40
ANFCA-4030-A02	40x30mm	1.5	1.5±10%	25
ANFCA-3225-A02	32x25mm	1.0	1.8±10%	35
ANFCA-2525-A02	25x25mm	1.0	1.8±10%	35
ANFCA-2515-A02	25x15mm	1.0	1.8±10%	30
ANFCA-1510-A02	15x10mm	1.0	1.8±10%	30

Crystals  
Oscillators  
Filters  
Precision Timing  
Inductors

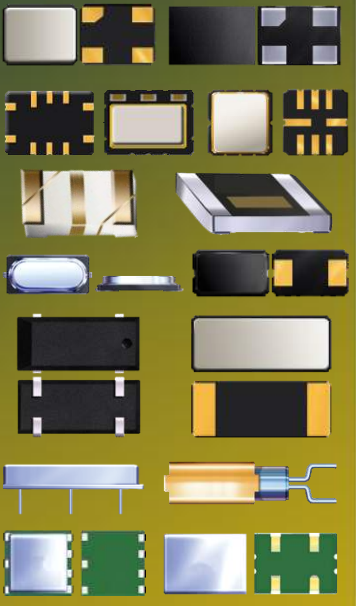

The table summarizes the range of sizes and technical performance of the ANFCA series



# Performance Summary ANFCA Series

## Key Features:

- Ultra thin flexible antenna structure (140 - 240 μm).
- Peel and Stick antenna designs.
- Ferrite backed design that optimizes magnetic fields, increasing the resultant field strength of the antenna.
- Operating temperature range -40C to +85C .
- Matching to leading NFC controller IC's.
- Wide range of sizes and shapes to meet different application designs.
- **Customized solutions available.**
- Competitive price.

Crystals  
Oscillators  
Filters  
Precision Timing  
Inductors

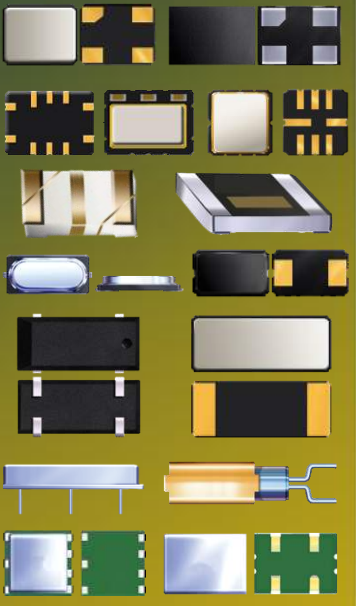

In summary the ANFCA series offers a broad range of ultra thin ferrite sheet, peel and stick NFC antennas that have been matched to leading NFC controller IC's. The wide range of sizes allows designers the ability to match to their equipment, but if this is not suitable customization to fit customer equipments is offered as an option (contact Abracon for details).

Thank You for your Kind Attention

-----

Abracon NFC Antennas