

### Technical Data Sheet Opto Interrupter EAITRDA6

#### Features

- Fast response time
- High analytic
- High sensitivity
- Cut-off visible wavelength  $\lambda_P=940\text{nm}$
- Pb Free
- This product itself will remain within RoHS compliant version.



#### Description

The **EAITRDA6** consists of an infrared emitting diode and an NPN silicon phototransistor, encased oblique angle (45°) on converging optical axis in a black Thermo-plastic housing. The phototransistor receives radiation from the IRED only, and avoids the noise from ambient light.

#### Applications

- Copier
- Scanner
- Non-contact Switching
- For Direct PC Board

### Device Selection Guide

Device No.	Chip Material	LENS COLOR
IR	GaAlAs	Blue
PT	Silicon	Black

### Absolute Maximum Ratings (Ta=25°C)

Parameter		Symbol	Ratings	Unit
Input	Power Dissipation at(or below) 25°C Free Air Temperature	Pd	75	mW
	Reverse Voltage	V <sub>R</sub>	5	V
	Forward Current	I <sub>F</sub>	50	mA
	Peak Forward Current (*1) Pulse width ≤100μs, Duty cycle=1%	I <sub>FP</sub>	1	A
Output	Collector Power Dissipation	P <sub>C</sub>	75	mW
	Collector Current	I <sub>C</sub>	20	mA
	Collector-Emitter Voltage	B V <sub>CEO</sub>	30	V
	Emitter-Collector Voltage	B V <sub>ECO</sub>	5	V
Operating Temperature		T <sub>opr</sub>	-25~+85	°C
Storage Temperature		T <sub>stg</sub>	-40~+85	°C
Lead Soldering Temperature (*2) (1/16 inch form body for 5 seconds)		T <sub>sol</sub>	260	°C

**Notes:** (\*1)  $t_w=100 \mu\text{sec.}$ ,  $T=10 \text{ msec.}$  (\*2)  $t=5 \text{ Sec}$

**Electro-Optical Characteristics (Ta=25°C)**

Parameter		Symbol	Min.	Typ.	Max.	Unit	Condition
Input	Forward Voltage	V <sub>F1</sub>	-	1.2	1.5	V	I <sub>F</sub> =20mA
		V <sub>F2</sub>	-	1.4	1.85		I <sub>F</sub> =100mA
		V <sub>F3</sub>	-	2.6	4.0		I <sub>F</sub> =1A
	Reverse Current	I <sub>R</sub>	-	-	10	μA	V <sub>R</sub> =5V
	Peak Wavelength	λ <sub>P</sub>	-	940	-	nm	I <sub>F</sub> =20mA
Output	Dark Current	I <sub>CEO</sub>	-	-	100	nA	V <sub>CE</sub> =20V, E <sub>e</sub> =0mW/cm <sup>2</sup>
	C-E Saturation Voltage	V <sub>CE(sat)</sub>	-	-	0.4	V	I <sub>C</sub> =2mA, E <sub>e</sub> =1mW/cm
Collector Current(* 3)		I <sub>C(ON)A</sub>	100	-	300	μ A	V <sub>CE</sub> =5V, I <sub>F</sub> =20mA
		I <sub>C(ON)B</sub>	200	-	600	μ A	
		I <sub>C(ON)C</sub>	400	-	1200	μ A	
Response Time	Rise Time	t <sub>R</sub>	-	15	-	μs	V <sub>CE</sub> =5V, I <sub>C</sub> =1mA, R <sub>L</sub> =1KΩ
	Fall Time	t <sub>F</sub>	-	15	-	μs	

Typical Electrical/Optical/Characteristics Curves for IR

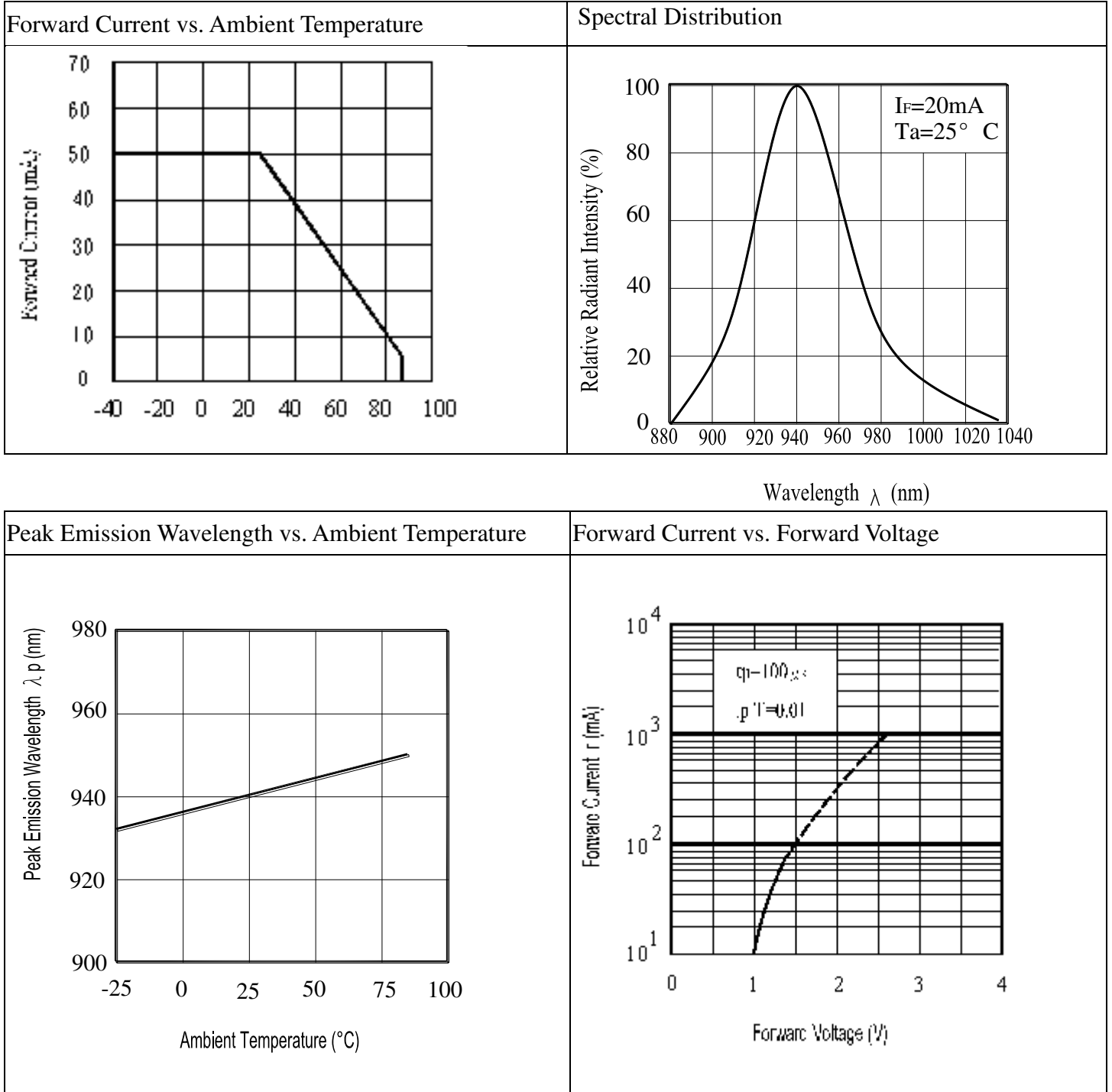

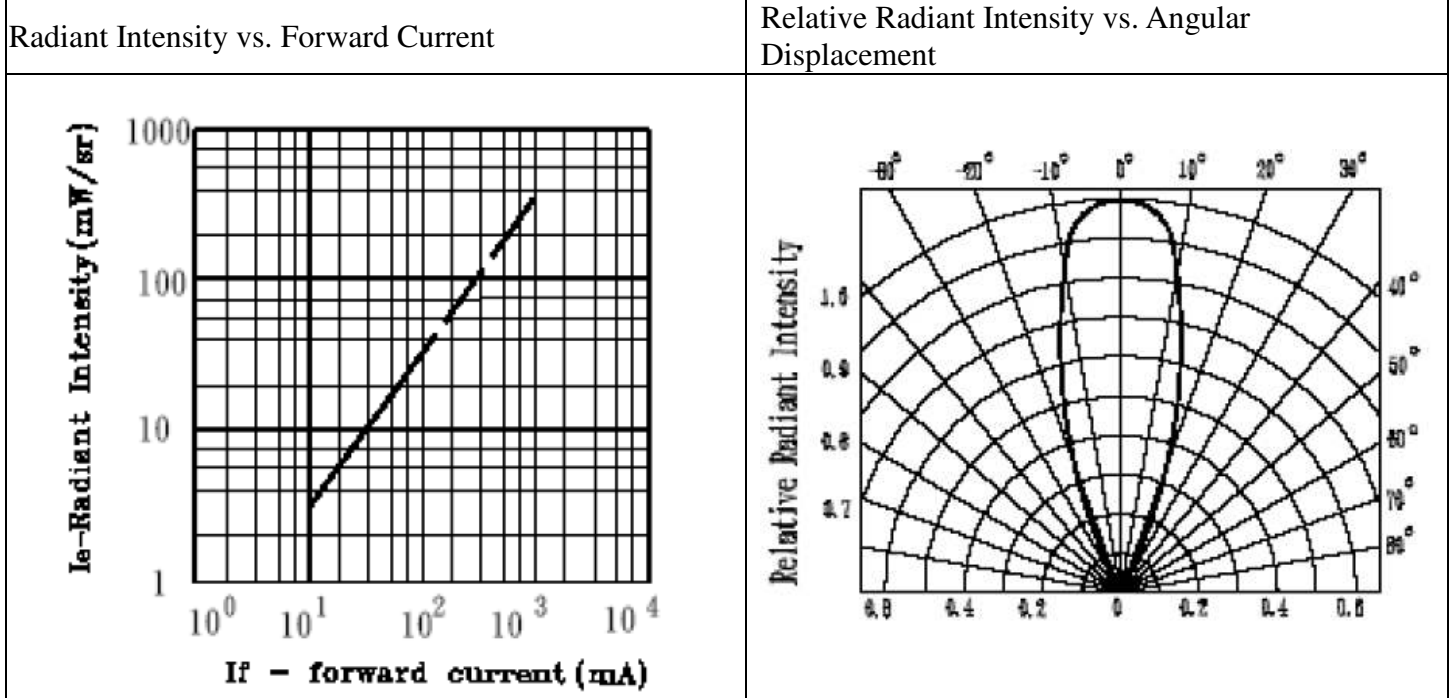

**Typical Electro/Optical/Characteristics Curves for PT**

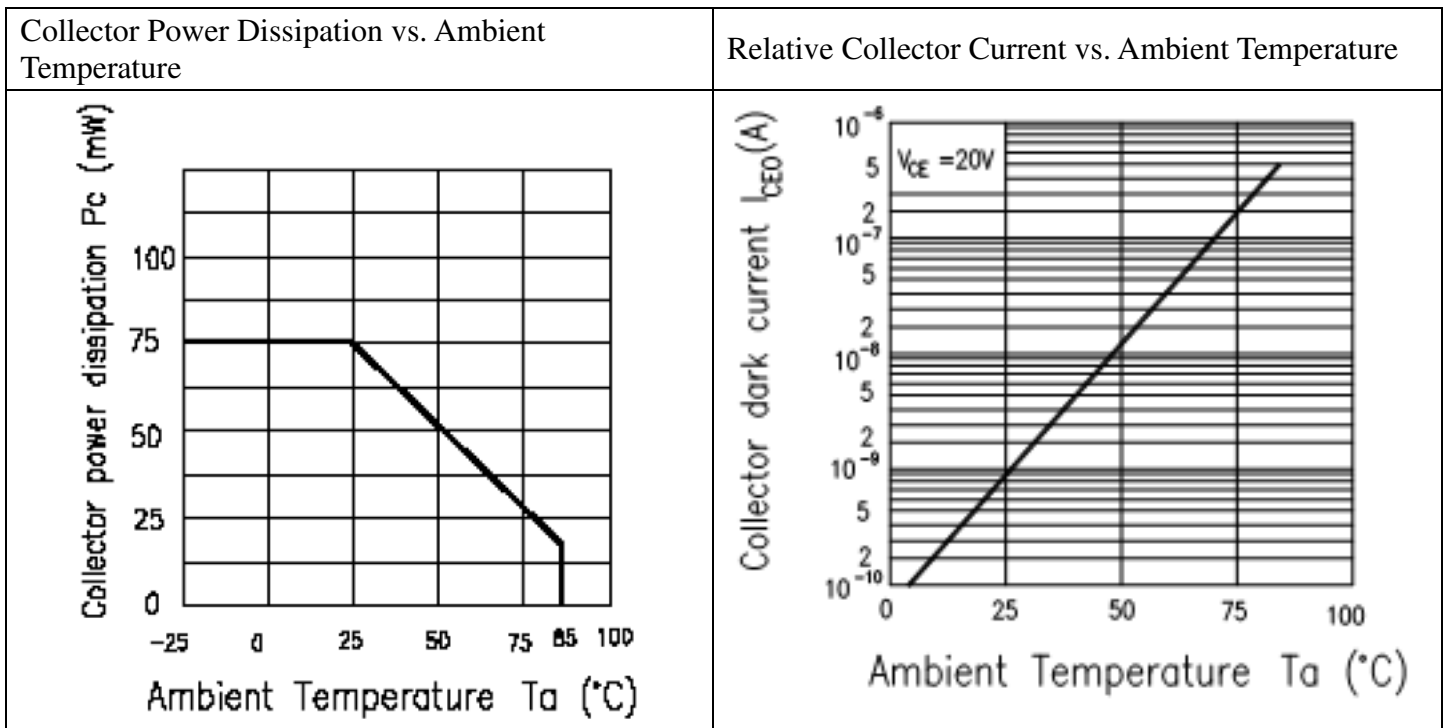

Relative collector current vs. Ambient Temperature

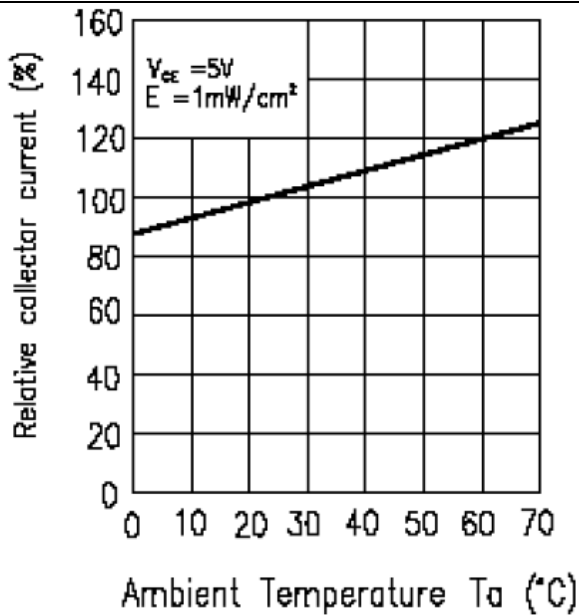

Collector Current vs. Irradiance

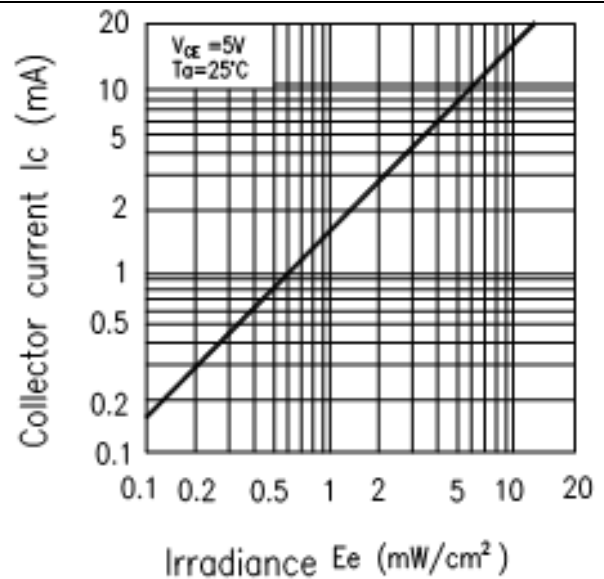

Relative Sensitivity vs. Wavelength

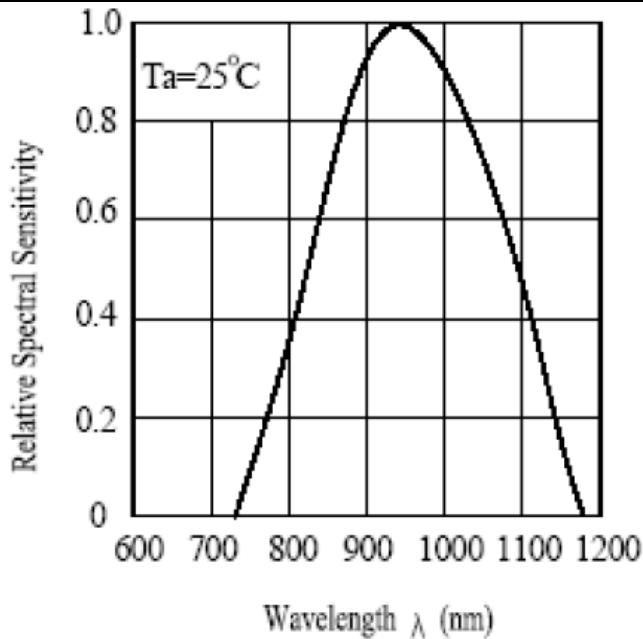

Collector current vs. Collector-Emitter Voltage

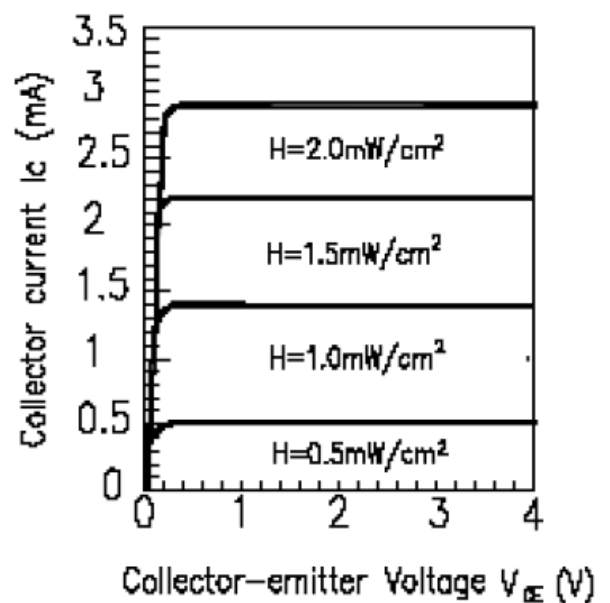

**Reliability Test Item And Condition**

The reliability of products shall be satisfied with items listed below.

Confidence level : 90%

LTPD : 10%

NO.	Item	Test Condition	Test Hours/ Cycle	Sample Size	Failure Judgement Criteria	Ac/Re
1	Solder Heat	TEMP : 260°C ± 5 °C	10 sec	22 PCs	Ic(on) ≤ L×0.8  L :Lower specification limit	0/1
2	Temperature Cycle	H : +100°C 15 mins ↑ 5 min ↓ L : -40°C 15 min	300 cycle	22 PCs		0/1
3	Thermal Shock	H : +100°C 5 min ↑ 10 sec ↓ L : -10°C 5 min	300 cycle	22 PCs		0/1
4	High Temperature Storage	TEMP. : +100°C	1000 hrs	22 PCs		0/1
5	Low Temperature Storage	TEMP. : -40°C	1000 hrs	22 PCs		0/1
6	DC Operating Life	V <sub>CE</sub> =5V I <sub>F</sub> =20mA	1000 hrs	22 PCs		0/1
7	High Temperature / High Humidity	85°C / 85% R.H.	1000 hrs	22 PCs		0/1

**Package Dimension**

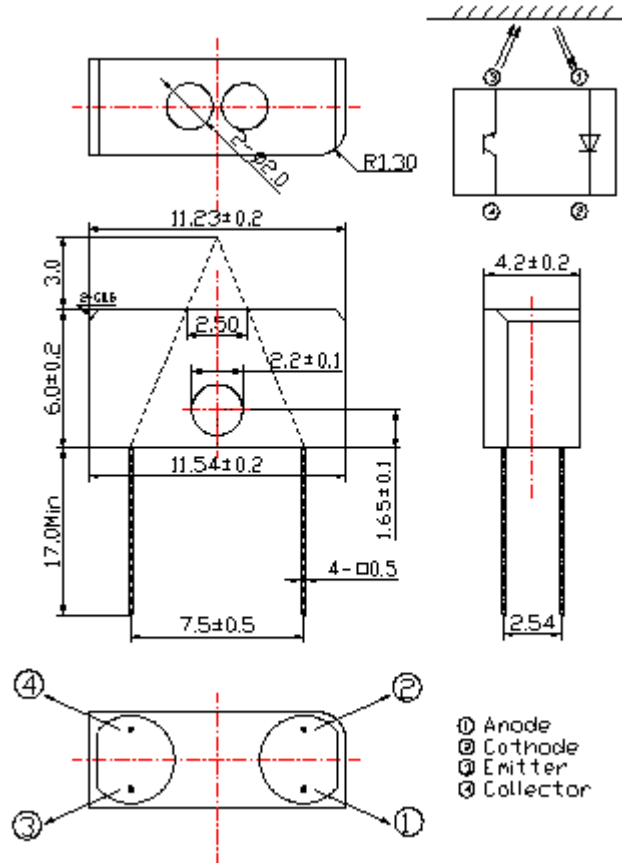

**Notes:**

1. All dimensions are in millimeters
2. Tolerances unless dimensions  $\pm 0.2$  mm
3. Lead spacing is measured where the lead emerge from the package
4. Above specification may be changed without notice. EVERLIGHT Americas will reserve authority on material change for above specification
5. These specification sheets include materials protected under copyright of EVERLIGHT Americas corporation . Please don't reproduce or cause anyone to reproduce them without EVERLIGHT's Americas consent
6. When using this product , please observe the absolute maximum ratings and the instructions for use outlined in these specification sheets. EVERIGHT Americas assumes no responsibility for any damage resulting from use of the product which does not comply with the absolute maximum ratings and the instructions included in these specification sheets.



### Packing Quantity Specification

1. 150 pcs/1bag , 5 bags/1box
2. 10 boxes/1carton

### Label Form Specification

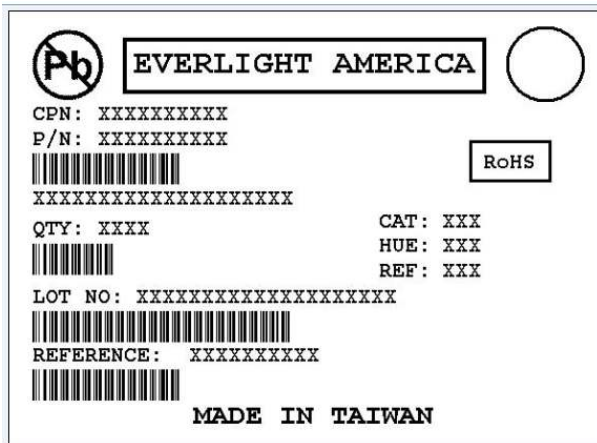

- CPN: Customer's Product Number
- P/N: Product Number
- QTY: Packing Quantity
- CAT: Luminous Intensity Rank
- HUE: Dom. Wavelength Rank
- REF: Forward Voltage Rank
- LOT No: Lot Number
- X: Month
- Reference: Identify Label Number

### Notes

1. Above specification may be changed without notice. EVERLIGHT Americas will reserve authority on material change for above specification.
2. When using this product, please observe the absolute maximum ratings and the instructions for using outlined in these specification sheets. EVERLIGHT Americas assumes no responsibility for any damage resulting from use of the product which does not comply with the absolute maximum ratings and the instructions included in these specification sheets.
3. These specification sheets include materials protected under copyright of EVERLIGHT Americas corporation. Please don't reproduce or cause anyone to reproduce them without EVERLIGHT Americas consent.