

Features

- Wide Bandwidth
- 24 dB Gain
- 20 dBm Output Power
- 30 dBm IP3
- +4V Bias Supply
- Lead-Free 3 mm 16-Lead PQFN Package
- RoHS* Compliant and 260°C Reflow Compatible

Description

The MAAM-011112 is a 4-stage amplifier covering many bands from 20 to 37 GHz with good return losses, high gain, and good linearity. No external matching components are required. This amplifier is internally matched to 50 ohms. The input and output are DC blocked.

The MAAM-011112 primary applications include buffer amplifiers in LO chains and driver amplifiers in transmit lineups for Point-to-Point and Point-to-Multipoint communication systems.

The 3 mm PQFN package has a lead-free finish that is RoHS compliant and compatible with a 260°C reflow temperature. The package also features low lead inductance and an excellent thermal path.

Ordering Information¹

Part Number	Package
MAAM-011112-TR0500	500 piece reel
MAAM-011112-000000	Bulk Packaging
MAAM-011112-000SMB	Sample Board

1. Reference Application Note M513 for reel size information.

Block Diagram

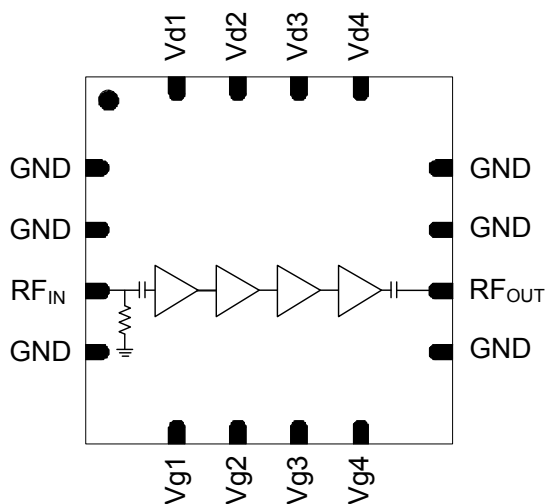

Pin Designations²

Pin	Function	Pin	Function
1	GND	9	GND
2	GND	10	RF _{OUT}
3	RF _{IN}	11	GND
4	GND	12	GND
5	V _{G1}	13	V _{D4}
6	V _{G2}	14	V _{D3}
7	V _{G3}	15	V _{D2}
8	V _{G4}	16	V _{D1}

2. The exposed pad centered on the package bottom must be connected to RF and DC ground.

* Restrictions on Hazardous Substances, European Union Directive 2011/65/EU.

Buffer Amplifier 20 – 37 GHz

Rev. V4

Electrical Specifications:

$T_A = +25^\circ\text{C}$, $V_{DD} = 4.0\text{ V}^3$, $Z_0 = 50\ \Omega$, $I_{D1} = 75\text{ mA}$, $I_{D2} = 35\text{ mA}$, $I_{D3} = 75\text{ mA}$, $I_{D4} = 150\text{ mA}$

Parameter	Units	Min.	Typ.	Max.
Gain	dB	21	24	—
Input Return Loss	dB	—	8	—
Output Return Loss	dB	—	10	—
Output P1dB	dBm	—	18	—
Saturated Power	dBm	—	20	—
Output IP3	dBm	26.5	30	—
Noise Figure	dB	—	6.5	—
Supply Current ($I_{D1} + I_{D2} + I_{D3} + I_{D4}$)	mA	—	335	400
Drain Voltage ($V_{D1,2,3,4}$)	V	—	4.0	—
Gate Voltage ($V_{G1,2,3,4}$)	V	—	-0.3	—

3. Gate voltage must be applied prior to drain voltage. Set V_{G1} , V_{G2} , V_{G3} , V_{G4} , to -1.0V , apply V_{DD} , then adjust V_{G1} , V_{G2} , V_{G3} , V_{G4} to achieve specified current. Typical Current, $335\text{ mA} = 75 (I_{D1}) + 35 (I_{D2}) + 75 (I_{D3}) + 150 (I_{D4})$

Absolute Maximum Ratings ^{4,5}

Parameter	Absolute Maximum
Input Power	0 dBm
Drain Voltage	+4.3 V
Gate Voltage	0 V
Drain Current	500 mA
Storage Temperature	-55°C to $+150^\circ\text{C}$
Operating Temperature	-40°C to $+85^\circ\text{C}$
Junction Temperature	$+150^\circ\text{C}$

- Exceeding any one or combination of these limits may cause permanent damage to this device.
- M/A-COM Technology does not recommend sustained operation near these survivability limits.

Handling Procedures

Please observe the following precautions to avoid damage:

Static Sensitivity

Gallium Arsenide Integrated Circuits are sensitive to electrostatic discharge (ESD) and can be damaged by static electricity. Proper ESD control techniques should be used when handling these Class 1A devices.



Typical Performance Curves

Gain

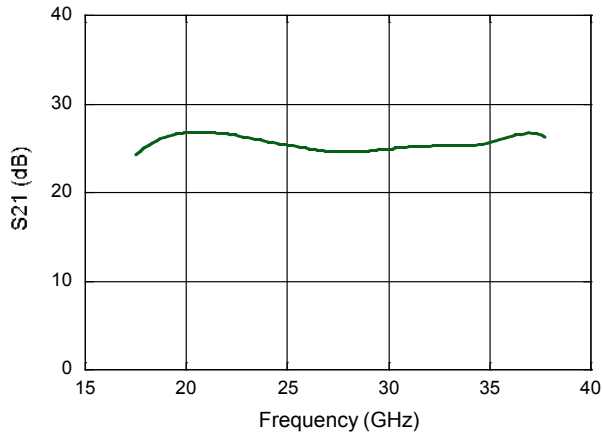

Noise Figure

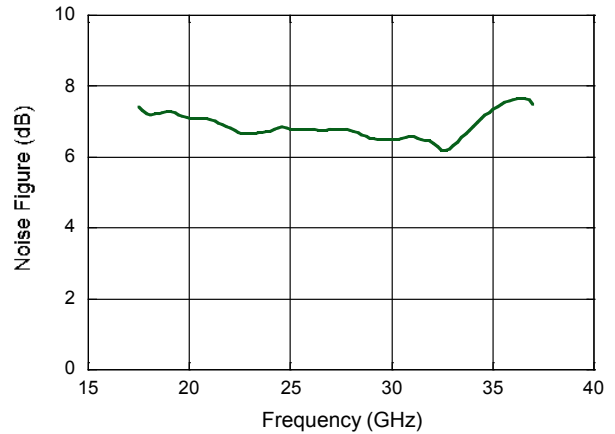

Input Return Loss

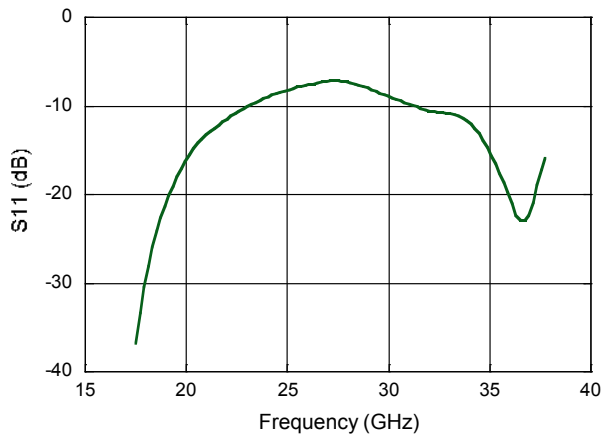

Output Return Loss

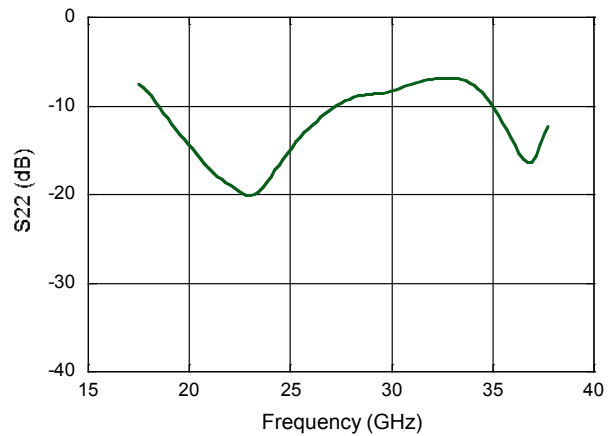

P1dB

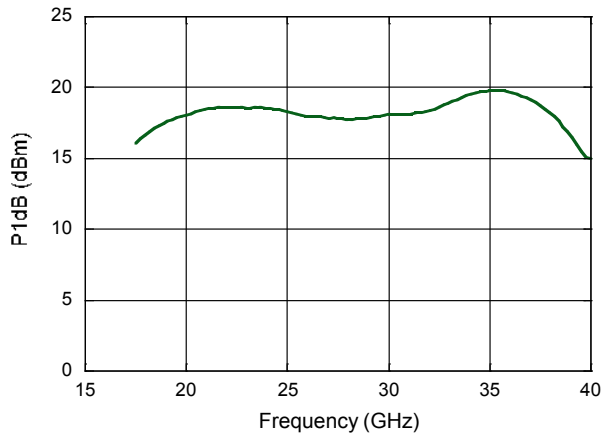

Output IP3

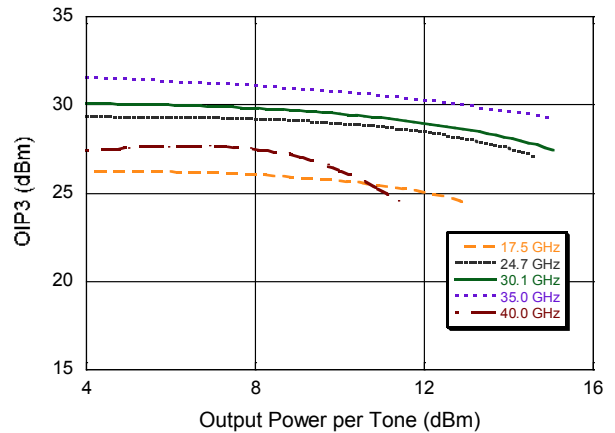

App Note [1] Biasing

As shown in the Pin Designation table, the device is operated by biasing Vd1, Vd2, Vd3 and Vd4 at 4.0 V. The corresponding drain currents are set to 75 mA, 35 mA, 75 mA and 150 mA respectively. It is recommended to use active bias on Vg1, Vg2, Vg3 and Vg4 to keep the currents in Vd1, Vd2, Vd3 and Vd4 constant, in order to maintain the best performance over temperature. Depending on the supply voltages available and the power dissipation constraints, the bias circuits may include a single transistor or a low power operational amplifier, with a low value resistor in series with the drain supply to sense the current. Make sure to sequence the applied voltage to ensure negative gate bias is available before applying the positive drain supply.

Lead-Free 3 mm 16-Lead PQFN[†]

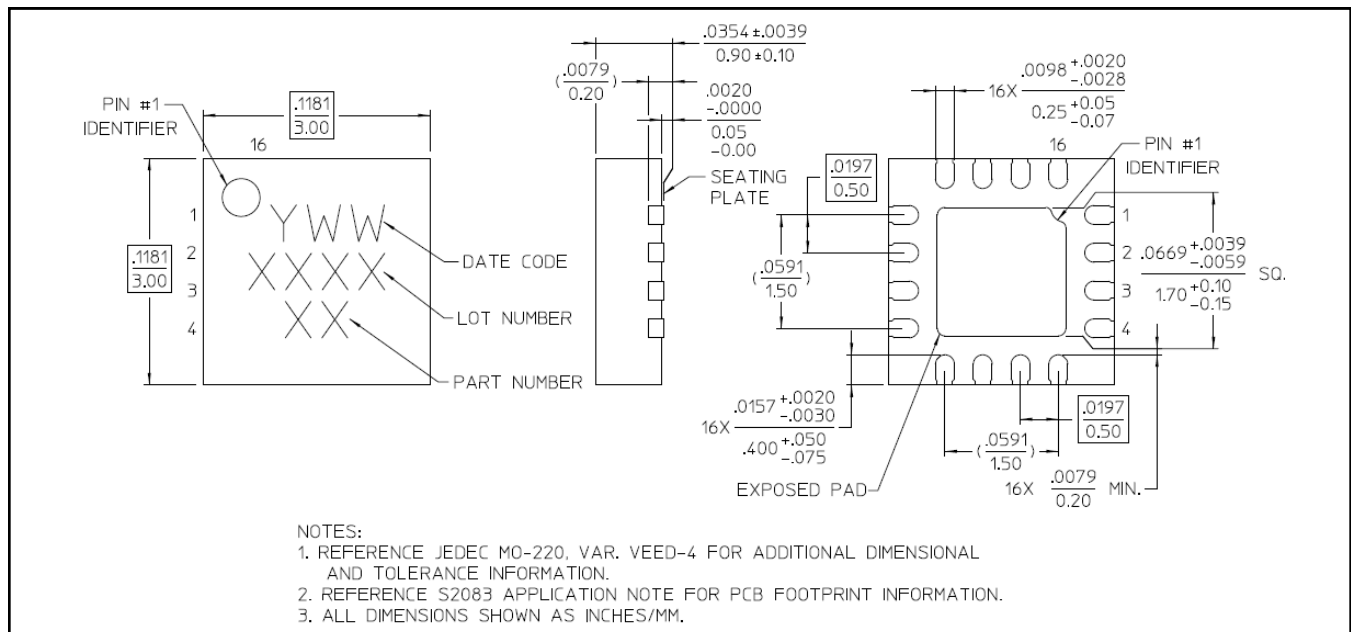

[†] Reference Application Note S2083 for lead-free solder reflow recommendations.
 Meets JEDEC moisture sensitivity level 1 requirements.
 Plating is 100% matte tin plating over copper

M/A-COM Technology Solutions Inc. All rights reserved.

Information in this document is provided in connection with M/A-COM Technology Solutions Inc ("MACOM") products. These materials are provided by MACOM as a service to its customers and may be used for informational purposes only. Except as provided in MACOM's Terms and Conditions of Sale for such products or in any separate agreement related to this document, MACOM assumes no liability whatsoever. MACOM assumes no responsibility for errors or omissions in these materials. MACOM may make changes to specifications and product descriptions at any time, without notice. MACOM makes no commitment to update the information and shall have no responsibility whatsoever for conflicts or incompatibilities arising from future changes to its specifications and product descriptions. No license, express or implied, by estoppels or otherwise, to any intellectual property rights is granted by this document.

THESE MATERIALS ARE PROVIDED "AS IS" WITHOUT WARRANTY OF ANY KIND, EITHER EXPRESS OR IMPLIED, RELATING TO SALE AND/OR USE OF MACOM PRODUCTS INCLUDING LIABILITY OR WARRANTIES RELATING TO FITNESS FOR A PARTICULAR PURPOSE, CONSEQUENTIAL OR INCIDENTAL DAMAGES, MERCHANTABILITY, OR INFRINGEMENT OF ANY PATENT, COPYRIGHT OR OTHER INTELLECTUAL PROPERTY RIGHT. MACOM FURTHER DOES NOT WARRANT THE ACCURACY OR COMPLETENESS OF THE INFORMATION, TEXT, GRAPHICS OR OTHER ITEMS CONTAINED WITHIN THESE MATERIALS. MACOM SHALL NOT BE LIABLE FOR ANY SPECIAL, INDIRECT, INCIDENTAL, OR CONSEQUENTIAL DAMAGES, INCLUDING WITHOUT LIMITATION, LOST REVENUES OR LOST PROFITS, WHICH MAY RESULT FROM THE USE OF THESE MATERIALS.

MACOM products are not intended for use in medical, lifesaving or life sustaining applications. MACOM customers using or selling MACOM products for use in such applications do so at their own risk and agree to fully indemnify MACOM for any damages resulting from such improper use or sale.