

# Three Phase Rectifier Bridge

$I_{dAV} = 25 \text{ A}$   
 $V_{RRM} = 800-1800 \text{ V}$

$V_{RSM}$ $V_{DSM}$ V	$V_{RRM}$ $V_{DRM}$ V	Type
900	800	VUO 25-08NO8
1300	1200	VUO 25-12NO8
1500	1400	VUO 25-14NO8
1700	1600	VUO 25-16NO8
1900	1800	VUO 25-18NO8

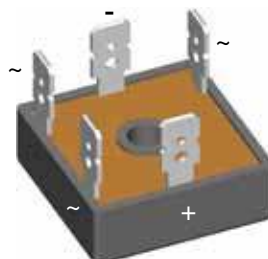
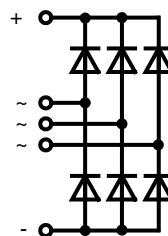

Symbol	Conditions	Maximum Ratings	
$I_{dAV}$	$T_C = 85^\circ\text{C}$ , module	20	A
$I_{dAVM}$	$T_C = 63^\circ\text{C}$ , module	25	A
$I_{FSM}$	$T_{VJ} = 45^\circ\text{C}$ ; $t = 10 \text{ ms}$ (50 Hz)	380	A
	$V_R = 0$ ; $t = 8.3 \text{ ms}$ (60 Hz)	400	A
	$T_{VJ} = T_{VJM}$ ; $t = 10 \text{ ms}$ (50 Hz)	360	A
	$V_R = 0$ ; $t = 8.3 \text{ ms}$ (60 Hz)	400	A
$I^2t$	$T_{VJ} = 45^\circ\text{C}$ ; $t = 10 \text{ ms}$ (50 Hz)	725	A <sup>2</sup> s
	$V_R = 0$ ; $t = 8.3 \text{ ms}$ (60 Hz)	750	A <sup>2</sup> s
	$T_{VJ} = T_{VJM}$ ; $t = 10 \text{ ms}$ (50 Hz)	650	A <sup>2</sup> s
	$V_R = 0$ ; $t = 8.3 \text{ ms}$ (60 Hz)	650	A <sup>2</sup> s
$T_{VJ}$		-40...+150	°C
$T_{VJM}$		150	°C
$T_{stg}$		-40...+150	°C
$V_{ISOL}$	50/60 Hz, RMS $t = 1 \text{ min}$	2500	V~
	$I_{ISOL} \leq 1 \text{ mA}$ $t = 1 \text{ s}$	3000	V~
$M_d$	Mounting torque (M5) (10-32 UNF)	2 ±10%	Nm
		18 ±10%	lb.in.
<b>Weight</b>	Typ.	22	g

## Features

- Package with ¼" fast-on terminals
- Isolation voltage 3000 V~
- Planar passivated chips
- Blocking voltage up to 1800 V
- Low forward voltage drop
- UL registered E 72873

## Applications

- Supplies for DC power equipment
- Input rectifiers for PWM inverter
- Battery DC power supplies
- Field supply for DC motors

## Advantages

- Easy to mount with one screw
- Space and weight savings
- Improved temperature & power cycling

## Dimensions in mm (1 mm = 0.0394")

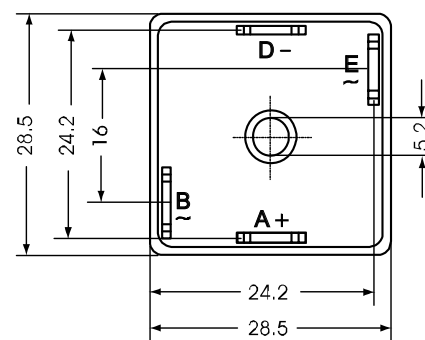
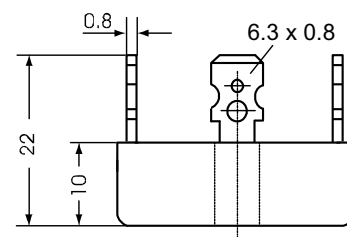

Symbol	Conditions	Characteristic Values	
$I_R$	$V_R = V_{RRM}$ $T_{VJ} = 25^\circ\text{C}$ $T_{VJ} = T_{VJM}$	0.3	mA
		5.0	mA
$V_F$	$I_F = 150 \text{ A}$ $T_{VJ} = 25^\circ\text{C}$	2.2	V
$V_{TO}$	For power-loss calculations only	0.85	V
$r_t$		12	mΩ
$R_{thJC}$	per diode; 120° el.	9.30	K/W
	per module	1.55	K/W
$R_{thJH}$	per diode; 120° el.	10.20	K/W
	per module	1.70	K/W
$d_S$	Creeping distance on surface	12.7	mm
$d_A$	Creepage distance in air	9.4	mm
$a$	Max. allowable acceleration	50	m/s <sup>2</sup>

Data according to IEC 60747 and refer to a single diode unless otherwise stated.

IXYS reserves the right to change limits, test conditions and dimensions.

20100303a

© IXYS All rights reserved

1 - 2

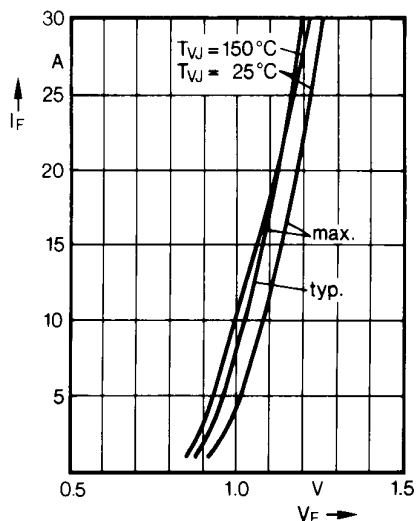

Fig. 1 Forward current versus voltage drop per diode

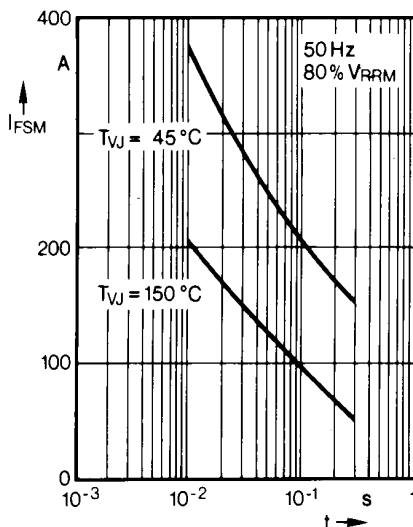

Fig. 2 Surge overload current per diode  
 $I_{FSM}$ : Crest value.  $t$ : duration

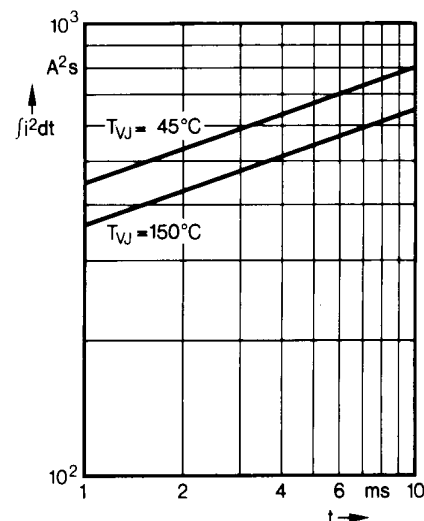

Fig. 3  $I^2t$  versus time (1-10 ms) per diode

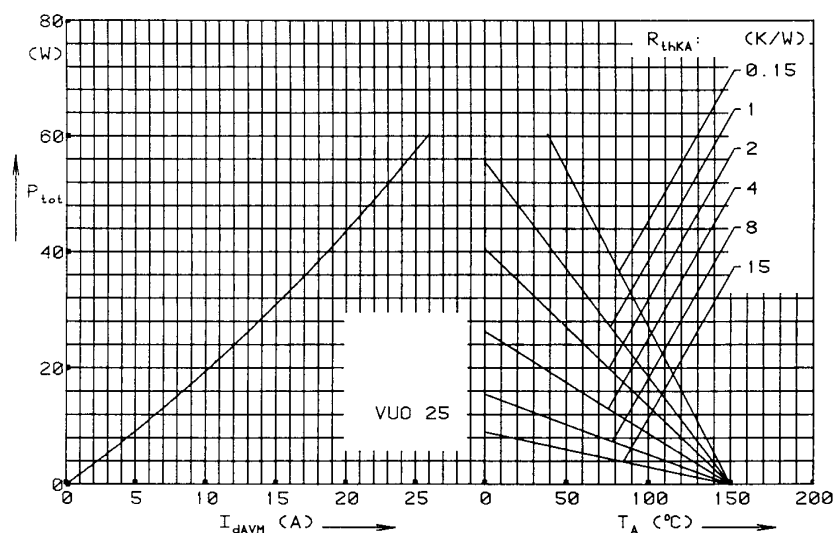

Fig. 4 Power dissipation versus direct output current and ambient temperature

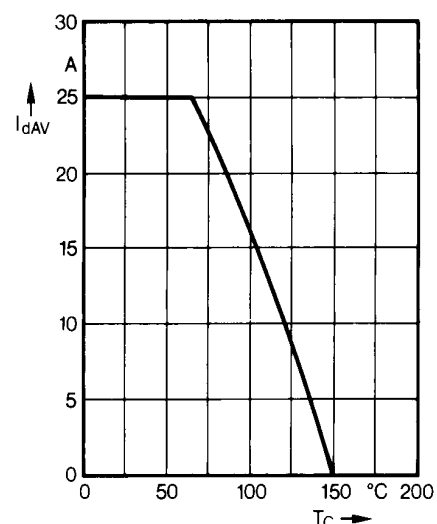

Fig. 5 Maximum forward current at case temperature

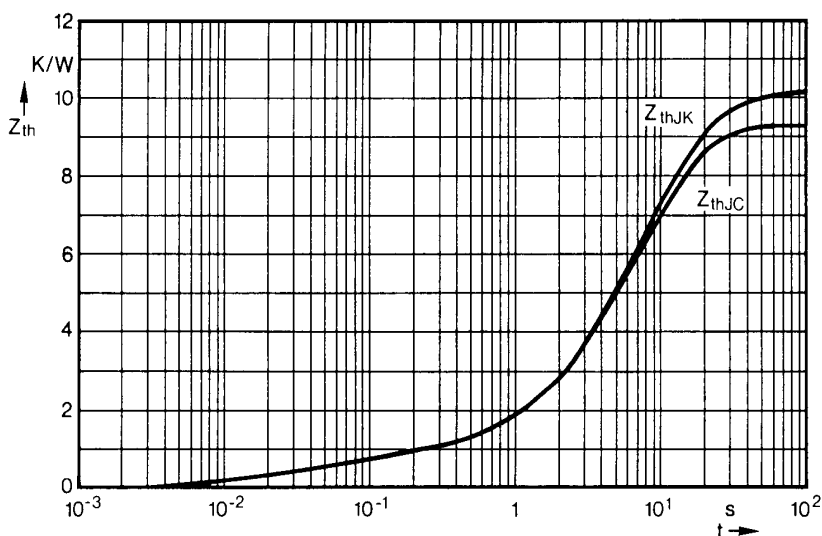

Fig. 6 Transient thermal impedance per diode

Constants for  $Z_{thJC}$  calculation:

i	$R_{thi}$ (K/W)	$t_i$ (s)
1	0.194	0.024
2	0.556	0.07
3	2.25	5.8
4	6.3	8.5

Constants for  $Z_{thJK}$  calculation:

i	$R_{thi}$ (K/W)	$t_i$ (s)
1	0.194	0.024
2	0.556	0.07
3	2.25	5.8
4	6.3	8.5
5	0.9	28