

Ultra Small, Low-Input Voltage, Low R_{ON} Load Switch

Features

- Integrated Load Switch
- Input Voltage: 0.75-V to 3.6-V
- Ultra-Low ON Resistance:
 - Max R_{ON} over temperature = 9.8m Ω at $V_{IN} = 3.6V$
- Ultra Small CSP-8 package
 - 0.95 mm x 1.95 mm, 0.5-mm Pitch
- 4-A Maximum Continuous Switch Current
- Shutdown Current 5.5- μ A max
- Low Threshold Control Input
- Controlled Slew Rate to Avoid Inrush Currents
- Quick Output Discharge Transistor
- ESD Performance Tested Per JESD 22
 - 4000-V Human-Body Model (A114-B, Class II)
 - 1000-V Charged-Device Model (C101)

Applications

- Notebook / Netbook Computer
- Tablet PC
- PDAs / Smartphones
- GPS Navigation Devices
- MP3 Players

Description

The PI3PD22919 is a small, ultra-low r_{ON} load switch with controlled turn on. The device contains a N-channel MOSFET that can operate over an input voltage range of 0.75 V to 3.6 V and switch currents up to 4-A. An integrated charge pump biases the NMOS switch in order to achieve a minimum switch ON resistance (r_{ON}). The switch is controlled by an on/off input (\overline{ON}), via an active low enable pin.

The PI3PD22919 has a 1250 Ω on-chip load resistor for quick output discharge when the switch is turned off.

The PI3D22919 has an internally controlled rise time in order to reduce inrush current. The PI3D22919 features a rise time of 880 μ S at 3.6V.

The PI3D22919 is available in an ultra-small, space-saving 8-pin CSP package and is characterized for operation over the free-air temperature range of -40°C to 85°C.

Pin Configuration (Bottom View)

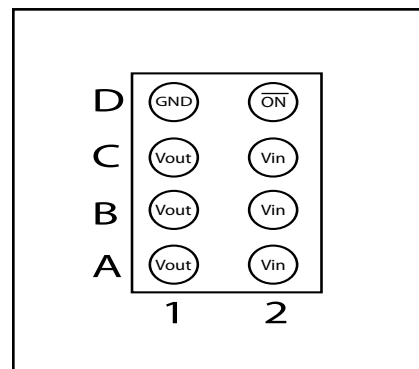

Functional Block Diagram

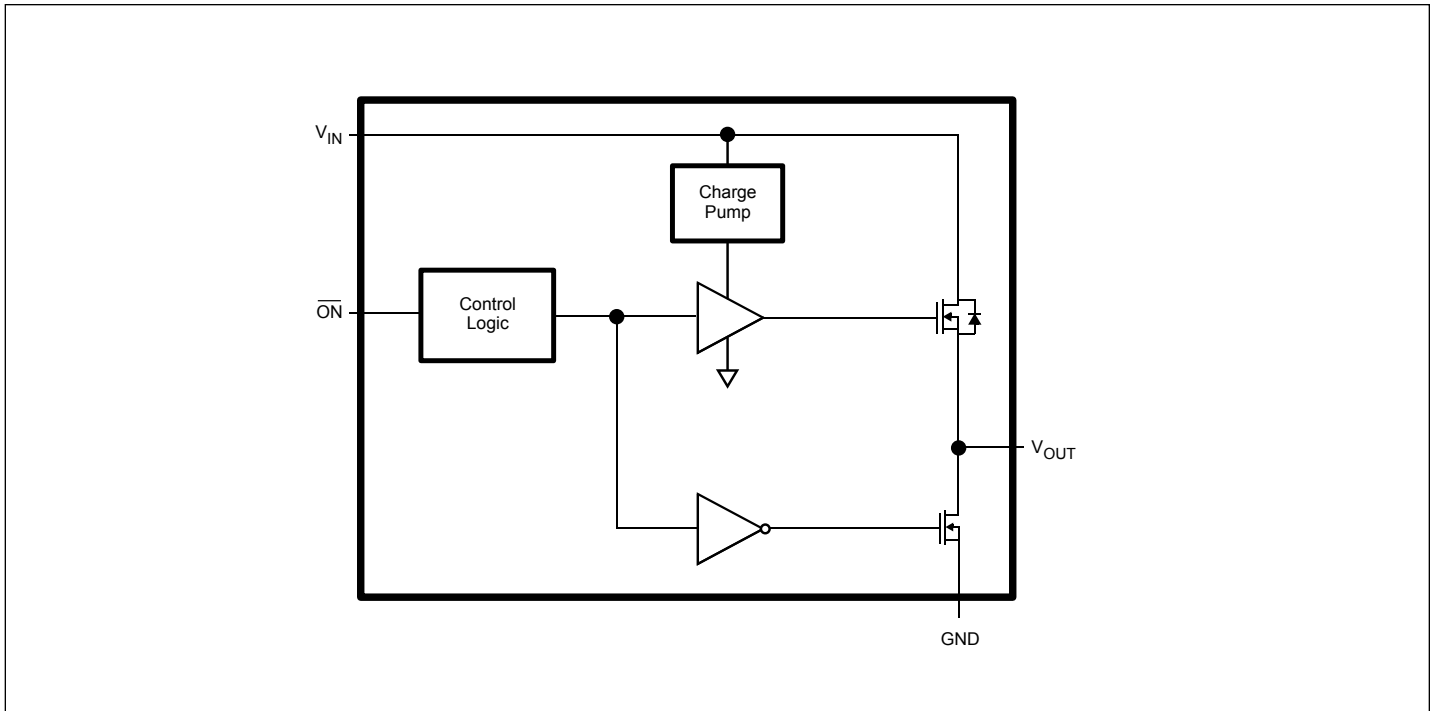

Function Table

\overline{ON} (Control Input)	V_{IN} to V_{OUT}	V_{OUT} to GND
L	ON	OFF
H	OFF	ON

Pin Description

Terminal		Description
Ball No.	Name	
D1	GND	Ground
D2	\overline{ON}	Switch Control Input. Active low, do not leave floating.
A1, B1, C1	V_{OUT}	Switch Output
A2, B2, C2	V_{IN}	Switch Input. Bypass this input with a ceramic capacitor to ground.

Absolute Maximum Ratings

V_{IN} , Input voltage range.....	-0.3V to 4V
V_{OUT} , Output voltage range.....	$V_{IN}+0.3V$
V_{ON} , Input voltage range.....	-0.3V to 4V
I_{MAX} , Maximum continuous switch current.....	4A
I_{PLS} , Maximum pulsed current (100- μ s pulse, 2% duty cycle).....	6A
T_A , Operating free-air temperature range	-40°C to 85 °C
T_J , Maximum junction temperature.....	125 °C
T_{STG} , Storage temperature range.....	-65°C to 150 °C
T_{LEAD} , Maximum lead temperature(10-s soldering time).....	300 °C
ESD, Electrostatic discharge protection , Charged Device Model(CDM).....	1000V
Human-Body Model(HBM).....	4000V

Note:

Stresses beyond those listed under absolute maximum ratings may cause permanent damage to the device. These are stress ratings only, and functional operation of the device at these or any other conditions beyond those indicated under Recommended Operating Conditions is not implied. Exposure to absolute-maximum-rated conditions for extended periods may affect device reliability.

Recommended Operating Conditions

Symbol	Parameter	Min.	Max.	Unit	
V_{IN}	Input voltage range	0.75	3.6	V	
V_{OUT}	Output voltage range		V_{IN}	V	
V_{IH}	High-level input voltage range, ON	$V_{IN} = 2.5\text{ V to }3.6\text{ V}$	1.2	3.6	V
		$V_{IN} = 0.75\text{ V to }2.5\text{ V}$	0.9	3.6	V
V_{IL}	Low-level input voltage range, ON	$V_{IN} = 2.5\text{ V to }3.6\text{ V}$		0.6	V
		$V_{IN} = 0.75\text{ V to }2.49\text{ V}$		0.4	V
C_{IN}	Input capacitor	1 ⁽¹⁾		μ F	

DC Electrical Characteristics Unless otherwise specified, V_{IN} = 0.75V to 3.6V

Parameter	Conditions	T _A ¹	Min.	Typ.	Max.	Unit	
Power Switch							
I _{IN}	Quiescent current	I _{OUT} = 0, V _{ON} = GND	Full		68	160	μA
					40	70	
					25	350	
					103	200	
					78	110	
					37	70	
I _{IN(LEAKAGE)}	OFF-state supply current	V _{IN} = V _{ON} = 3.6V, V _{OUT} = 0	Full		5.5	μA	
R _{ON}	ON-state resistance	I _{OUT} = -200 mA	25°C	Full	7.1	8.8	mΩ
					9.8		
			25°C	Full	7.2	8.9	
					9.9		
			25°C	Full	7.3	9.1	
					10.1		
			25°C	Full	6.9	9.1	
					10.4		
			25°C	Full	7	9.2	
					10.6		
			25°C	Full	7.6	10.2	
					11.6		
r _{PD}	Output pulldown resistance	V _{IN} = V _{ON} = 3.3V, I _{OUT} = 3mA	Full		1250	1500	Ω
I _{ON}	ON input leakage current	V _{ON} = 0.9V to 3.6 V or GND	Full		0.1	μA	

Note:

1. Typical values are at V_{IN} = 3.3 V and T_A = 25°C.
2. See Output Pulldown in Application Information.

Switching Characteristics

Symbol	Parameter	Conditions			Min.	Typ.	Max.	Units
V_{IN} = 3.6V, T_A = 25°C (Unless otherwise specified)								
t _{ON}	Turn-ON time	R _L = 10Ω	C _L = 0.1μF	V _{IN} = 3.6V		970		μs
t _{OFF}	Turn-OFF time					3		μs
t _r	V _{OUT} rise time					880		μs
t _f	V _{OUT} fall time					2		μs
V_{IN} = 0.9V, T_A = 25°C (Unless otherwise specified)								
t _{ON}	Turn-ON time	R _L = 10Ω	C _L = 0.1μF	V _{IN} = 0.9V		840		μs
t _{OFF}	Turn-OFF time					16		μs
t _r	V _{OUT} rise time					470		μs
t _f	V _{OUT} fall time					5		μs

Parameter Measurement Information

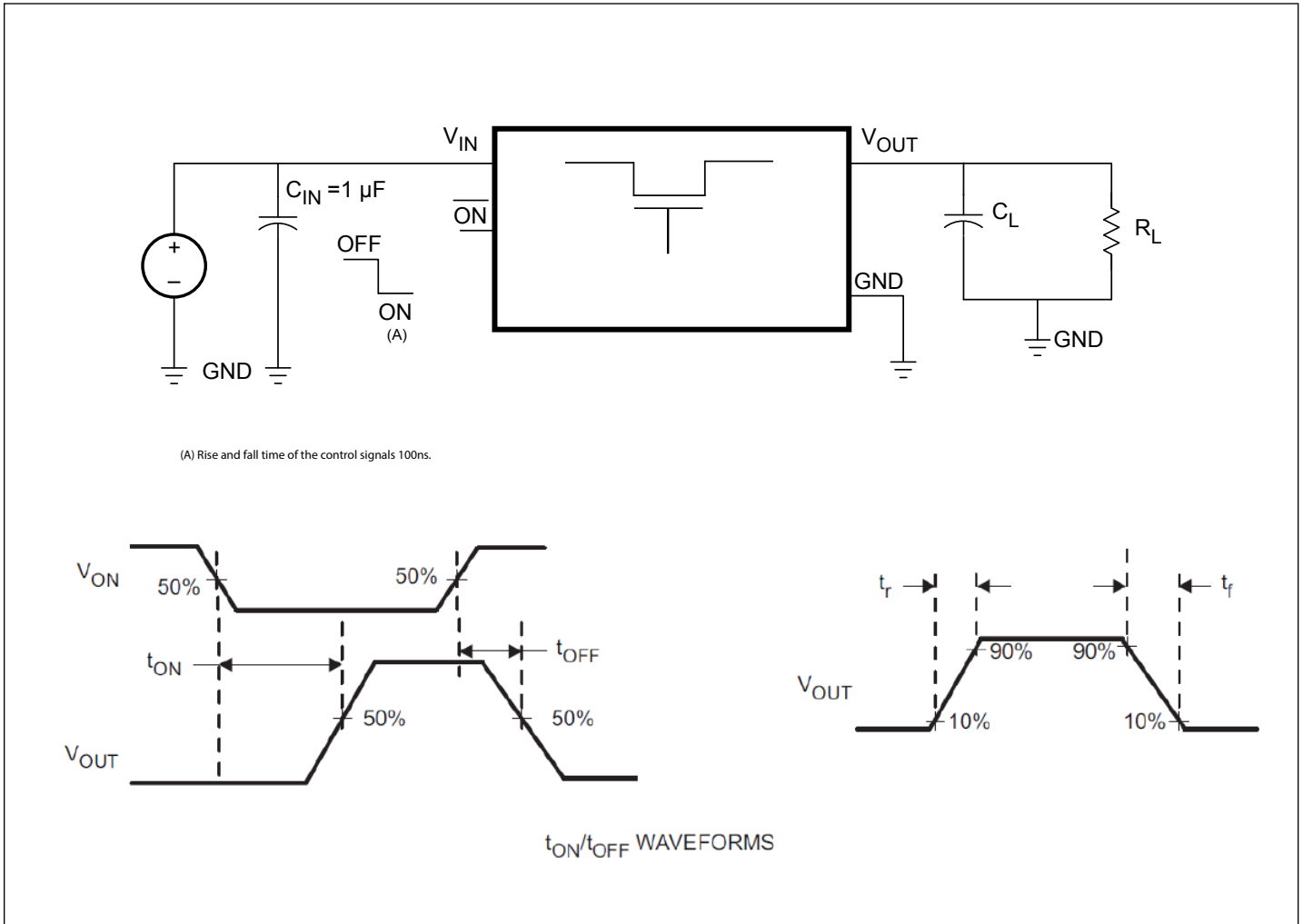

Typical Characteristics

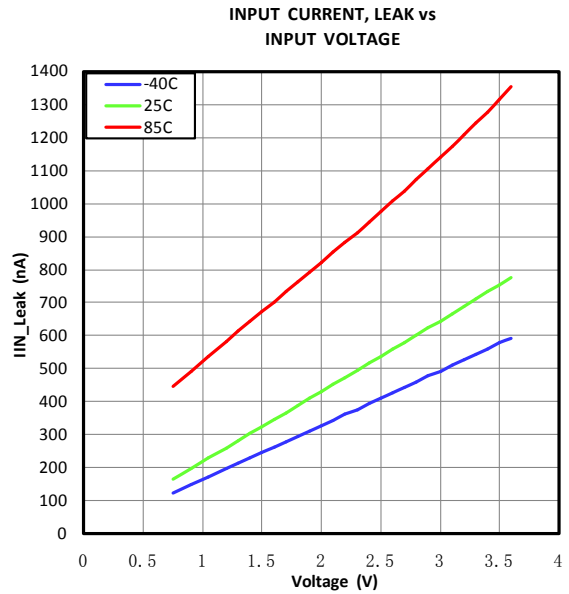
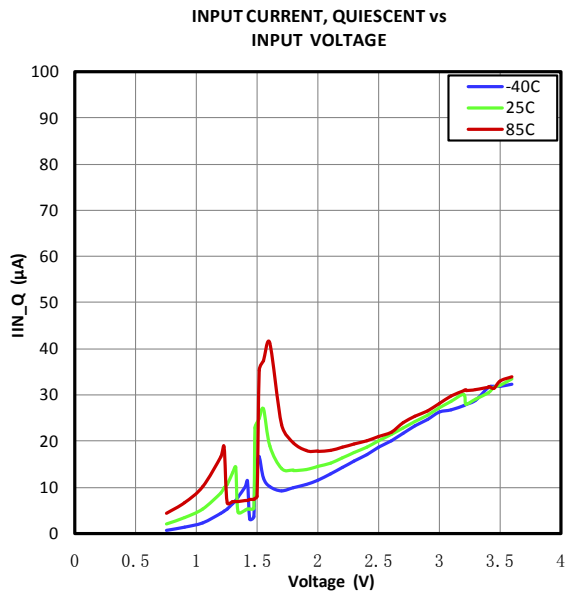
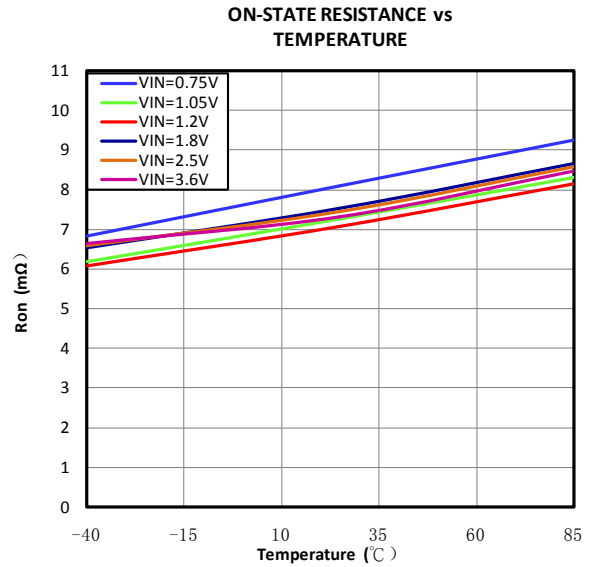
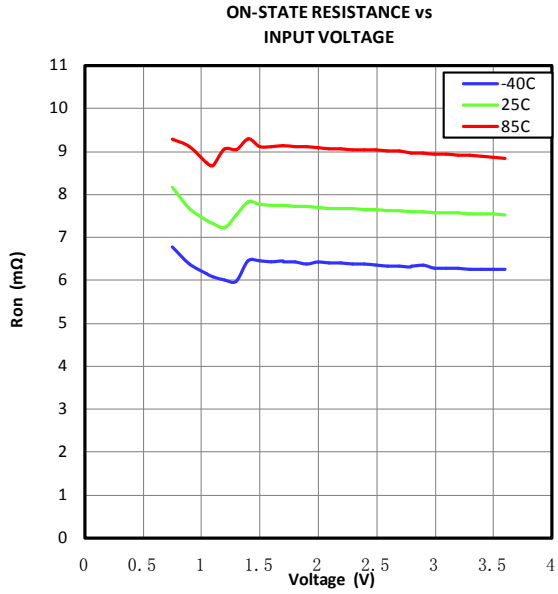

ON INPUT THRESHOLD

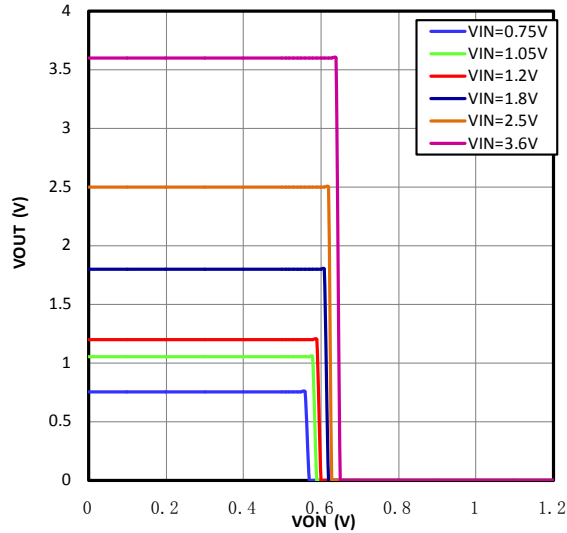

TURN-ON TIME vs TEMPERATURE

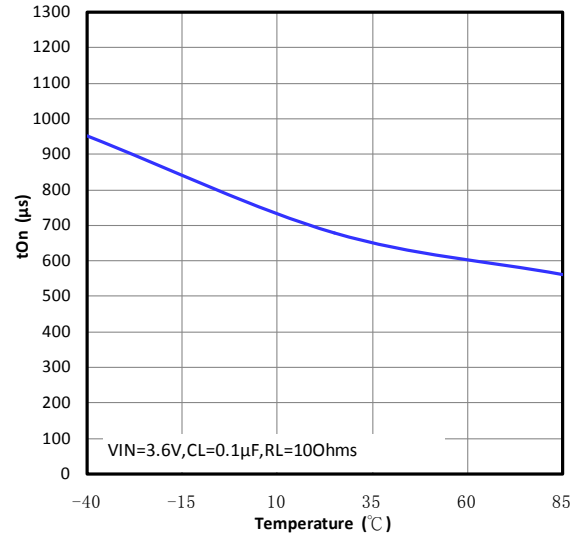

TURN-OFF TIME vs TEMPERATURE

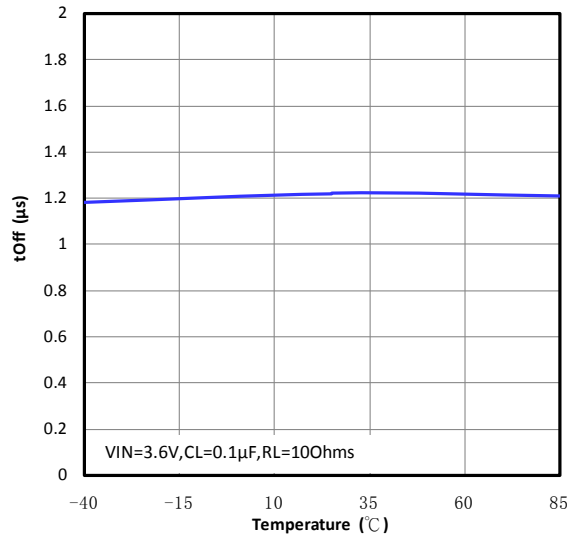

RISE TIME vs TEMPERATURE

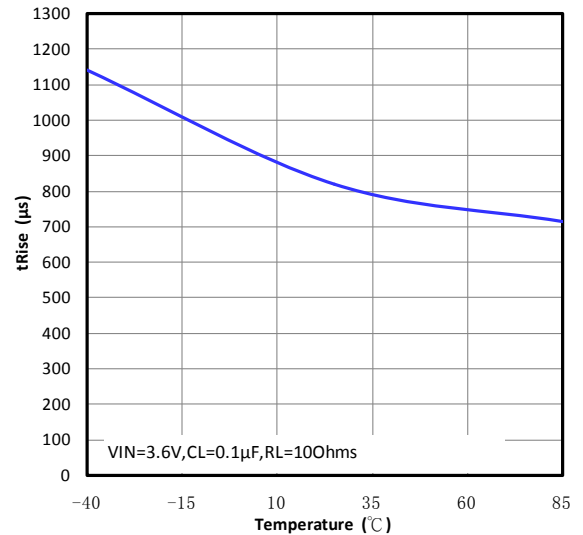

FALL TIME vs TEMPERATURE

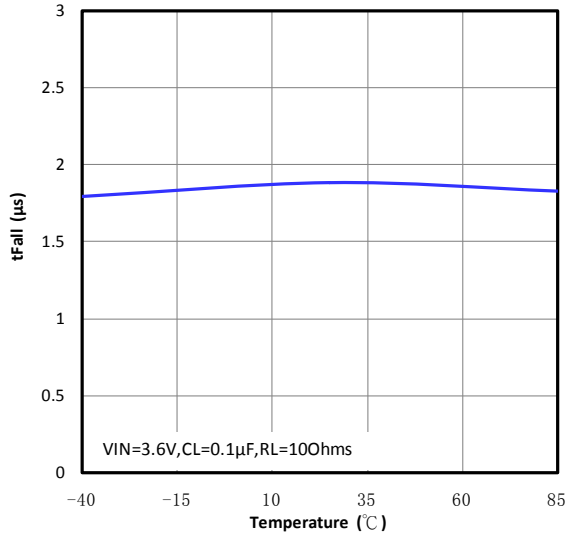

TURN-ON TIME vs TEMPERATURE

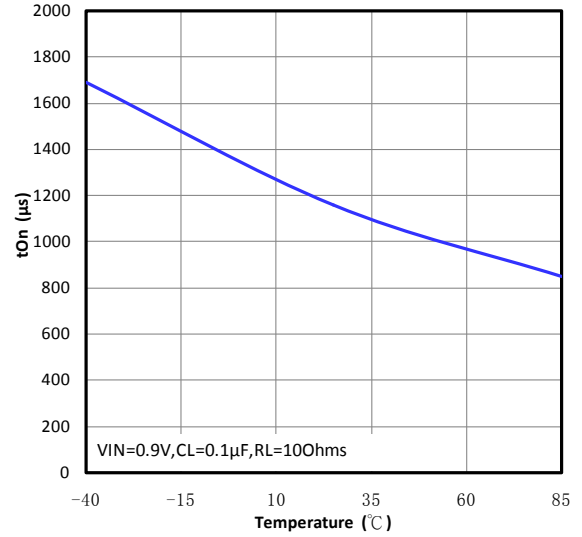

TURN-OFF TIME vs TEMPERATURE

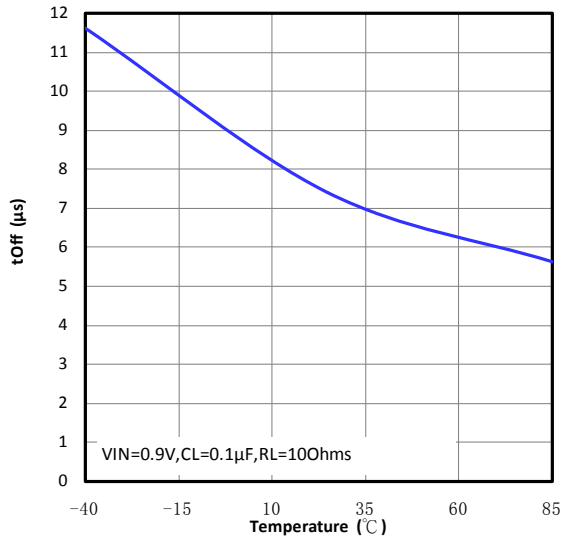

RISE TIME vs TEMPERATURE

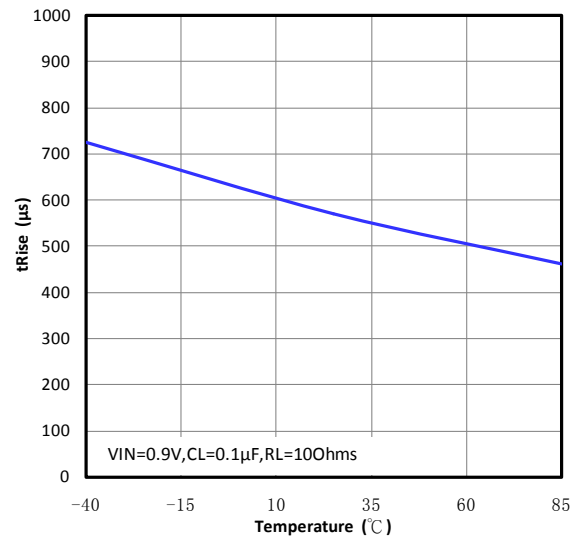

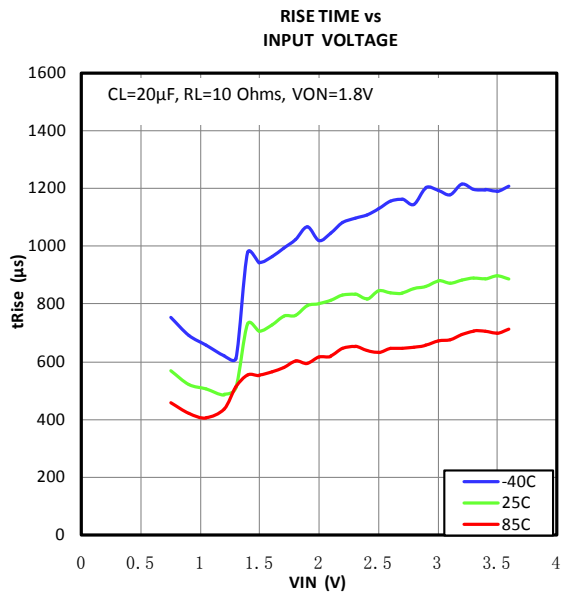
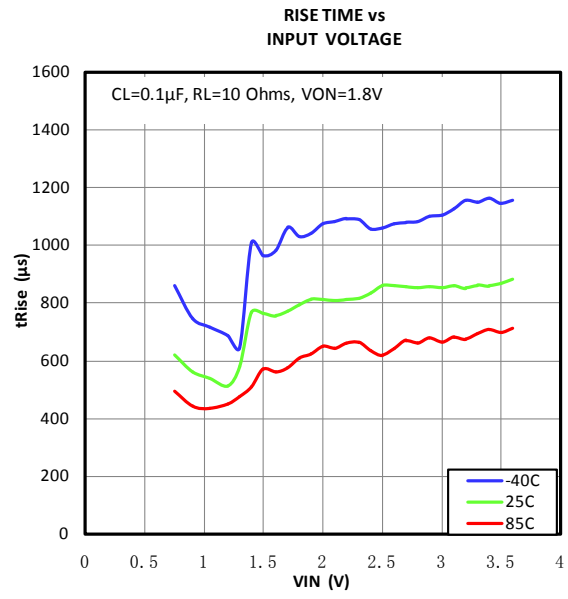
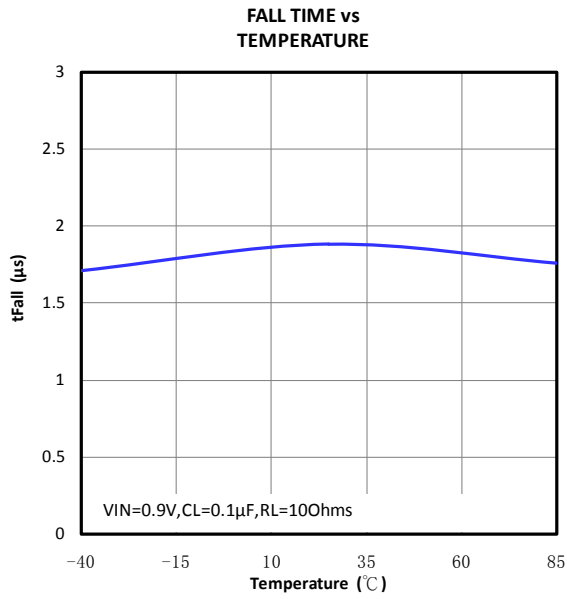

**DISTCONTINUED - NO ALTERNATIVE
PART NUMBERS**



PI3PD22919

Ultra Small, Low-Input Voltage, Low R_{ON} Load Switch

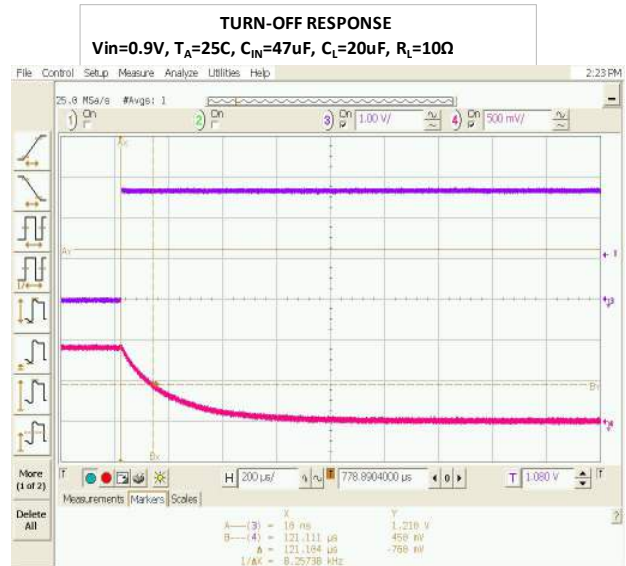
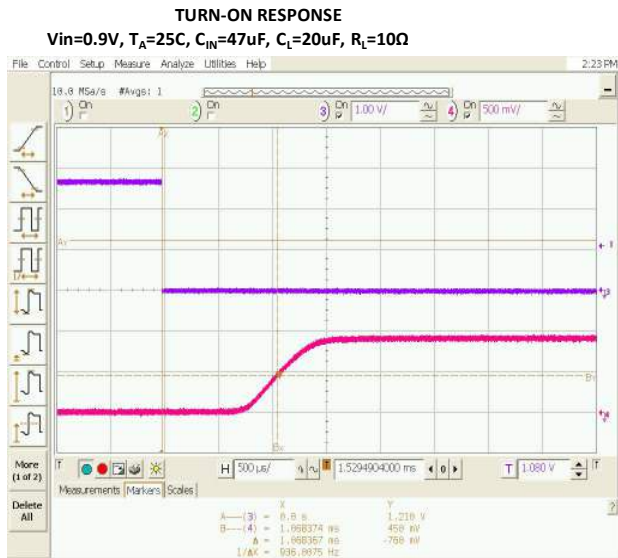
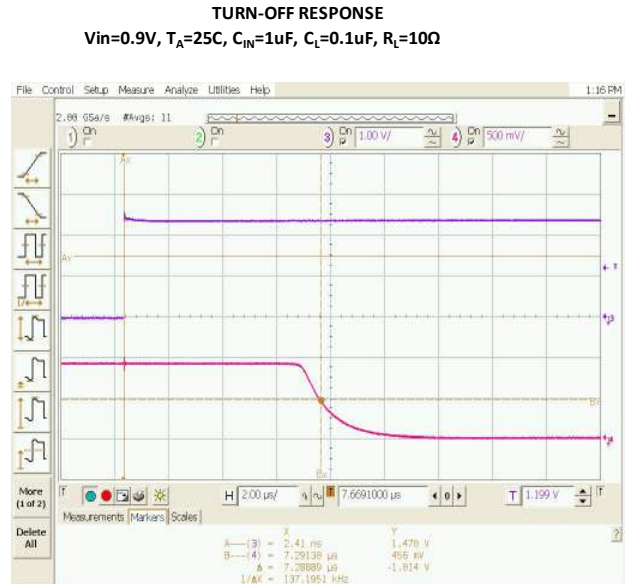
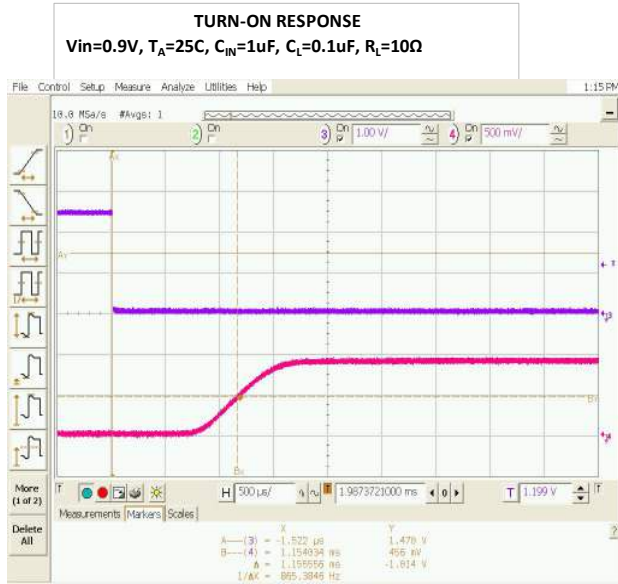

TURN-ON RESPONSE

Vin=3.6V, TA=25C, CIN=1uF, CL=0.1uF, RL=10Ω

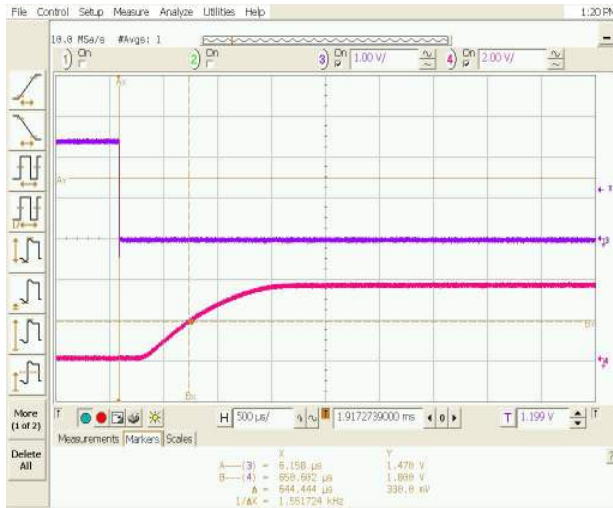

TURN-OFF RESPONSE

Vin=3.6V, TA=25C, CIN=1uF, CL=0.1uF, RL=10Ω

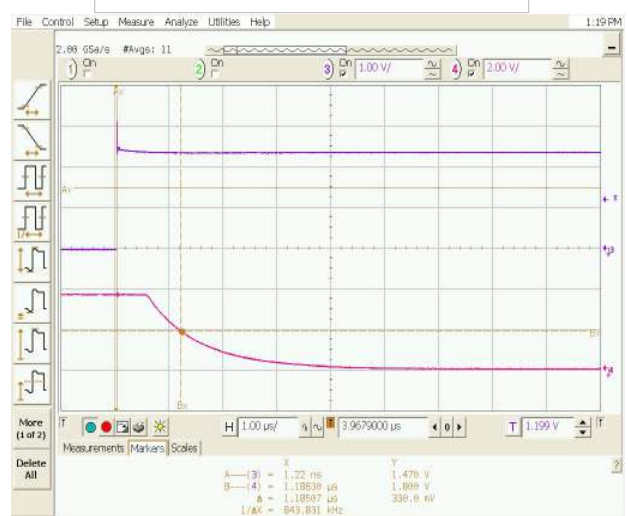

TURN-ON RESPONSE

Vin=3.6V, TA=25C, CIN=47uF, CL=20uF, RL=10Ω

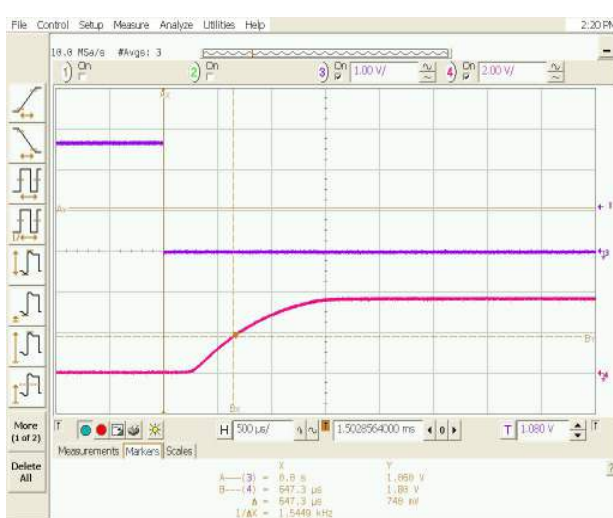

TURN-OFF RESPONSE

Vin=3.6V, TA=25C, CIN=47uF, CL=20uF, RL=10Ω

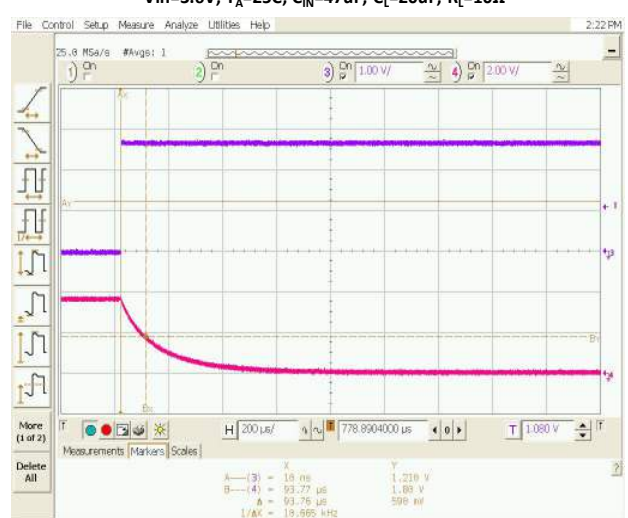

Packaging Mechanicals: 8-contact CSP (GB)

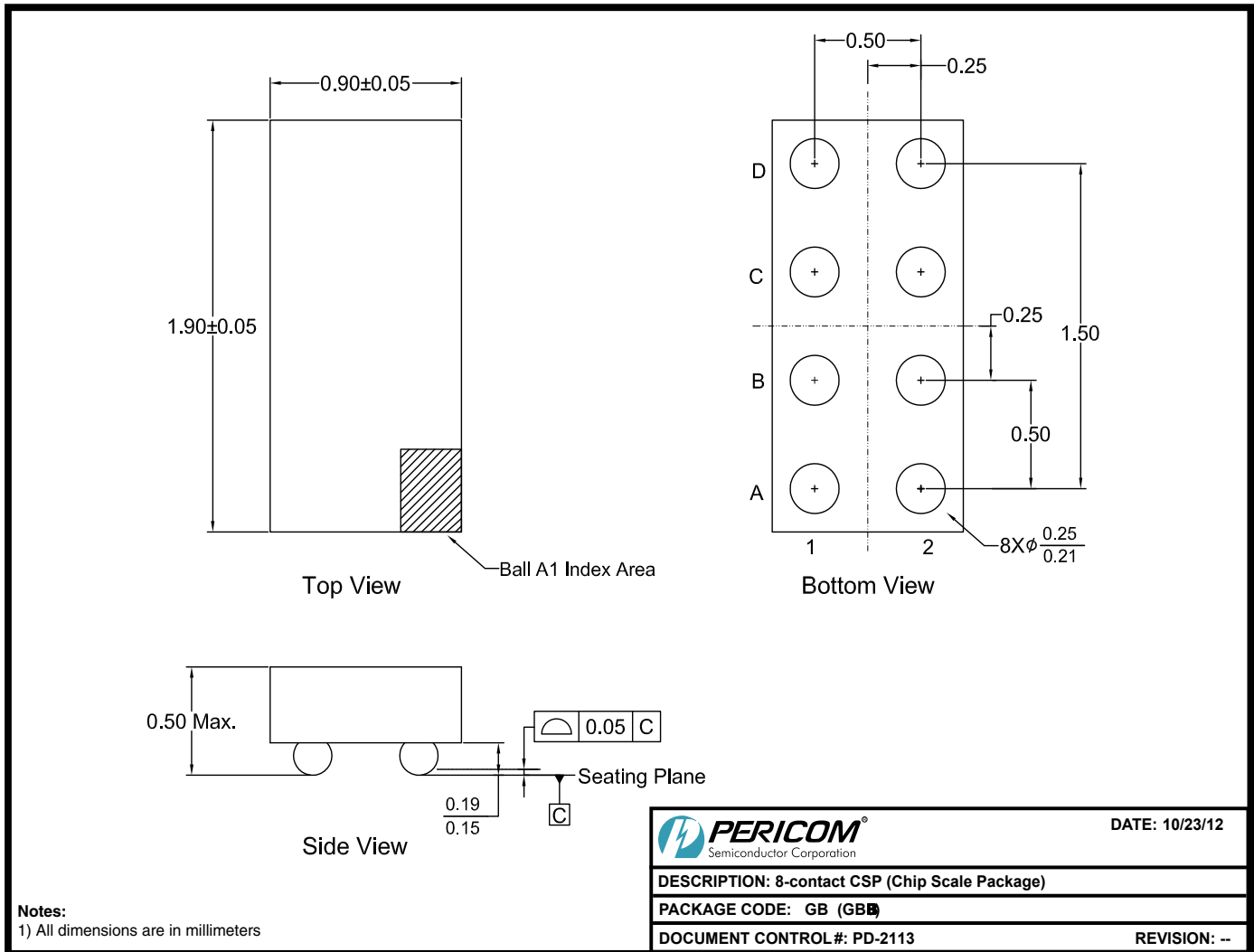

Ordering Information⁽¹⁻³⁾

Ordering Code	Package Code	Package Description
PI3PD22919GBE	GB	8-contact Chip Scale Package (CSP), Pb-free & Green

Notes:

1. Thermal characteristics can be found on the company web site at www.pericom.com/packaging/
2. E = Pb-free and Green
3. Adding an X suffix = Tape/Reel