

bq2510x 250-mA Single Cell Li-Ion Battery Chargers, 1-mA Termination, 75-nA Battery Leakage

1 Features

- Charging
 - 1% Charge Voltage Accuracy
 - 10% Charge Current Accuracy
 - Supports Applications for Very Low Charge Currents - 10 mA to 250 mA
 - Supports minimum 1-mA Charge Termination Current
 - Ultra Low Battery Output Leakage Current - Maximum 75 nA
 - Adjustable Termination and Precharge Threshold
 - High voltage Chemistry Support: 4.35 V with bq25100H/01H, 4.30 V with bq25100A
- Protection
 - 30-V Input Rating; with 6.5-V Input Overvoltage Protection
 - Input Voltage Dynamic Power Management
 - 125°C Thermal Regulation; 150°C Thermal Shutdown Protection
 - OUT Short-Circuit Protection and ISET Short Detection
 - Operation over JEITA Range via Battery NTC – 1/2 Fast-Charge-Current at Cold, 4.06 V (bq25100/01) or 4.2 V (bq25100H/01H) at Hot
 - Fixed 10 Hour Safety Timer
- System
 - Automatic Termination and Timer Disable Mode (TTDM) for Absent Battery Pack
 - Available in Small 1.60 mm × 0.90 mm DSBGA Package

2 Applications

- Fitness Accessories
- Smart Watches
- Bluetooth® Headsets
- Low-Power Handheld Devices

3 Description

The bq2510x series of devices are highly integrated Li-Ion and Li-Pol linear chargers targeted at space-limited portable applications. The high input voltage range with input overvoltage protection supports low-cost unregulated adapters.

The bq2510x has a single power output that charges the battery. A system load can be placed in parallel with the battery as long as the average system load does not keep the battery from charging fully during the 10 hour safety timer.

The battery is charged in three phases: conditioning, constant current and constant voltage. In all charge phases, an internal control loop monitors the IC junction temperature and reduces the charge current if an internal temperature threshold is exceeded.

The charger power stage and charge current sense functions are fully integrated. The charger function has high accuracy current and voltage regulation loops and charge termination. The pre-charge current and termination current threshold are programmed via an external resistor on the bq2510x. The fast charge current value is also programmable via an external resistor.

Device Information⁽¹⁾

PART NUMBER	PACKAGE	BODY SIZE (NOM)
bq25100	DSBGA (6)	1.60 mm × 0.90 mm
bq25101	DSBGA (6)	1.60 mm × 0.90 mm
bq25100A	DSBGA (6)	1.60 mm × 0.90 mm
bq25100H	DSBGA (6)	1.60 mm × 0.90 mm
bq25101H	DSBGA (6)	1.60 mm × 0.90 mm
bq25100L ⁽²⁾	DSBGA (6)	1.60 mm × 0.90 mm

(1) For all available packages, see the orderable addendum at the end of the datasheet.

(2) Product preview. Contact the local TI representative for device details.

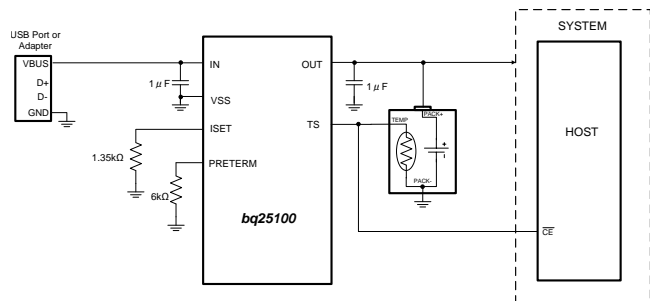

Table of Contents

1 Features	1	9 Application and Implementation	22
2 Applications	1	9.1 Application Information.....	22
3 Description	1	9.2 Typical Application - Charger Application Design Example	22
4 Revision History	2	10 Power Supply Recommendations	24
5 Device Comparison Table	3	10.1 Leakage Current Effects on Battery Capacity.....	24
6 Pin Configuration and Functions	3	11 Layout	24
7 Specifications	4	11.1 Layout Guidelines	24
7.1 Absolute Maximum Ratings	4	11.2 Layout Example	25
7.2 Handling Ratings.....	4	11.3 Thermal Package.....	25
7.3 Recommended Operating Conditions	4	12 Device and Documentation Support	26
7.4 Thermal Information	4	12.1 Device Support	26
7.5 Electrical Characteristics.....	5	12.2 Related Links	26
7.6 Typical Characteristics.....	8	12.3 Trademarks	26
8 Detailed Description	12	12.4 Electrostatic Discharge Caution.....	26
8.1 Overview	12	12.5 Glossary.....	26
8.2 Functional Block Diagram	14	13 Mechanical, Packaging, and Orderable Information	26
8.3 Feature Description.....	15		
8.4 Device Functional Modes.....	18		

4 Revision History

NOTE: Page numbers for previous revisions may differ from page numbers in the current version.

Changes from Revision B (October 2014) to Revision C	Page
• Changed data sheet title	1
• Deleted product preview note from bq25101H in Device Information Table.....	1
• Deleted product preview note from bq25101H in Device Comparison Table	3

Changes from Revision A (September 2014) to Revision B	Page
• Deleted product preview note from bq25101 and bq25100H in Device Information Table.....	1
• Deleted product preview note from bq25101 and bq25100H in Device Comparison Table	3

Changes from Original (August 2014) to Revision A	Page
• Release to Production	1

5 Device Comparison Table

PART NUMBER	V _{O(REG)}	V _{OVP}	PreTerm / $\overline{\text{CHG}}$	TS
bq25100	4.20 V	6.5 V	PreTerm	TS (JEITA)
bq25101	4.20 V	6.5 V	$\overline{\text{CHG}}$	TS (JEITA)
bq25100A	4.30 V	6.5 V	PreTerm	TS
bq25100H	4.35 V	6.5 V	PreTerm	TS (JEITA)
bq25101H	4.35 V	6.5 V	$\overline{\text{CHG}}$	TS (JEITA)
bq25100L ⁽¹⁾	4.06 V	6.5V	PreTerm	TS

(1) Product preview. Contact the local TI representative for device details.

6 Pin Configuration and Functions

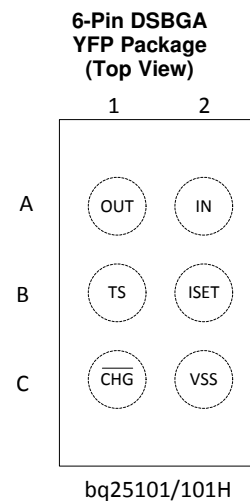
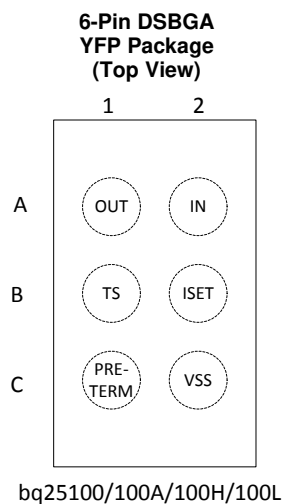

Pin Functions

PIN		I/O	DESCRIPTION
NAME	NUMBER		
$\overline{\text{CHG}}$	C1 ⁽¹⁾		Low (FET on) indicates charging and open drain (FET off) indicates no charging or the first charge cycle complete.
IN	A2	I	Input power, connected to external DC supply (AC adapter or USB port). Expected range of bypass capacitors 1 μF to 10 μF , connect from IN to V _{SS} .
ISET	B2	I	Programs the fast-charge current setting. External resistor from ISET to VSS defines fast charge current value. Recommended range is 13.5 k Ω (10 mA) to 0.54 k Ω (250 mA).
OUT	A1	O	Battery Connection. System Load may be connected. Expected range of bypass capacitors 1 μF to 10 μF .
PRE-TERM	C1 ⁽¹⁾	I	Programs the current termination threshold (1% to 50% of I _{out} , 1mA minimum). The pre-charge current is twice the termination current level. Expected range of programming resistor is 600 Ω to 30 k Ω (6k: I _{chg} /10 for term; I _{chg} /5 for precharge)
TS	B1	I	Temperature sense pin connected to 10k at 25°C NTC thermistor, in the battery pack. Floating TS pin or pulling high puts part in TTDM "Charger" mode and disables TS monitoring, Timers and Termination. Pulling pin low disables the IC. If NTC sensing is not needed, connect this pin to VSS through an external 10-k Ω resistor. A 250-k Ω resistor from TS to ground will prevent IC entering TTDM mode when battery with thermistor is removed.
VSS	C2	–	Ground pin

(1) Spins have different pin definitions

7 Specifications

7.1 Absolute Maximum Ratings⁽¹⁾

over operating free-air temperature range (unless otherwise noted)

		MIN	MAX	UNIT
Input voltage	IN (with respect to VSS)	-0.3	30	V
	OUT (with respect to VSS)	-0.3	7	V
	PRE-TERM, ISET, TS, $\overline{\text{CHG}}$ (with respect to VSS)	-0.3	7	V
Input current	IN		300	mA
Output current (continuous)	OUT		300	mA
Output sink current	$\overline{\text{CHG}}$		15	mA
T _J	Junction temperature	-40	150	°C

- (1) Stresses beyond those listed under absolute maximum ratings may cause permanent damage to the device. These are stress ratings only, and functional operation of the device at these or any other conditions beyond those indicated under recommended operating conditions is not implied. Exposure to absolute-maximum-rated conditions for extended periods may affect device reliability. All voltage values are with respect to the network ground terminal unless otherwise noted.

7.2 Handling Ratings

				MIN	MAX	UNIT
ESD	Electrostatic discharge (IEC61000-4-2) ⁽¹⁾	IN, OUT, TS	1 μF between IN and GND, 1 μF between TS and GND, 2 μF between OUT and GND, x5R Ceramic or equivalent		8 contact 15 Air	kV
T _{STG}	Storage temperature			-65	150	°C

- (1) The test was performed on IC pins that may potentially be exposed to the customer at the product level. The bq2510x IC requires a minimum of the listed capacitance, external to the IC, to pass the ESD test.

7.3 Recommended Operating Conditions⁽¹⁾

		MIN	NOM	UNIT
V _{IN}	IN voltage range	3.5	28	V
	IN operating voltage range, Restricted by V _{DPM} and V _{OVP}	4.45	6.45	V
I _{IN}	Input current, IN pin		250	mA
I _{OUT}	Current, OUT pin		250	mA
T _J	Junction temperature	0	125	°C
R _{PRE-TERM}	Programs precharge and termination current thresholds	0.6	30	k Ω
R _{ISET}	Fast-charge current programming resistor	0.54	13.5	k Ω
R _{TS}	10k NTC thermistor range without entering $\overline{\text{BAT_EN}}$ or TTDM	1.66	258	k Ω

- (1) Operation with V_{IN} less than 4.5V or in drop-out may result in reduced performance.

7.4 Thermal Information

THERMAL METRIC ⁽¹⁾		bq25100	UNIT
		YFP (6 PINS)	
R _{θJA}	Junction-to-ambient thermal resistance	132.9	°C/W
R _{θJctop}	Junction-to-case (top) thermal resistance	1.3	
R _{θJB}	Junction-to-board thermal resistance	21.8	
ψ _{JT}	Junction-to-top characterization parameter	5.6	
ψ _{JB}	Junction-to-board characterization parameter	21.8	
R _{θJcbot}	Junction-to-case (bottom) thermal resistance	n/a	

- (1) For more information about traditional and new thermal metrics, see the *IC Package Thermal Metrics* application report, [SPRA953](#).

7.5 Electrical Characteristics

 Over junction temperature range $0^{\circ}\text{C} \leq T_J \leq 125^{\circ}\text{C}$ and recommended supply voltage (unless otherwise noted)

PARAMETER		TEST CONDITIONS	MIN	TYP	MAX	UNIT
INPUT						
UVLO	Undervoltage lock-out exit	$V_{IN}: 0\text{ V} \rightarrow 4\text{ V}$	3.15	3.3	3.45	V
V_{HYS_UVLO}	Hysteresis on V_{UVLO_RISE} falling	$V_{IN}: 4\text{ V} \rightarrow 0\text{ V};$ $V_{UVLO_FALL} = V_{UVLO_RISE} - V_{HYS_UVLO}$		250		mV
V_{IN_DT}	Input power good detection threshold is $V_{OUT} + V_{IN_DT}$	Input power good if $V_{IN} > V_{OUT} + V_{IN_DT};$ $V_{OUT} = 3.6\text{ V}; V_{IN}: 3.5\text{ V} \rightarrow 4\text{ V}$	15	60	130	mV
V_{HYS_INDT}	Hysteresis on V_{IN_DT} falling	$V_{OUT} = 3.6\text{ V}; V_{IN}: 4\text{ V} \rightarrow 3.5\text{ V}$		31		mV
$t_{DGL(PG_PWR)}$	Deglintch time on exiting sleep	Time measured from $V_{IN}: 0\text{ V} \rightarrow 5\text{ V}$ 1- μs rise-time to charge enables; $V_{OUT} = 3.6\text{ V}$		29		ms
$t_{DGL(PG_NO_PWR)}$	Deglintch time on V_{HYS_INDT} power down. Same as entering sleep.	Time measured from $V_{IN}: 5\text{ V} \rightarrow 3.2\text{ V}$ 1- μs fall-time to charge disables; $V_{OUT} = 3.6\text{ V}$		29		ms
V_{OVP}	Input over-voltage protection threshold	$V_{IN}: 5\text{ V} \rightarrow 12\text{ V}$	6.52	6.67	6.82	V
$t_{DGL(OVP_SET)}$	Input over-voltage blanking time	$V_{IN}: 5\text{ V} \rightarrow 12\text{ V}$		113		μs
V_{HYS_OVP}	Hysteresis on OVP	$V_{IN}: 11\text{ V} \rightarrow 5\text{ V}$		110		mV
$t_{DGL(OVP_REC)}$	Deglintch time exiting OVP	Time measured from $V_{IN}: 12\text{ V} \rightarrow 5\text{ V}$ 1- μs fall-time to charge enables		450		μs
V_{IN_DPM}	Low input voltage protection. Restricts Iout at V_{IN_DPM}	Limit input source current to 50 mA; $V_{OUT} = 3.5\text{ V}; R_{ISET} = 1.35\text{ k}\Omega$	4.25	4.31	4.37	V
ISET SHORT CIRCUIT TEST						
R_{ISET_SHORT}	Highest resistor value considered a fault (short).	$R_{ISET}: 540\ \Omega \rightarrow 250\ \Omega$, Iout latches off; Cycle power to reset		420	450	Ω
t_{DGL_SHORT}	Deglintch time transition from ISET short to Iout disable	Clear fault by disconnecting IN or cycling (high / low) TS/BAT_EN		1		ms
I_{OUT_CL}	Maximum OUT current limit regulation (Clamp)	$V_{IN} = 5\text{ V}; V_{OUT} = 3.6\text{ V}; R_{ISET}: 540\ \Omega \rightarrow 250\ \Omega;$ Iout latches off after t_{DGL_SHORT}	550	600	650	mA
BATTERY SHORT PROTECTION						
$V_{OUT(SC)}$	OUT pin short-circuit detection threshold/ precharge threshold	$V_{OUT}: 3\text{ V} \rightarrow 0.5\text{ V};$ No deglitch	0.75	0.8	0.85	V
$V_{OUT(SC_HYS)}$	OUT pin Short hysteresis	Recovery $\geq V_{OUT(SC)} + V_{OUT(SC_HYS)}$; Rising; No deglitch		77		mV
$I_{OUT(SC)}$	Source current to OUT pin during short-circuit detection		9	11	13	mA
QUIESCENT CURRENT						
$I_{OUT(PDWN)}$	Battery current into OUT pin	$V_{IN} = 0\text{ V}; 0^{\circ}\text{C}$ to 125°C			75	nA
		$V_{IN} = 0\text{ V}; 0^{\circ}\text{C}$ to 85°C			50	
$I_{OUT(DONE)}$	OUT pin current, charging terminated	$V_{IN} = 6\text{ V}; V_{OUT} > V_{OUT(REG)}$			6	μA
$I_{IN(STDBY)}$	Standby current into IN pin	TS = GND; $V_{IN} \leq 6\text{ V}$			125	μA
I_{CC}	Active supply current, IN pin	TS = open, $V_{IN} = 6\text{ V};$ TTDM – no load on OUT pin; $V_{OUT} > V_{OUT(REG)};$ IC enabled		0.75	1	mA
BATTERY CHARGER FAST-CHARGE						
$V_{OUT(REG)}$	Output voltage	$T_J = 0^{\circ}\text{C}$ to $125^{\circ}\text{C}; I_{OUT} = 0\text{ mA}$ to $250\text{ mA};$ $V_{IN} = 5.0\text{ V}; V_{TS-45^{\circ}\text{C}} \leq V_{TS} \leq V_{TS-0^{\circ}\text{C}}$ (bq25100/101)	4.16	4.2	4.23	V
		$T_J = 0^{\circ}\text{C}$ to $125^{\circ}\text{C}; I_{OUT} = 0\text{ mA}$ to $250\text{ mA};$ $V_{IN} = 5.0\text{ V}; V_{TS-45^{\circ}\text{C}} \leq V_{TS} \leq V_{TS-0^{\circ}\text{C}}$ (bq25100A)	4.26	4.3	4.33	
		$T_J = 0^{\circ}\text{C}$ to $125^{\circ}\text{C}; I_{OUT} = 0\text{ mA}$ to $250\text{ mA};$ $V_{IN} = 5.0\text{ V}; V_{TS-45^{\circ}\text{C}} \leq V_{TS} \leq V_{TS-0^{\circ}\text{C}}$ (bq25100H/101H)	4.31	4.35	4.38	
		$T_J = -5^{\circ}\text{C}$ to $55^{\circ}\text{C}; I_{OUT} = 10\text{ mA}$ to $75\text{ mA};$ $V_{IN} = 5.0\text{ V}; V_{TS-45^{\circ}\text{C}} \leq V_{TS} \leq V_{TS-0^{\circ}\text{C}}$ (bq25100A)	4.275	4.3	4.325	
$V_{O_HT(REG)}$	Battery hot regulation voltage	$V_{IN} = 5.0\text{ V}; I_{OUT} = 10\text{ mA}$ to $250\text{ mA};$ $V_{TS-60^{\circ}\text{C}} \leq V_{TS} \leq V_{TS-45^{\circ}\text{C}}$ (bq25100/101)	4.02	4.06	4.1	V
		$V_{IN} = 5.0\text{ V}; I_{OUT} = 10\text{ mA}$ to $250\text{ mA};$ $V_{TS-60^{\circ}\text{C}} \leq V_{TS} \leq V_{TS-45^{\circ}\text{C}}$ (bq25100H/101H)	4.16	4.2	4.24	
$I_{OUT(RANGE)}$	Programmed output "fast charge" current range	$V_{OUT(REG)} > V_{OUT} > V_{LOWV}; V_{IN} = 5\text{ V};$ $R_{ISET} = 0.54\text{ k}\Omega$ to $13.5\text{ k}\Omega$	10		250	mA

Electrical Characteristics (continued)

 Over junction temperature range $0^{\circ}\text{C} \leq T_J \leq 125^{\circ}\text{C}$ and recommended supply voltage (unless otherwise noted)

PARAMETER		TEST CONDITIONS	MIN	TYP	MAX	UNIT
$V_{\text{DO(IN-OUT)}}$	Drop-Out, $V_{\text{IN}} - V_{\text{OUT}}$	Adjust V_{IN} down until $I_{\text{OUT}} = 0.2 \text{ A}$; $V_{\text{OUT}} = 4.15 \text{ V}$; $R_{\text{ISET}} = 680 \Omega$; $T_J \leq 100^{\circ}\text{C}$		220	400	mV
I_{OUT}	Output "fast charge" formula	$V_{\text{OUT(REG)}} > V_{\text{OUT}} > V_{\text{LOWV}}$; $V_{\text{IN}} = 5 \text{ V}$		$K_{\text{ISET}}/R_{\text{ISET}}$		A
K_{ISET}	Fast charge current factor	$R_{\text{ISET}} = K_{\text{ISET}}/I_{\text{OUT}}$; $20 < I_{\text{OUT}} < 250 \text{ mA}$	129	135	145	A Ω
		$R_{\text{ISET}} = K_{\text{ISET}}/I_{\text{OUT}}$; $5 < I_{\text{OUT}} < 20 \text{ mA}$	125	135	145	
PRECHARGE – SET BY PRETERM PIN						
V_{LOWV}	Pre-charge to fast-charge transition threshold		2.4	2.5	2.6	V
$t_{\text{DGL1(LOWV)}}$	Deglitch time on pre-charge to fast-charge transition			57		μs
$t_{\text{DGL2(LOWV)}}$	Deglitch time on fast-charge to pre-charge transition			32		ms
$I_{\text{PRE-TERM}}$	Refer to the Termination Section					
$\%_{\text{PRECHG}}$	Pre-charge current, default setting	$V_{\text{OUT}} < V_{\text{LOWV}}$; $R_{\text{ISET}} = 2.7 \text{ k}\Omega$; $R_{\text{PRE-TERM}} = \text{High Z}$ or for BQ25101/101H	18	20	22	$\%I_{\text{OUT-CC}}$
	Pre-charge current formula	$R_{\text{PRE-TERM}} = K_{\text{PRE-CHG}} (\Omega/\%) \times \%_{\text{PRE-CHG}} (\%)$		$R_{\text{PRE-TERM}}/K_{\text{PRE-CHG}\%}$		
$K_{\text{PRE-CHG}}$	% Pre-charge Factor	$V_{\text{OUT}} < V_{\text{LOWV}}$; $V_{\text{IN}} = 5 \text{ V}$; $R_{\text{PRE-TERM}} = 6 \text{ k}\Omega$ to $30 \text{ k}\Omega$; $R_{\text{ISET}} = 1.8 \text{ k}\Omega$; $R_{\text{PRE-TERM}} = K_{\text{PRE-CHG}} \times \%I_{\text{PRE-CHG}}$; where $\%I_{\text{PRE-CHG}}$ is 20 to 100%	280	300	320	$\Omega/\%$
		$V_{\text{OUT}} < V_{\text{LOWV}}$; $V_{\text{IN}} = 5 \text{ V}$; $R_{\text{PRE-TERM}} = 3 \text{ k}\Omega$ to $6 \text{ k}\Omega$; $R_{\text{ISET}} = 1.8 \text{ k}\Omega$; $R_{\text{PRE-TERM}} = K_{\text{PRE-CHG}} \times \%I_{\text{PRE-CHG}}$; where $\%I_{\text{PRE-CHG}}$ is 10% to 20%	265	300	340	$\Omega/\%$
TERMINATION – SET BY PRE-TERM PIN						
$\%_{\text{TERM}}$	Termination threshold current, default setting	$V_{\text{OUT}} > V_{\text{RCH}}$; $R_{\text{ISET}} = 2.7 \text{ k}\Omega$; $R_{\text{PRE-TERM}} = \text{High Z}$ or for BQ25101/101H	9	10	11	$\%I_{\text{OUT-CC}}$
	Termination current threshold formula	$R_{\text{PRE-TERM}} = K_{\text{TERM}} (\Omega/\%) \times \%_{\text{TERM}} (\%)$		$R_{\text{PRE-TERM}}/K_{\text{TERM}}$		
K_{TERM}	% Term factor	$V_{\text{OUT}} > V_{\text{RCH}}$; $V_{\text{IN}} = 5 \text{ V}$; $R_{\text{PRE-TERM}} = 6 \text{ k}\Omega$ to $30 \text{ k}\Omega$; $R_{\text{ISET}} = 1.8 \text{ k}\Omega$; $R_{\text{PRE-TERM}} = K_{\text{TERM}} \times \%I_{\text{TERM}}$; where $\%I_{\text{TERM}}$ is 10 to 50%	575	600	640	$\Omega/\%$
		$V_{\text{OUT}} > V_{\text{RCH}}$; $V_{\text{IN}} = 5 \text{ V}$; $R_{\text{PRE-TERM}} = 3 \text{ k}\Omega$ to $6 \text{ k}\Omega$; $R_{\text{ISET}} = 1.8 \text{ k}\Omega$; $R_{\text{PRE-TERM}} = K_{\text{TERM}} \times \%I_{\text{TERM}}$; where $\%I_{\text{TERM}}$ is 5 to 10%	555	620	685	
		$V_{\text{OUT}} > V_{\text{RCH}}$; $V_{\text{IN}} = 5 \text{ V}$; $R_{\text{PRE-TERM}} = 750 \Omega$ to $3 \text{ k}\Omega$; $R_{\text{ISET}} = 1.8 \text{ k}\Omega$; $R_{\text{PRE-TERM}} = K_{\text{TERM}} \times \%I_{\text{TERM}}$; where $\%I_{\text{TERM}}$ is 1.25% to 5%	352	680	1001	
$I_{\text{PRE-TERM}}$	Current for programming the term. and pre-chg with resistor, $I_{\text{Term-Start}}$ is the initial PRE-TERM current	$R_{\text{PRE-TERM}} = 6 \text{ k}\Omega$; $V_{\text{OUT}} = 4.15 \text{ V}$	23	25	27	μA
I_{TERM}	Termination current range	Minimum absolute termination current	1			mA
$\%_{\text{TERM}}$	Termination current formula			$R_{\text{TERM}}/K_{\text{TERM}}$		%
$t_{\text{DGL(TERM)}}$	Deglitch time, termination detected			29		ms
RECHARGE OR REFRESH						
V_{RCH}	Recharge detection threshold – normal temp	$V_{\text{IN}} = 5 \text{ V}$; $V_{\text{TS}} = 0.5 \text{ V}$; $V_{\text{OUT}}: 4.25 \text{ V} \rightarrow V_{\text{RCH}}$ (bq25100); $V_{\text{OUT}}: 4.35 \text{ V} \rightarrow V_{\text{RCH}}$ (bq25100A); $V_{\text{OUT}}: 4.40 \text{ V} \rightarrow V_{\text{RCH}}$ (bq25100H)	$V_{\text{O(REG)}} - 0.125$	$V_{\text{O(REG)}} - 0.095$	$V_{\text{O(REG)}} - 0.075$	V
	Recharge detection threshold – hot temp	$V_{\text{IN}} = 5 \text{ V}$; $V_{\text{TS}} = 0.2 \text{ V}$; $V_{\text{OUT}}: 4.15 \text{ V} \rightarrow V_{\text{RCH}}$ (bq25100); $V_{\text{OUT}}: 4.25 \text{ V} \rightarrow V_{\text{RCH}}$ (bq25100H)	$V_{\text{O-HT(REG)}} - 0.130$	$V_{\text{O-HT(REG)}} - 0.105$	$V_{\text{O-HT(REG)}} - 0.080$	V
$t_{\text{DGL1(RCH)}}$	Deglitch time, recharge threshold detected	$V_{\text{IN}} = 5 \text{ V}$; $V_{\text{TS}} = 0.5 \text{ V}$; $V_{\text{OUT}}: 4.25 \text{ V} \rightarrow 3.5 \text{ V}$ in $1 \mu\text{s}$; $t_{\text{DGL(RCH)}}$ is time to ISET ramp		29		ms

Electrical Characteristics (continued)

 Over junction temperature range $0^{\circ}\text{C} \leq T_J \leq 125^{\circ}\text{C}$ and recommended supply voltage (unless otherwise noted)

PARAMETER	TEST CONDITIONS	MIN	TYP	MAX	UNIT	
$t_{DGL2(RCH)}$	Deglitch time, recharge threshold detected in OUT-Detect Mode $V_{IN} = 5\text{ V}$; $V_{TS} = 0.5\text{ V}$; $V_{OUT} = 3.5\text{ V}$ inserted; $t_{DGL(RCH)}$ is time to ISET ramp		29		ms	
BATTERY DETECT ROUTINE – (NOTE: In Hot mode $V_{O(REG)}$ becomes $V_{O_HT(REG)}$)						
V_{REG-BD}	VO _{UT} reduced regulation during battery detect	bq25100/101/bq25100H/101H; $V_{IN} = 5\text{ V}$; $V_{TS} = 0.5\text{ V}$, Battery absent	$V_{O(REG)}^-$ 0.450	$V_{O(REG)}^-$ 0.400	$V_{O(REG)}^-$ 0.350	V
		bq25100A; $V_{IN} = 5\text{ V}$; $V_{TS} = 0.5\text{ V}$; Battery absent	$V_{O(REG)}^-$ 0.550	$V_{O(REG)}^-$ 0.500	$V_{O(REG)}^-$ 0.450	
$I_{BD-SINK}$	Sink current during V_{REG-BD}	$V_{IN} = 5\text{ V}$; $V_{TS} = 0.5\text{ V}$; Battery absent		2		mA
$t_{DGL(HI/LOW REG)}$	Regulation time at V_{REG} or V_{REG-BD}	$V_{IN} = 5\text{ V}$; $V_{TS} = 0.5\text{ V}$; Battery absent		25		ms
V_{BD-HI}	High battery detection threshold	$V_{IN} = 5\text{ V}$; $V_{TS} = 0.5\text{ V}$; Battery absent	$V_{O(REG)}^-$ 0.150	$V_{O(REG)}^-$ 0.100	$V_{O(REG)}^-$ 0.050	V
V_{BD-LO}	Low battery detection threshold	$V_{IN} = 5\text{ V}$; $V_{TS} = 0.5\text{ V}$; Battery absent	V_{REG-BD} +0.05	V_{REG-BD} +0.1	V_{REG-BD} +0.15	V
BATTERY CHARGING TIMERS AND FAULT TIMERS						
t_{PRECHG}	Pre-charge safety timer value	Restarts when entering pre-charge; Always enabled when in pre-charge.	1700	1940	2250	s
t_{MAXCH}	Charge safety timer value	Clears fault or resets at UVLO, TS disable, OUT Short, exiting LOWV and Refresh	34000	38800	45000	s
BATTERY-PACK NTC MONITOR (see Note 1); TS pin: 10k NTC						
$I_{NTC-10k}$	NTC bias current	$V_{TS} = 0.3\text{ V}$	48.5	50.5	52.5	μA
$I_{NTC-DIS-10k}$	10k NTC bias current when charging is disabled	$V_{TS} = 0\text{ V}$	27	30	33	μA
$I_{NTC-FLDBK-10k}$	INTC is reduced prior to entering TTDM to keep cold thermistor from entering TTDM	V_{TS} : Set to 1.525 V	4	5	6.5	μA
$V_{TTDM(TS)}$	Termination and timer disable mode Threshold – Enter	V_{TS} : 0.5 V → 1.7 V; Timer held in reset	1550	1600	1650	mV
$V_{HYS-TTDM(TS)}$	Hysteresis exiting TTDM	V_{TS} : 1.7 V → 0.5 V; Timer enabled		100		mV
$V_{CLAMP(TS)}$	TS maximum voltage clamp	$V_{TS} = \text{Open (float)}$	1900	1950	2000	mV
$t_{DGL(TTDM)}$	Deglitch exit TTDM between states			57		ms
	Deglitch enter TTDM between states			8		μs
$V_{TS_I-FLDBK}$	TS voltage where INTC is reduce to keep thermistor from entering TTDM	INTC adjustment (90 to 10%; 45 to 6.6 μA) takes place near this spec threshold; V_{TS} : 1.425 V → 1.525 V		1475		mV
C_{TS}	Optional capacitance – ESD			0.22		μF
$V_{TS-0^{\circ}\text{C}}$	Low temperature CHG pending	Low temp charging to pending; V_{TS} : 1 V → 1.5 V	1230	1255	1280	mV
$V_{HYS-0^{\circ}\text{C}}$	Hysteresis	At 0°C; Charge pending to low temp charging; V_{TS} : 1.5 V → 1 V		100		mV
$V_{TS-10^{\circ}\text{C}}$	Low temperature, half charge	Normal charging to low temp charging; V_{TS} : 0.5 V → 1 V	775	800	830	mV
$V_{HYS-10^{\circ}\text{C}}$	Hysteresis	At 10°C; Low temp charging to normal CHG; V_{TS} : 1 V → 0.5 V		55		mV
$V_{TS-45^{\circ}\text{C}}$	High temperature	At 4.1V (bq25100/101) or 4.2V (bq25100H/101H); Normal charging to high temp CHG; V_{TS} : 0.5 V → 0.2 V	253	268	283	mV
$V_{HYS-45^{\circ}\text{C}}$	Hysteresis	At 45°C; High temp charging to normal CHG; V_{TS} : 0.2 V → 0.5 V		20		mV
$V_{TS-60^{\circ}\text{C}}$	High temperature disable	bq25100/01/100H/101H/100L; High temp charge to pending; V_{TS} : 0.2 V → 0.1 V	160	170	180	mV
$V_{HYS-60^{\circ}\text{C}}$	Hysteresis	At 60°C (bq25100/01/100H/101H/100L); Charge pending to high temp CHG; V_{TS} : 0.1 V → 0.2 V		20		mV

Electrical Characteristics (continued)

Over junction temperature range $0^{\circ}\text{C} \leq T_J \leq 125^{\circ}\text{C}$ and recommended supply voltage (unless otherwise noted)

PARAMETER	TEST CONDITIONS	MIN	TYP	MAX	UNIT		
$t_{DGL(TS_10C)}$	Deglitch for TS thresholds: 10C	Normal to cold operation; $V_{TS}: 0.6\text{ V} \rightarrow 1\text{ V}$		50	ms		
		Cold to normal operation; $V_{TS}: 1\text{ V} \rightarrow 0.6\text{ V}$		12			
$t_{DGL(TS)}$	Deglitch for TS thresholds: 0/45/60C	Battery charging		30	ms		
$V_{TS-EN-10k}$	Charge enable threshold, (10k NTC)	$V_{TS}: 0\text{ V} \rightarrow 0.175\text{ V}$		84	92	100	mV
$V_{TS-DIS_HYS-10k}$	HYS below $V_{TS-EN-10k}$ to disable, (10k NTC)	$V_{TS}: 0.125\text{ V} \rightarrow 0\text{ V}$		12		mV	
THERMAL REGULATION							
$T_{J(REG)}$	Temperature regulation limit			125	$^{\circ}\text{C}$		
$T_{J(OFF)}$	Thermal shutdown temperature			155	$^{\circ}\text{C}$		
$T_{J(OFF-HYS)}$	Thermal shutdown hysteresis			20	$^{\circ}\text{C}$		
LOGIC LEVELS ON /CHG							
V_{OL}	Output low voltage	$I_{SINK} = 5\text{ mA}$		0.4		V	
I_{LEAK}	Leakage current into IC	$V_{CHG} = 5\text{ V}$		1		μA	

7.6 Typical Characteristics

Setup: Typical Applications Schematic; $V_{IN} = 5\text{ V}$, $V_{BAT} = 3.6\text{ V}$ (unless otherwise noted)

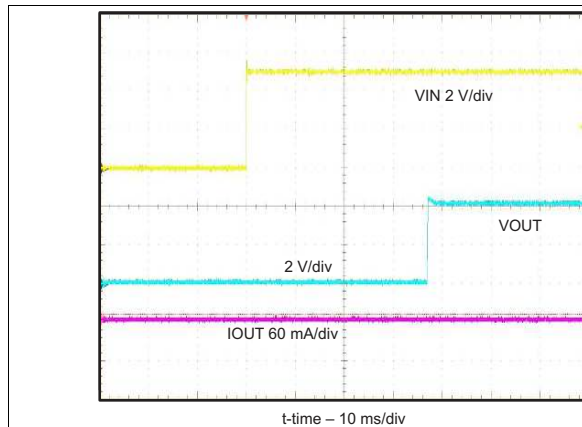

No Battery, No Load

Figure 3. Power Up Timing

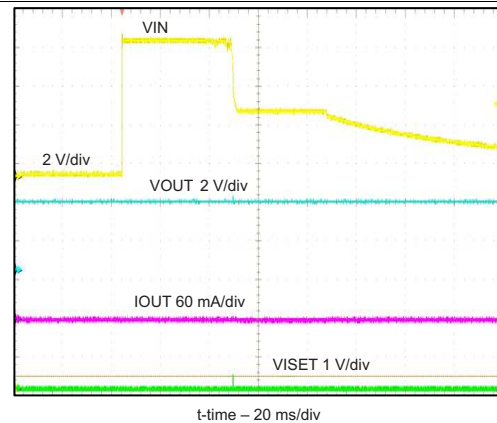

Hot Plug

Figure 4. OVP 7-V Adaptor

Typical Characteristics (continued)

Setup: Typical Applications Schematic; $V_{IN} = 5\text{ V}$, $V_{BAT} = 3.6\text{ V}$ (unless otherwise noted)

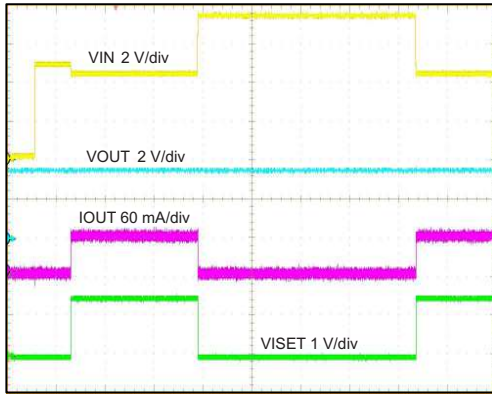

V_{IN} 0 V -5 V-7 V-5 V

t-time – 50 ms/div

Figure 5. OVP from Normal Power-Up Operation

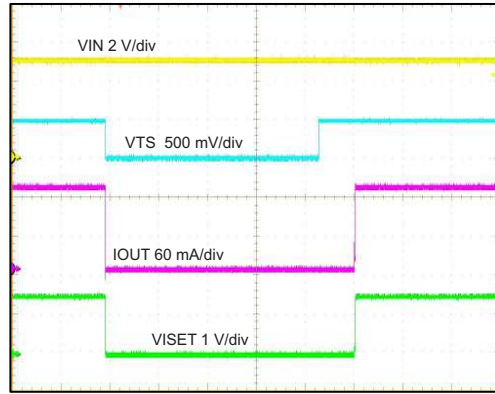

t-time – 50 ms/div

Figure 6. TS Enable and Disable

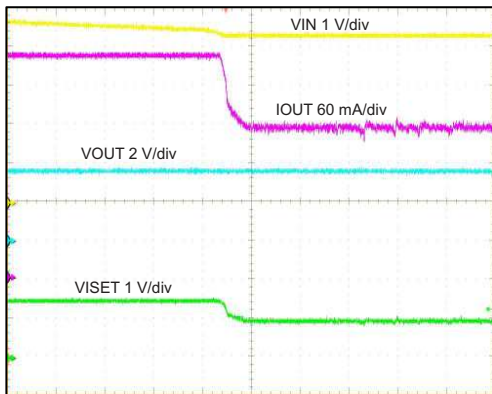

V_{IN} Regulated

t-time – 5 ms/div

Figure 7. DPM-Adaptor Current Limits

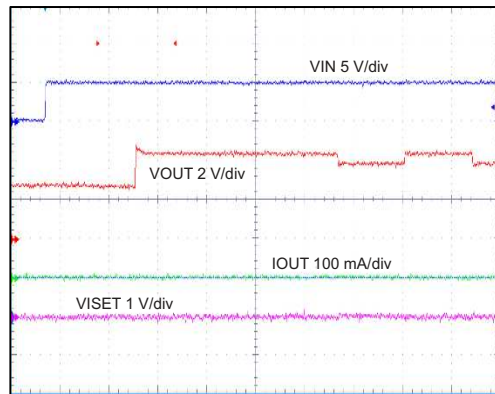

t-time – 20 ms/div

Figure 8. Hot Plug Source with No Battery - Battery Detection

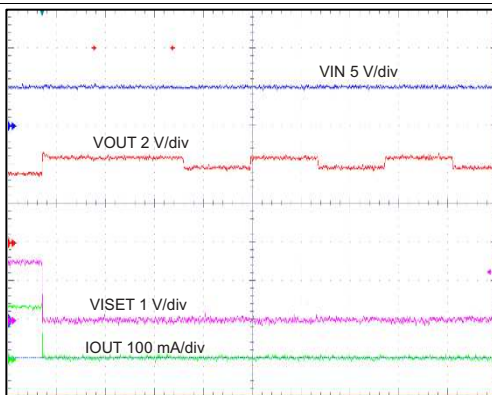

No Load

t-time – 20 ms/div

Figure 9. Battery Removal

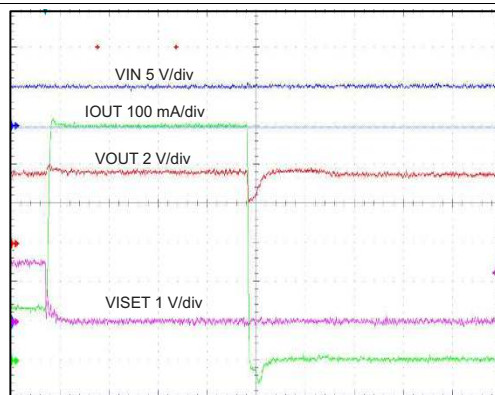

t-time – 200 μ s/div

Figure 10. ISET Shorted During Normal Operation

Typical Characteristics (continued)

Setup: Typical Applications Schematic; $V_{IN} = 5\text{ V}$, $V_{BAT} = 3.6\text{ V}$ (unless otherwise noted)

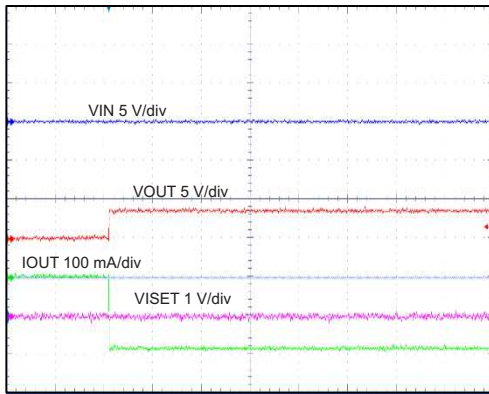

t-time – 10 ms/div

20-Ω resistor at OUT, No input, $V_{BAT} = 3.7\text{ V}$

Figure 11. Battery Plug In

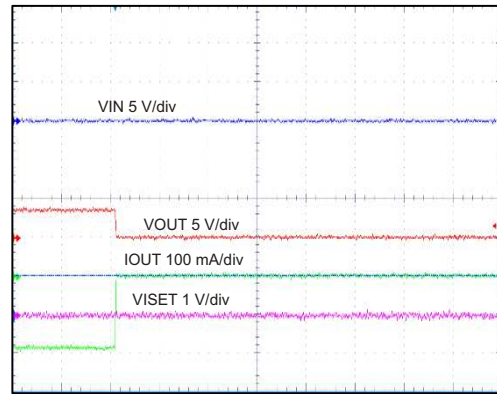

t-time – 10 ms/div

20-Ω resistor at OUT, No input, $V_{BAT} = 3.7\text{ V}$

Figure 12. Battery Removal

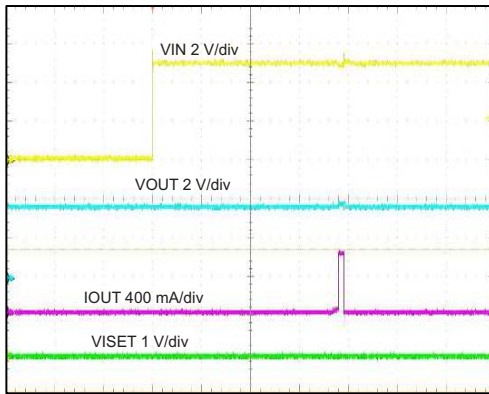

t-time – 10 ms/div

Figure 13. ISET Short Prior to Power Up

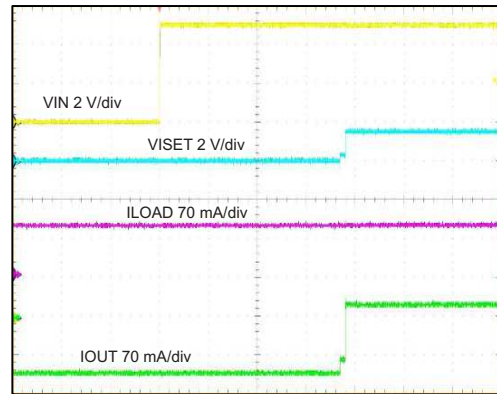

t-time – 10 ms/div

90-mA Load, 120-mA ICHG

Figure 14. Power Up

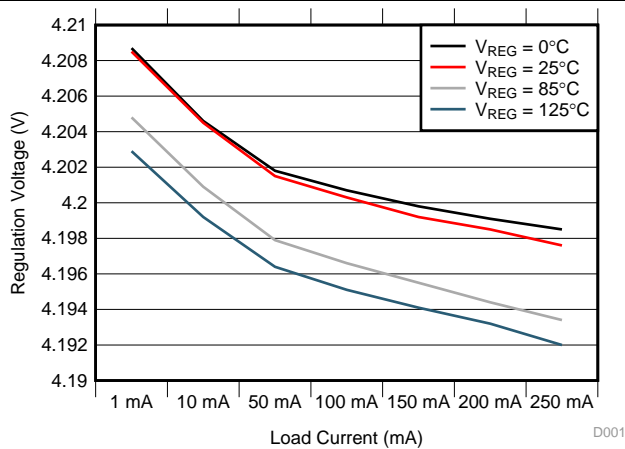

Figure 15. Load Regulation Over Temperature

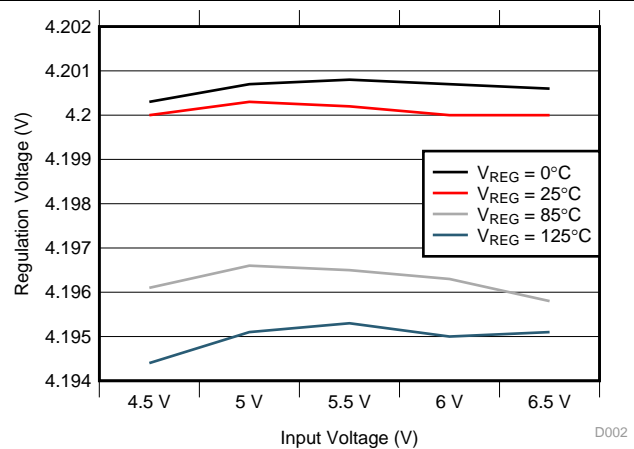
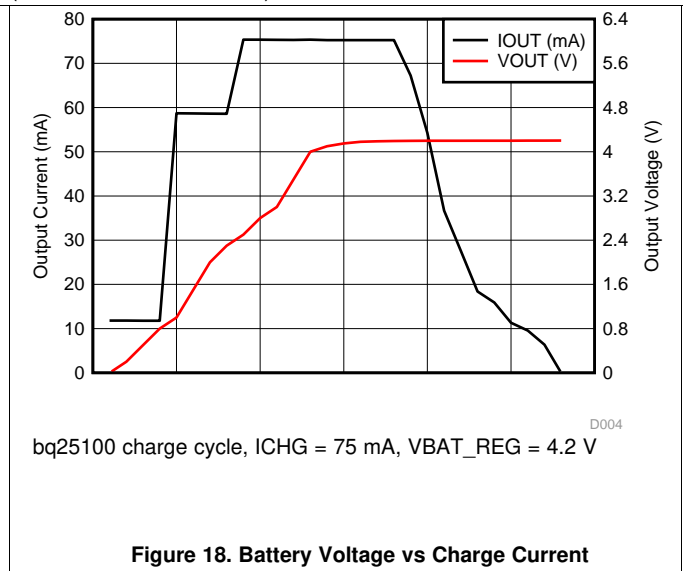
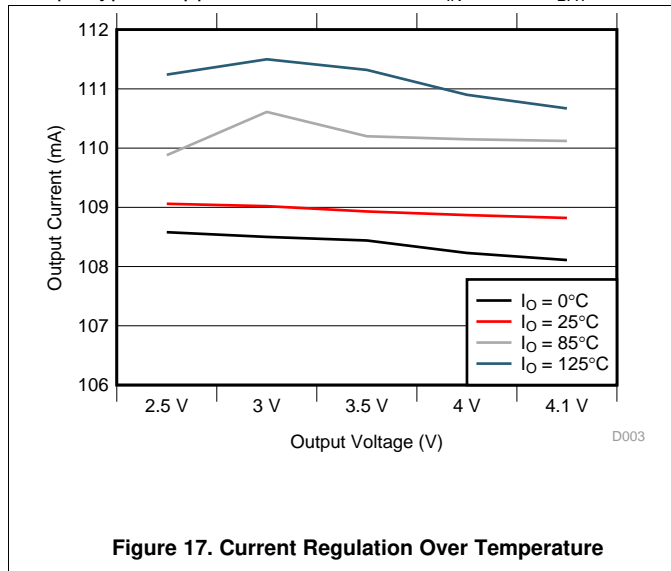

Figure 16. Line Regulation Over Temperature

Typical Characteristics (continued)

Setup: Typical Applications Schematic; $V_{IN} = 5\text{ V}$, $V_{BAT} = 3.6\text{ V}$ (unless otherwise noted)



8 Detailed Description

8.1 Overview

The bq2510x is a highly integrated family of single cell Li-Ion and Li-Pol chargers. The charger can be used to charge a battery, power a system or both. The charger has three phases of charging: pre-charge to recover a fully discharged battery, fast-charge constant current to supply the charge safely and voltage regulation to safely reach full capacity. The charger is very flexible, allowing programming of the fast-charge current and Pre-charge/Termination Current. This charger is designed to work with a USB connection (100-mA limit) or Adaptor (DC output). The charger also checks to see if a battery is present.

The charger also comes with a full set of safety features: JEITA Temperature Standard (bq25100/01/100H/101H), Over-Voltage Protection, DPM-IN, Safety Timers, and ISET short protection. All of these features and more are described in detail below.

The charger is designed for a single power path from the input to the output to charge a single cell Li-Ion or Li-Pol battery pack. Upon application of a 5-V DC power source the ISET and OUT short checks are performed to assure a proper charge cycle.

If the battery voltage is below the LOWV threshold, the battery is considered discharged and a preconditioning cycle begins. The amount of precharge current can be programmed using the PRE-TERM pin which programs a percent of fast charge current (10 to 100%) as the precharge current. This feature is useful when the system load is connected across the battery “stealing” the battery current. The precharge current can be set higher to account for the system loading while allowing the battery to be properly conditioned. The PRE-TERM pin is a dual function pin which sets the precharge current level and the termination threshold level. The termination “current threshold” is always half of the precharge programmed current level.

Once the battery voltage has charged to the VLOWV threshold, fast charge is initiated and the fast charge current is applied. The fast charge constant current is programmed using the ISET pin. The constant current provides the bulk of the charge. Power dissipation in the IC is greatest in fast charge with a lower battery voltage. If the IC reaches 125°C, the IC enters thermal regulation, slows the timer clock by half, and reduces the charge current as needed to keep the temperature from rising any further. [Figure 19](#) shows the charging profile with thermal regulation. Typically under normal operating conditions, the IC’s junction temperature is less than 125°C and thermal regulation is not entered.

Once the cell has charged to the regulation voltage the voltage loop takes control and holds the battery at the regulation voltage until the current tapers to the termination threshold. The termination can be disabled if desired.

Further details are described in the Operating Modes section.

Overview (continued)

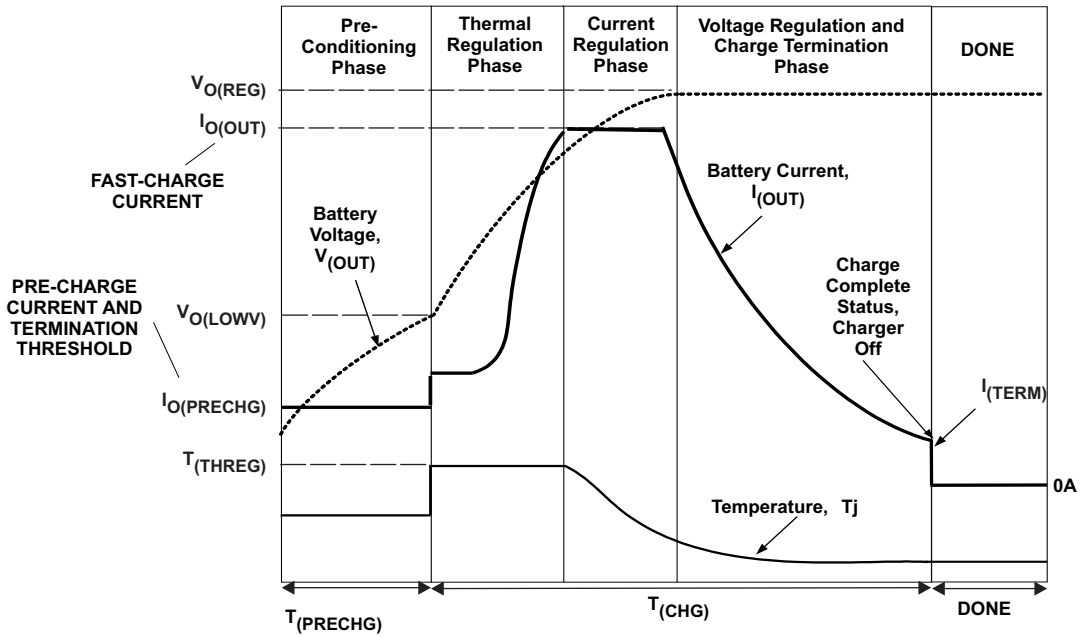
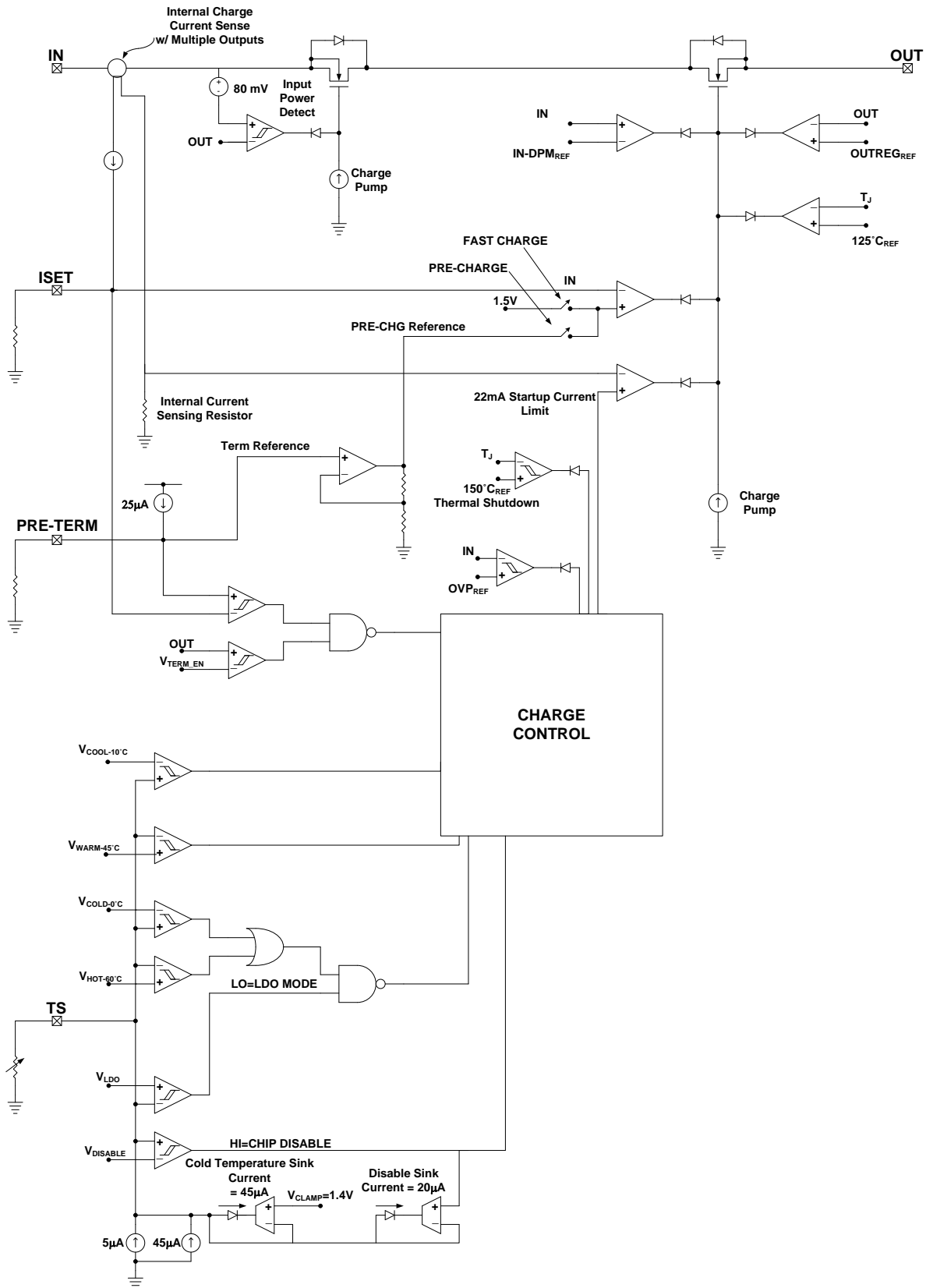

Figure 19. Charging Profile With Thermal Regulation

8.2 Functional Block Diagram



8.3 Feature Description

8.3.1 Overvoltage-Protection (OVP) – Continuously Monitored

If the input source applies an overvoltage, the pass FET, if previously on, turns off after a deglitch, $t_{BLK(OVP)}$. The timer stops counting. Once the overvoltage returns to a normal voltage, the timer and charge continues.

8.3.2 \overline{CHG} Pin Indication (bq25101, bq25101H)

The charge pin has an internal open drain FET which is on (pulls down to VSS) during the first charge only (independent of TTDM) and is turned off once the battery reaches voltage regulation and the charge current tapers to the termination threshold set by the PRE-TERM resistor. The bq25101/01H terminates at 10% of the programmed charge current. The charge pin is high impedance in sleep mode and OVP and returns to its previous state once the condition is removed. Cycling input power, removing and replacing the battery, pulling the TS pin low and releasing or entering pre-charge mode causes the \overline{CHG} pin to go reset (go low if power is good and a discharged battery is attached) and is considered the start of a first charge.

8.3.3 \overline{CHG} Pin LED Pull-up Source (bq25101, bq25101H)

For host monitoring, a pull-up resistor is used between the \overline{CHG} pin and the VCC of the host and for a visual indication a resistor in series with an LED is connected between the /CHG pin and a power source. If the CHG source is capable of exceeding 7 V, a 6.2-V zener should be used to clamp the voltage. If the source is the OUT pin, note that as the battery changes voltage, and the brightness of the LEDs vary.

8.3.4 IN-DPM (V_{IN-DPM} or IN-DPM)

The IN-DPM feature is used to detect an input source voltage that is folding back (voltage dropping), reaching its current limit due to excessive load. When the input voltage drops to the V_{IN-DPM} threshold the internal pass FET starts to reduce the current until there is no further drop in voltage at the input. This would prevent a source with voltage less than V_{IN-DPM} to power the out pin. This is an added safety feature that helps protect the source from excessive loads. This feature is not applicable for bq25100A.

8.3.5 OUT

The Charger's OUT pin provides current to the battery and to the system, if present. This IC can be used to charge the battery plus power the system, charge just the battery or just power the system (TTDM) assuming the loads do not exceed the available current. The OUT pin is a current limited source and is inherently protected against shorts. If the system load ever exceeds the output programmed current threshold, the output will be discharged unless there is sufficient capacitance or a charged battery present to supplement the excessive load.

8.3.6 ISET

An external resistor is used to Program the Output Current (10 to 250 mA) and can be used as a current monitor.

$$R_{ISET} = K_{ISET} \div I_{OUT} \quad (1)$$

Where:

- I_{OUT} is the desired fast charge current;
- K_{ISET} is a gain factor found in the electrical specification

For greater accuracy at lower currents, part of the sense FET is disabled to give better resolution. Going from higher currents to low currents, there is hysteresis and the transition occurs around 50 mA.

The ISET resistor is short protected and will detect a resistance lower than $\approx 420 \Omega$. The detection requires at least 50 mA of output current. If a "short" is detected, then the IC will latch off and can be reset by cycling the power or cycling TS pin. The OUT current is internally clamped to a maximum current of 600 mA typical and is independent of the ISET short detection circuitry.

For charge current that is below 50 mA, an extra RC circuit is recommended on ISET to achieve more stable current signal. More detail is available in 9.1 Application Information.

Feature Description (continued)

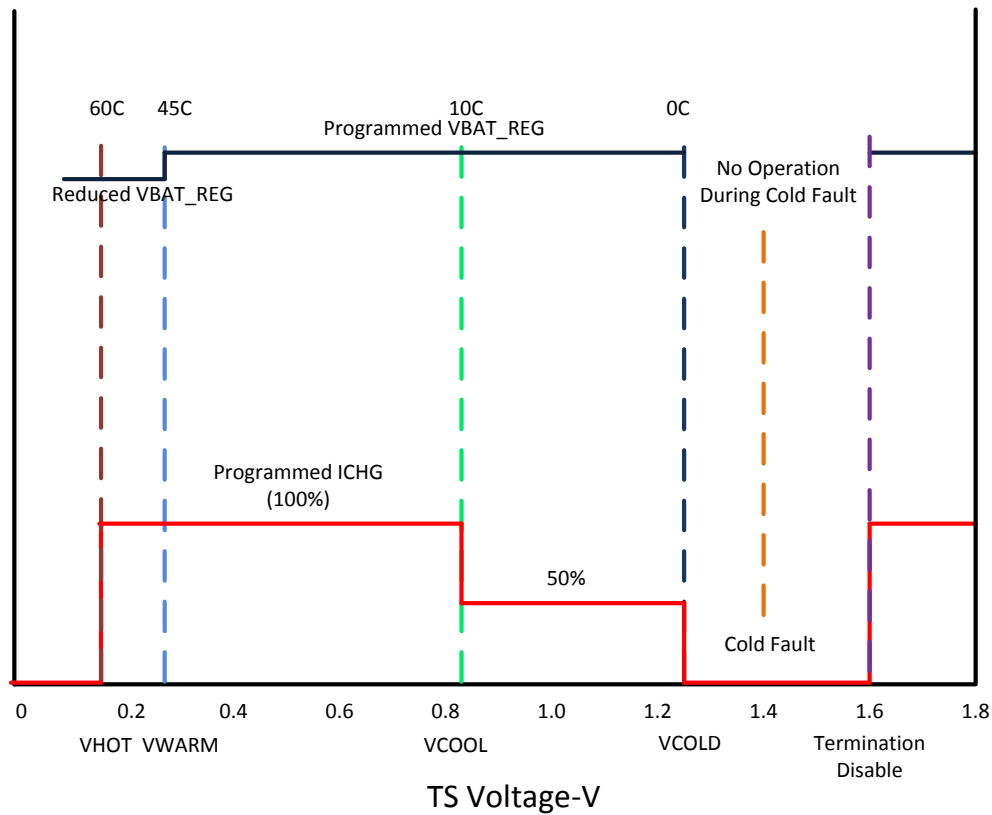

Figure 20. Operation Over TS Bias Voltage - bq25100, bq25100H, bq25101, bq25101H

Feature Description (continued)

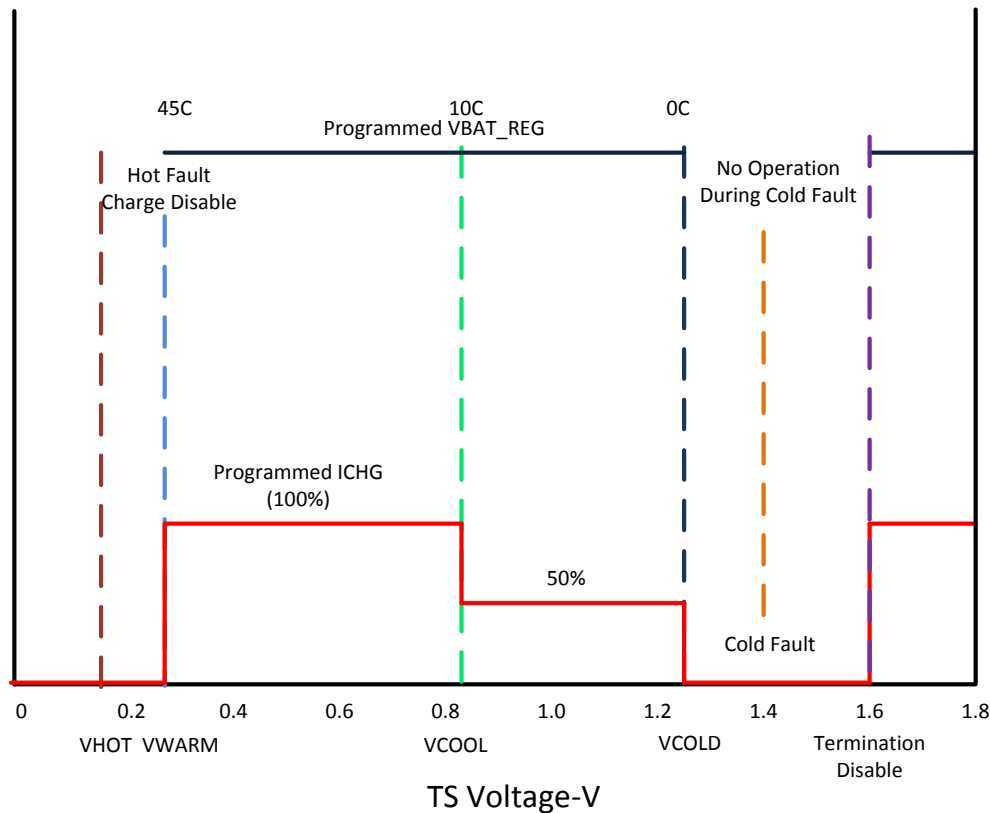

Figure 21. Operation Over TS Bias Voltage – bq25100A

8.3.7 PRE_TERM – Pre-Charge and Termination Programmable Threshold

Pre-Term is used to program both the pre-charge current and the termination current threshold. The pre-charge current level is a factor of two higher than the termination current level. The termination can be set between 5 and 50% (recommended range) of the programmed output current level set by ISET. If left floating the termination and pre-charge are set internally at 10/20% respectively. The R_{PRE-TERM} is ranged from 600 Ω to 30 kΩ and the minimum termination current can be programmed to 1 mA. The pre-charge-to-fast-charge, V_{lowv} threshold is set to 2.5 V.

$$R_{PRE-TERM} = \%Term \times K_{TERM} = \%Pre-CHG \times K_{PRE-CHG} \tag{2}$$

Where:

- %Term is the percent of fast charge current where termination occurs;
- %Pre-CHG is the percent of fast charge current that is desired during precharge;
- K_{TERM} and K_{PRE-CHG} are gain factors found in the electrical specifications.

8.3.8 TS

The TS function for the bq2510x family is designed to follow the new JEITA temperature standard (bq25100/bq25100H/bq25101/bq25101H) for Li-Ion and Li-Pol batteries. There are now four thresholds, 60°C, 45°C, 10°C, and 0°C. Normal operation occurs between 10°C and 45°C. If between 0°C and 10°C the charge current level is cut in half and if between 45°C and 60°C the regulation voltage is reduced to 4.1 V max for bq25100 and 4.2 V max for bq25100H, see Figure 20. The TS function for the bq25100A cut the charge current level in half between 0°C and 10°C and disables charging when the NTC temperature is above 45°C.

Feature Description (continued)

The TS feature is implemented using an internal 50 μ A current source to bias the thermistor (designed for use with a 10-k NTC $\beta = 3370$ (SEMITEC 103AT-2 or Mitsubishi TH05-3H103F) connected from the TS pin to V_{SS} . If this feature is not needed, a fixed 10-k can be placed between TS and V_{SS} to allow normal operation. This may be done if the host is monitoring the thermistor and then the host would determine when to pull the TS pin low to disable charge.

The TS pin has two additional features, when the TS pin is pulled low or floated/driven high. A low disables charge and a high puts the charger in TTDM.

Above 60°C (45°C for bq25100A) or below 0°C the charge is disabled. Once the thermistor reaches $\pm 10^\circ\text{C}$ the TS current folds back to keep a cold thermistor (between -10°C and -50°C) from placing the IC in the TTDM mode. If the TS pin is pulled low into disable mode, the current is reduced to $\approx 30 \mu\text{A}$. Since the I_{TS} current is fixed along with the temperature thresholds, it is not possible to use thermistor values other than the 10-k NTC (at 25°C).

8.3.9 Timers

The pre-charge timer is set to 30 minutes. The pre-charge current, can be programmed to off-set any system load, making sure that the 30 minutes is adequate.

The fast charge timer is fixed at 10 hours and can be increased real time by going into thermal regulation or IN-DPM. The timer clock slows by a factor of 2, resulting in a clock that counts half as fast when in these modes. If either the 30 minute or ten hour timer times out, the charging is terminated and for bq25101/1H the $\overline{\text{CHG}}$ pin goes high impedance if not already in that state. The timer is reset by disabling the IC, cycling power or going into and out of TTDM.

8.3.10 Termination

Once the OUT pin goes above VRCH, (reaches voltage regulation) and the current tapers down to the termination threshold, a battery detect routine is run to determine if the battery was removed or the battery is full. If the battery is present, the charge current will terminate. If the battery was removed along with the thermistor, then the TS pin is driven high and the charge enters TTDM. If the battery was removed and the TS pin is held in the active region, then the battery detect routine will continue until a battery is inserted. The termination current can be programmed down to 625 μA , however, the accuracy will reduce accordingly when the termination current is below 1 mA.

8.4 Device Functional Modes

8.4.1 Power-Down or Undervoltage Lockout (UVLO)

The bq2510x family is in power down mode if the IN pin voltage is less than UVLO. The part is considered “dead” and all the pins are high impedance. Once the IN voltage rises above the UVLO threshold the IC will enter Sleep Mode or Active mode depending on the OUT pin (battery) voltage.

8.4.2 Power-up

The IC is alive after the IN voltage ramps above UVLO (see sleep mode), resets all logic and timers, and starts to perform many of the continuous monitoring routines. Typically the input voltage quickly rises through the UVLO and sleep states where the IC declares power good, starts the qualification charge at 22 mA, sets the charge current base on the ISET pin, and starts the safety timer.

8.4.3 Sleep Mode

If the IN pin voltage is between $V_{OUT} + V_{DT}$ and UVLO, the charge current is disabled, the safety timer counting stops (not reset). As the input voltage rises and the charger exits sleep mode, the safety timer continues to count and the charge is enabled. See [Figure 22](#).

8.4.4 New Charge Cycle

A new charge cycle is started when a good power source is applied, performing a chip disable/enable (TS pin), exiting Termination and Timer Disable Mode (TTDM), detecting a battery insertion or the OUT voltage dropping below the VRCH threshold.

Device Functional Modes (continued)

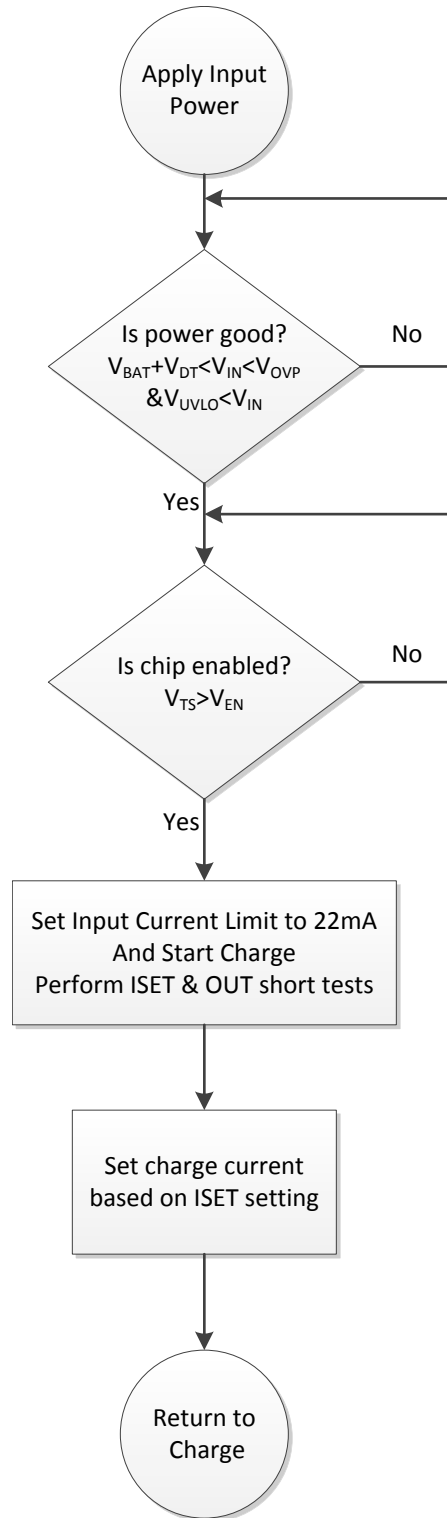

Figure 22. bq2510x Power-Up Flow Diagram

Device Functional Modes (continued)

8.4.5 Termination and Timer Disable Mode (TTDM) - TS Pin High

The battery charger is in TTDM when the TS pin goes high from removing the thermistor (removing battery pack/floating the TS pin) or by pulling the TS pin up to the TTDM threshold.

When entering TTDM, the 10 hour safety timer is held in reset and termination is disabled. A battery detect routine is run to see if the battery was removed or not. For bq25101/1H, if the battery was removed then the $\overline{\text{CHG}}$ pin will go to its high impedance state if not already there. If a battery is detected the $\overline{\text{CHG}}$ pin does not change states until the current tapers to the termination threshold, where the $\overline{\text{CHG}}$ pin goes to its high impedance state if not already there (the regulated output will remain on).

The charging profile does not change (still has pre-charge, fast-charge constant current and constant voltage modes). This implies the battery is still charged safely and the current is allowed to taper to zero.

When coming out of TTDM, the battery detect routine is run and if a battery is detected, then a new charge cycle begins.

If TTDM is not desired upon removing the battery with the thermistor, one can add a 237-k Ω resistor between TS and V_{SS} to disable TTDM. This keeps the current source from driving the TS pin into TTDM. This creates $\pm 0.1^{\circ}\text{C}$ error at hot and a $\pm 3^{\circ}\text{C}$ error at cold.

8.4.6 Battery Detect Routine

The battery detect routine should check for a missing battery while keeping the OUT pin at a useable voltage.

The battery detect routine is run when entering and exiting TTDM to verify if battery is present, or run all the time if battery is missing and not in TTDM. On power-up, if battery voltage is greater than V_{RCH} threshold, a battery detect routine is run to determine if a battery is present.

The battery detect routine is disabled while the IC is in TTDM, or has a TS fault. See [Figure 23](#) for the Battery Detect Flow Diagram.

8.4.7 Refresh Threshold

After termination, if the OUT pin voltage drops to V_{RCH} (100mV below regulation) then a new charge is initiated.

8.4.8 Starting a Charge on a Full Battery

The termination threshold is raised by $\pm 14\%$ for the first minute of a charge cycle so if a full battery is removed and reinserted or a new charge cycle is initiated, that the new charge terminates (less than 1 minute). Batteries that have relaxed many hours may take several minutes to taper to the termination threshold and terminate charge.

Device Functional Modes (continued)

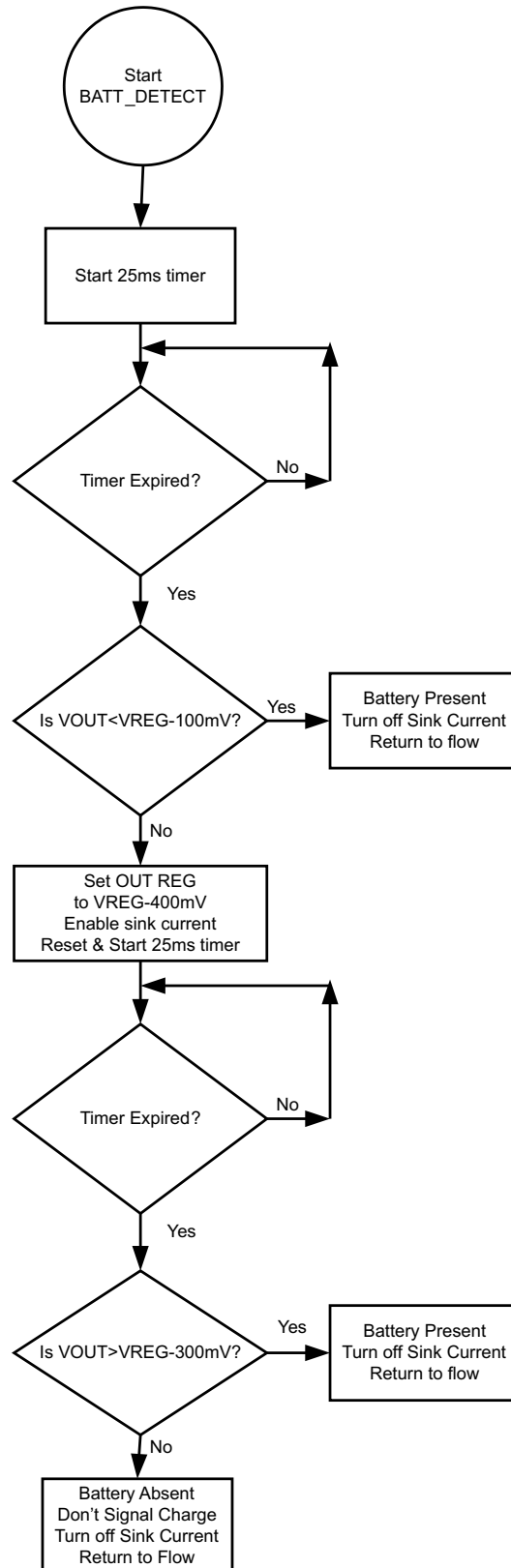

Figure 23. Battery Detect Routine

9 Application and Implementation

NOTE

Information in the following applications sections is not part of the TI component specification, and TI does not warrant its accuracy or completeness. TI's customers are responsible for determining suitability of components for their purposes. Customers should validate and test their design implementation to confirm system functionality.

9.1 Application Information

The bq2510x series of devices are highly integrated Li-Ion and Li-Pol linear chargers targeted at space-limited portable applications. The fast charge current can be programmed from 10 mA to 250 mA through an external resistor on ISET pin. The pre_charge and termination current can also be programmed through the resistor connected on PRETERM pin. The device has complete system-level protection such as input under-voltage lockout (UVLO), input over-voltage protection (OVP), sleep mode, thermal regulation, safety timers, and NTC monitoring input.

9.2 Typical Application - Charger Application Design Example

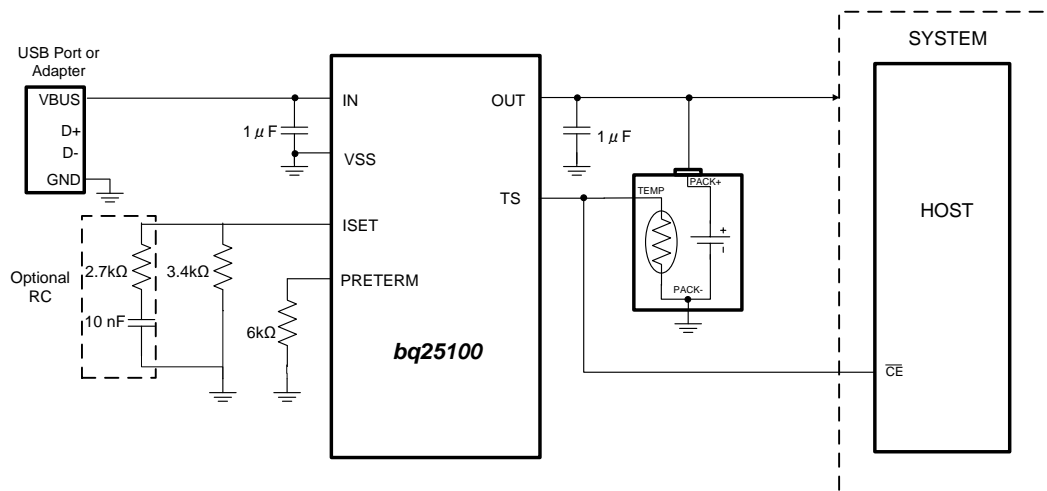

9.2.1 Design Requirements

- Supply voltage = 5 V
- Fast charge current: $I_{OUT-FC} = 40 \text{ mA}$;
- Termination Current Threshold: $\%I_{OUT-FC} = 10\%$ of Fast Charge or $\sim 4 \text{ mA}$
- Pre-Charge Current by default is twice the termination Current or $\sim 8 \text{ mA}$
- TS – Battery Temperature Sense = 10-k NTC (103AT)
- /CE is an open drain control pin

9.2.2 Detailed Design Procedures

- The regulation voltage is set to 4.2 V, the input voltage is 5 V and the charge current is programmed to 40 mA.
- For charge current that is below 50 mA, an extra RC circuit is recommended on ISET to achieve more stable current signal. For applications that need higher charge current, the RC circuit is not needed.
- For applications that use more than 200-mA current, there could be a very low level $\sim 1\%$ of charge current ringing in the output. The ringing can be removed by increasing the input capacitance.

Typical Application - Charger Application Design Example (continued)

9.2.2.1 Calculations

9.2.2.1.1 Program the Fast Charge Current, ISET:

$$R_{ISET} = [K_{(ISET)} / I_{(OUT)}]$$

from electrical characteristics table. . . $K_{(SET)} = 135 \text{ A}\Omega$

$$R_{ISET} = [135 \text{ A}\Omega / 0.04 \text{ A}] = 3.4 \text{ k}\Omega$$

Selecting the closest standard value, use a 3.4-k Ω resistor between ISET and Vss.

9.2.2.1.2 Program the Termination Current Threshold, ITERM:

$$R_{PRE-TERM} = K_{(TERM)} \times \%_{IOUT-FC}$$

$$R_{PRE-TERM} = 600 \text{ }\Omega/\% \times 10\% = 6 \text{ k}\Omega$$

Selecting the closest standard value, use a 6-k Ω resistor between PRETERM and Vss.

One can arrive at the same value by using 20% for a pre-charge value (factor of 2 difference).

$$R_{PRE-TERM} = K_{(PRE-CHG)} \times \%_{IOUT-FC}$$

$$R_{PRE-TERM} = 300 \text{ }\Omega/\% \times 20\% = 6 \text{ k}\Omega$$

9.2.2.1.3 TS Function

Use a 10-k NTC thermistor in the battery pack (103AT).

To Disable the temp sense function, use a fixed 10-k Ω resistor between the TS and VSS.

9.2.2.1.4 Selecting IN and OUT Pin Capacitors

In most applications, all that is needed is a high-frequency decoupling capacitor (ceramic) on the power pin, input and output pins. Using the values shown on the application diagram is recommended. After evaluation of these voltage signals with real system operational conditions, one can determine if capacitance values can be adjusted toward the minimum recommended values (DC load application) or higher values for fast, high amplitude, pulsed load applications. Note if designed for high input voltage sources (bad adaptors or wrong adaptors), the capacitor needs to be rated appropriately. Ceramic capacitors are tested to 2x their rated values so a 16-V capacitor may be adequate for a 30-V transient (verify tested rating with capacitor manufacturer).

9.2.3 bq25100 Application Performance Plots

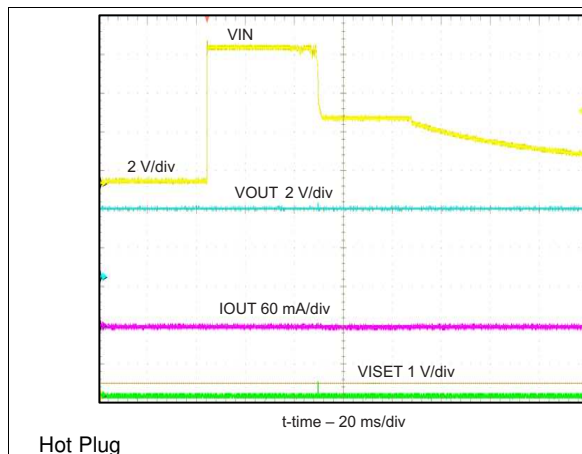

Hot Plug

Figure 24. OVP 7-V Adaptor

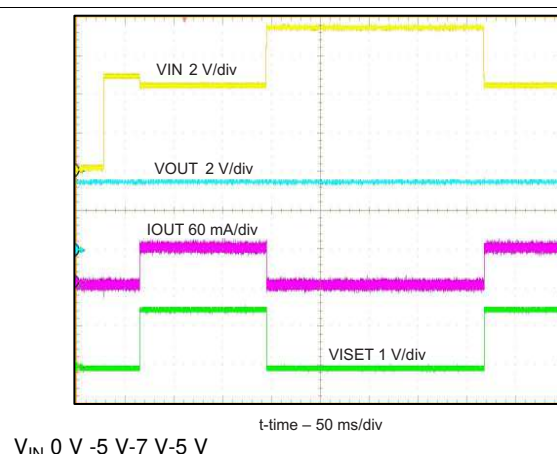

V_{IN} 0 V -5 V -7 V -5 V

Figure 25. OVP from Normal Power-Up Operation

Typical Application - Charger Application Design Example (continued)

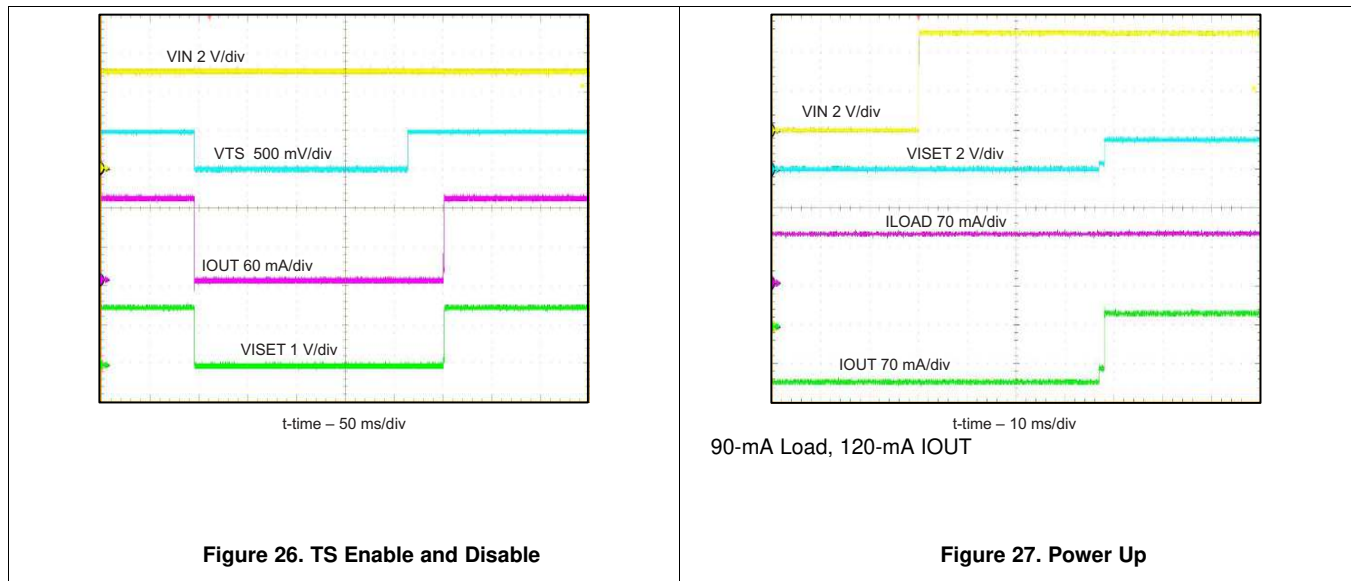
Figure 26. TS Enable and Disable
Figure 27. Power Up

10 Power Supply Recommendations

10.1 Leakage Current Effects on Battery Capacity

To determine how fast a leakage current on the battery will discharge the battery is an easy calculation. The time from full to discharge can be calculated by dividing the Amp-Hour Capacity of the battery by the leakage current. For a 0.1-AHr battery and a 75-nA leakage current ($100\text{mAhr}/75\text{nA} = 250000$ Hours), it would take 1333k hours or 152 years to discharge. In reality the self discharge of the cell would be much faster so the 75-nA leakage would be considered negligible.

11 Layout

11.1 Layout Guidelines

To obtain optimal performance, the decoupling capacitor from IN to GND and the output filter capacitors from OUT to GND should be placed as close as possible to the bq2510x, with short trace runs to both IN, OUT and GND.

- All low-current GND connections should be kept separate from the high-current charge or discharge paths from the battery. Use a single-point ground technique incorporating both the small signal ground path and the power ground path.
- The high current charge paths into IN pin and from the OUT pin must be sized appropriately for the maximum charge current in order to avoid voltage drops in these traces

11.2 Layout Example

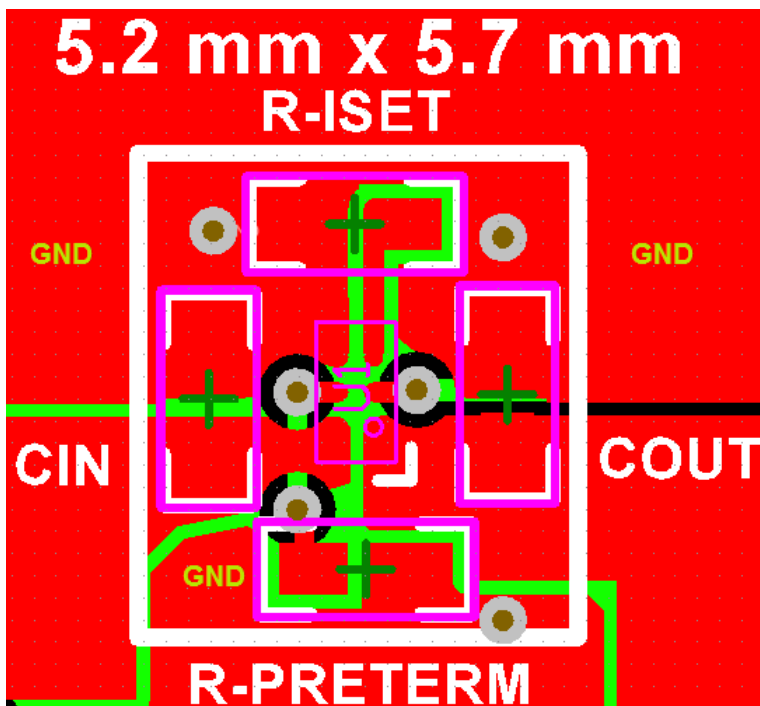

Figure 28. Board Layout

11.3 Thermal Package

The most common measure of package thermal performance is thermal impedance (θ_{JA}) measured (or modeled) from the chip junction to the air surrounding the package surface (ambient). The mathematical expression for θ_{JA} is:

$$\theta_{JA} = (T_J - T) / P \quad (3)$$

Where:

T_J = chip junction temperature

T = ambient temperature

P = device power dissipation

Factors that can influence the measurement and calculation of θ_{JA} include:

1. Whether or not the device is board mounted
2. Trace size, composition, thickness, and geometry
3. Orientation of the device (horizontal or vertical)
4. Volume of the ambient air surrounding the device under test and airflow
5. Whether other surfaces are in close proximity to the device being tested

Due to the charge profile of Li-Ion and Li-Pol batteries the maximum power dissipation is typically seen at the beginning of the charge cycle when the battery voltage is at its lowest. Typically after fast charge begins the pack voltage increases to ≈ 3.4 V within the first 2 minutes. The thermal time constant of the assembly typically takes a few minutes to heat up so when doing maximum power dissipation calculations, 3.4 V is a good minimum voltage to use.

The device power dissipation, P , is a function of the charge rate and the voltage drop across the internal PowerFET. It can be calculated from the following equation when a battery pack is being charged :

$$P = [V_{(IN)} - V_{(OUT)}] \times I_{(OUT)} \quad (4)$$

Thermal Package (continued)

The thermal loop feature reduces the charge current to limit excessive IC junction temperature. It is recommended that the design not run in thermal regulation for typical operating conditions (nominal input voltage and nominal ambient temperatures) and use the feature for non typical situations such as hot environments or higher than normal input source voltage. With that said, the IC will still perform as described, if the thermal loop is always active.

12 Device and Documentation Support

12.1 Device Support

12.1.1 Third-Party Products Disclaimer

TI'S PUBLICATION OF INFORMATION REGARDING THIRD-PARTY PRODUCTS OR SERVICES DOES NOT CONSTITUTE AN ENDORSEMENT REGARDING THE SUITABILITY OF SUCH PRODUCTS OR SERVICES OR A WARRANTY, REPRESENTATION OR ENDORSEMENT OF SUCH PRODUCTS OR SERVICES, EITHER ALONE OR IN COMBINATION WITH ANY TI PRODUCT OR SERVICE.

12.2 Related Links

The table below lists quick access links. Categories include technical documents, support and community resources, tools and software, and quick access to sample or buy.

Table 1. Related Links

PARTS	PRODUCT FOLDER	SAMPLE & BUY	TECHNICAL DOCUMENTS	TOOLS & SOFTWARE	SUPPORT & COMMUNITY
bq25100	Click here	Click here	Click here	Click here	Click here
bq25101	Click here	Click here	Click here	Click here	Click here
bq25100A	Click here	Click here	Click here	Click here	Click here
bq25100H	Click here	Click here	Click here	Click here	Click here
bq25101H	Click here	Click here	Click here	Click here	Click here
bq25100L	Click here	Click here	Click here	Click here	Click here

12.3 Trademarks

Bluetooth is a registered trademark of Bluetooth SIG, Inc..

12.4 Electrostatic Discharge Caution



These devices have limited built-in ESD protection. The leads should be shorted together or the device placed in conductive foam during storage or handling to prevent electrostatic damage to the MOS gates.

12.5 Glossary

[SLYZ022](#) — *TI Glossary*.

This glossary lists and explains terms, acronyms, and definitions.

13 Mechanical, Packaging, and Orderable Information

The following pages include mechanical, packaging, and orderable information. This information is the most current data available for the designated devices. This data is subject to change without notice and revision of this document. For browser-based versions of this data sheet, refer to the left-hand navigation.

PACKAGING INFORMATION

Orderable Device	Status (1)	Package Type	Package Drawing	Pins	Package Qty	Eco Plan (2)	Lead finish/ Ball material (6)	MSL Peak Temp (3)	Op Temp (°C)	Device Marking (4/5)	Samples
BQ25100AYFPR	ACTIVE	DSBGA	YFP	6	3000	RoHS & Green	SNAGCU	Level-1-260C-UNLIM	-40 to 85	25100A	Samples
BQ25100AYFPT	ACTIVE	DSBGA	YFP	6	250	RoHS & Green	SNAGCU	Level-1-260C-UNLIM	-40 to 85	25100A	Samples
BQ25100HYFPR	ACTIVE	DSBGA	YFP	6	3000	RoHS & Green	SNAGCU	Level-1-260C-UNLIM	0 to 125	25100H	Samples
BQ25100HYFPT	ACTIVE	DSBGA	YFP	6	250	RoHS & Green	SNAGCU	Level-1-260C-UNLIM	0 to 125	25100H	Samples
BQ25100YFPR	ACTIVE	DSBGA	YFP	6	3000	RoHS & Green	SNAGCU	Level-1-260C-UNLIM	0 to 125	25100	Samples
BQ25100YFPT	ACTIVE	DSBGA	YFP	6	250	RoHS & Green	SNAGCU	Level-1-260C-UNLIM	0 to 125	25100	Samples
BQ25101HYFPR	ACTIVE	DSBGA	YFP	6	3000	RoHS & Green	SNAGCU	Level-1-260C-UNLIM	0 to 125	25101H	Samples
BQ25101HYFPT	ACTIVE	DSBGA	YFP	6	250	RoHS & Green	SNAGCU	Level-1-260C-UNLIM	0 to 125	25101H	Samples
BQ25101YFPR	ACTIVE	DSBGA	YFP	6	3000	RoHS & Green	SNAGCU	Level-1-260C-UNLIM	0 to 125	25101	Samples
BQ25101YFPT	ACTIVE	DSBGA	YFP	6	250	RoHS & Green	SNAGCU	Level-1-260C-UNLIM	0 to 125	25101	Samples

(1) The marketing status values are defined as follows:

ACTIVE: Product device recommended for new designs.

LIFEBUY: TI has announced that the device will be discontinued, and a lifetime-buy period is in effect.

NRND: Not recommended for new designs. Device is in production to support existing customers, but TI does not recommend using this part in a new design.

PREVIEW: Device has been announced but is not in production. Samples may or may not be available.

OBSOLETE: TI has discontinued the production of the device.

(2) **RoHS:** TI defines "RoHS" to mean semiconductor products that are compliant with the current EU RoHS requirements for all 10 RoHS substances, including the requirement that RoHS substance do not exceed 0.1% by weight in homogeneous materials. Where designed to be soldered at high temperatures, "RoHS" products are suitable for use in specified lead-free processes. TI may reference these types of products as "Pb-Free".

RoHS Exempt: TI defines "RoHS Exempt" to mean products that contain lead but are compliant with EU RoHS pursuant to a specific EU RoHS exemption.

Green: TI defines "Green" to mean the content of Chlorine (Cl) and Bromine (Br) based flame retardants meet JS709B low halogen requirements of <=1000ppm threshold. Antimony trioxide based flame retardants must also meet the <=1000ppm threshold requirement.

(3) MSL, Peak Temp. - The Moisture Sensitivity Level rating according to the JEDEC industry standard classifications, and peak solder temperature.

(4) There may be additional marking, which relates to the logo, the lot trace code information, or the environmental category on the device.

⁽⁵⁾ Multiple Device Markings will be inside parentheses. Only one Device Marking contained in parentheses and separated by a "~" will appear on a device. If a line is indented then it is a continuation of the previous line and the two combined represent the entire Device Marking for that device.

⁽⁶⁾ Lead finish/Ball material - Orderable Devices may have multiple material finish options. Finish options are separated by a vertical ruled line. Lead finish/Ball material values may wrap to two lines if the finish value exceeds the maximum column width.

Important Information and Disclaimer:The information provided on this page represents TI's knowledge and belief as of the date that it is provided. TI bases its knowledge and belief on information provided by third parties, and makes no representation or warranty as to the accuracy of such information. Efforts are underway to better integrate information from third parties. TI has taken and continues to take reasonable steps to provide representative and accurate information but may not have conducted destructive testing or chemical analysis on incoming materials and chemicals. TI and TI suppliers consider certain information to be proprietary, and thus CAS numbers and other limited information may not be available for release.

In no event shall TI's liability arising out of such information exceed the total purchase price of the TI part(s) at issue in this document sold by TI to Customer on an annual basis.

TAPE AND REEL INFORMATION



QUADRANT ASSIGNMENTS FOR PIN 1 ORIENTATION IN TAPE



*All dimensions are nominal

Device	Package Type	Package Drawing	Pins	SPQ	Reel Diameter (mm)	Reel Width W1 (mm)	A0 (mm)	B0 (mm)	K0 (mm)	P1 (mm)	W (mm)	Pin1 Quadrant
BQ25100AYFPR	DSBGA	YFP	6	3000	180.0	8.4	0.98	1.68	0.59	4.0	8.0	Q1
BQ25100AYFPT	DSBGA	YFP	6	250	180.0	8.4	0.98	1.68	0.59	4.0	8.0	Q1
BQ25100HYFPR	DSBGA	YFP	6	3000	180.0	8.4	0.98	1.68	0.59	4.0	8.0	Q1
BQ25100HYFPT	DSBGA	YFP	6	250	180.0	8.4	0.98	1.68	0.59	4.0	8.0	Q1
BQ25100YFPR	DSBGA	YFP	6	3000	180.0	8.4	0.98	1.68	0.59	4.0	8.0	Q1
BQ25100YFPT	DSBGA	YFP	6	250	180.0	8.4	0.98	1.68	0.59	4.0	8.0	Q1
BQ25101HYFPR	DSBGA	YFP	6	3000	180.0	8.4	0.98	1.68	0.59	4.0	8.0	Q1
BQ25101HYFPT	DSBGA	YFP	6	250	180.0	8.4	0.98	1.68	0.59	4.0	8.0	Q1
BQ25101YFPR	DSBGA	YFP	6	3000	180.0	8.4	0.98	1.68	0.59	4.0	8.0	Q1
BQ25101YFPT	DSBGA	YFP	6	250	180.0	8.4	0.98	1.68	0.59	4.0	8.0	Q1

TAPE AND REEL BOX DIMENSIONS

*All dimensions are nominal

Device	Package Type	Package Drawing	Pins	SPQ	Length (mm)	Width (mm)	Height (mm)
BQ25100AYFPR	DSBGA	YFP	6	3000	182.0	182.0	20.0
BQ25100AYFPT	DSBGA	YFP	6	250	182.0	182.0	20.0
BQ25100HYFPR	DSBGA	YFP	6	3000	182.0	182.0	20.0
BQ25100HYFPT	DSBGA	YFP	6	250	182.0	182.0	20.0
BQ25100YFPR	DSBGA	YFP	6	3000	182.0	182.0	20.0
BQ25100YFPT	DSBGA	YFP	6	250	182.0	182.0	20.0
BQ25101HYFPR	DSBGA	YFP	6	3000	182.0	182.0	20.0
BQ25101HYFPT	DSBGA	YFP	6	250	182.0	182.0	20.0
BQ25101YFPR	DSBGA	YFP	6	3000	182.0	182.0	20.0
BQ25101YFPT	DSBGA	YFP	6	250	182.0	182.0	20.0

YFP0006

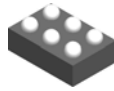

PACKAGE OUTLINE

DSBGA - 0.5 mm max height

DIE SIZE BALL GRID ARRAY

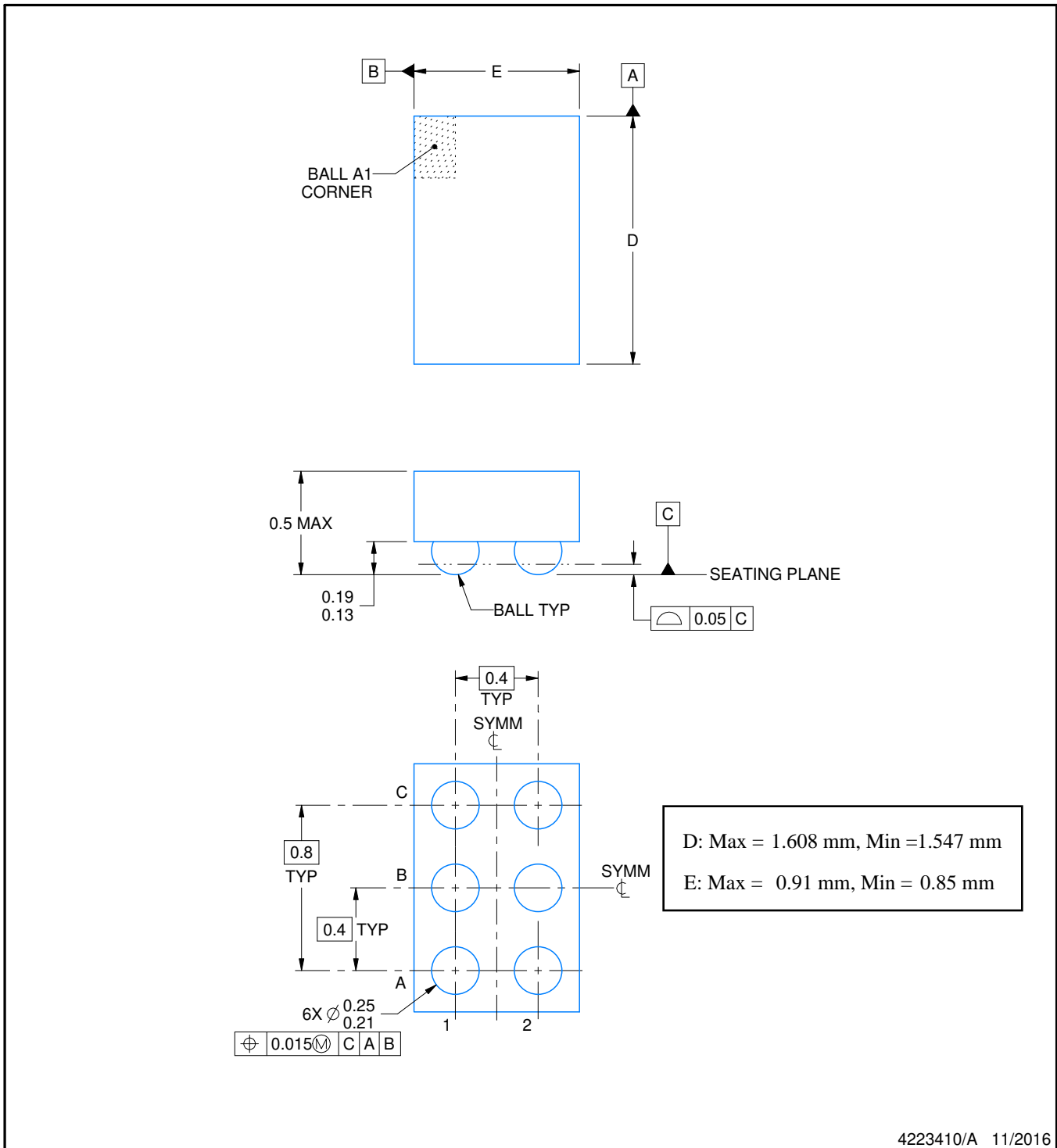

4223410/A 11/2016

NOTES:

1. All linear dimensions are in millimeters. Any dimensions in parenthesis are for reference only. Dimensioning and tolerancing per ASME Y14.5M.
2. This drawing is subject to change without notice.

EXAMPLE BOARD LAYOUT

YFP0006

DSBGA - 0.5 mm max height

DIE SIZE BALL GRID ARRAY

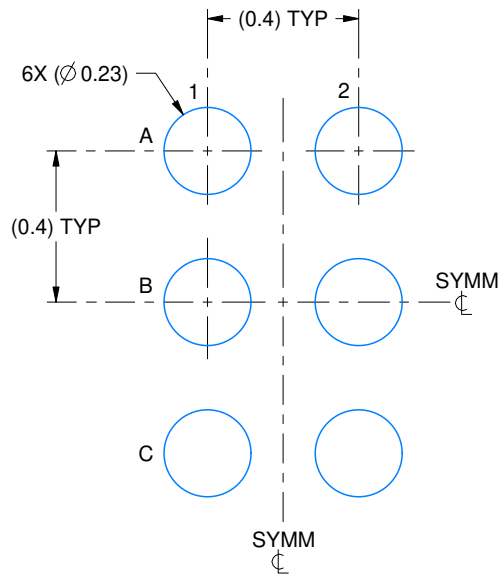

LAND PATTERN EXAMPLE
SCALE:50X

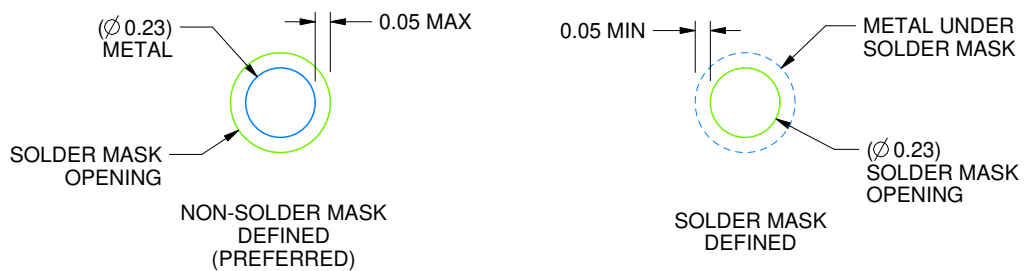

SOLDER MASK DETAILS
NOT TO SCALE

4223410/A 11/2016

NOTES: (continued)

- Final dimensions may vary due to manufacturing tolerance considerations and also routing constraints. For more information, see Texas Instruments literature number SNVA009 (www.ti.com/lit/snva009).

EXAMPLE STENCIL DESIGN

YFP0006

DSBGA - 0.5 mm max height

DIE SIZE BALL GRID ARRAY

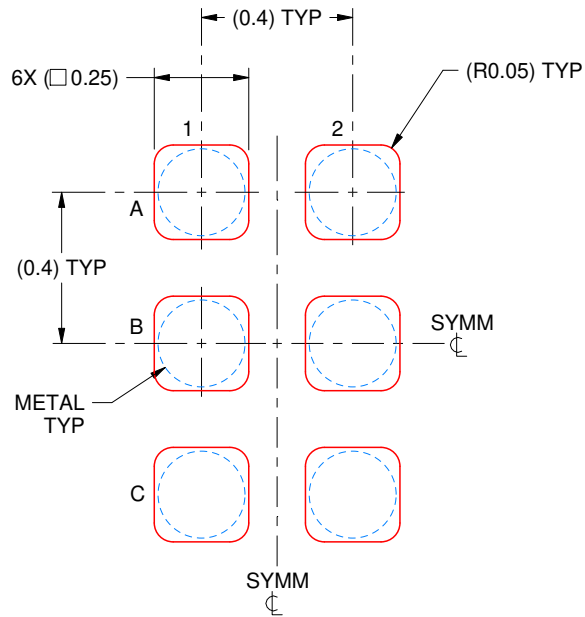

SOLDER PASTE EXAMPLE
BASED ON 0.1 mm THICK STENCIL
SCALE:50X

4223410/A 11/2016

NOTES: (continued)

4. Laser cutting apertures with trapezoidal walls and rounded corners may offer better paste release.

IMPORTANT NOTICE AND DISCLAIMER

TI PROVIDES TECHNICAL AND RELIABILITY DATA (INCLUDING DATA SHEETS), DESIGN RESOURCES (INCLUDING REFERENCE DESIGNS), APPLICATION OR OTHER DESIGN ADVICE, WEB TOOLS, SAFETY INFORMATION, AND OTHER RESOURCES "AS IS" AND WITH ALL FAULTS, AND DISCLAIMS ALL WARRANTIES, EXPRESS AND IMPLIED, INCLUDING WITHOUT LIMITATION ANY IMPLIED WARRANTIES OF MERCHANTABILITY, FITNESS FOR A PARTICULAR PURPOSE OR NON-INFRINGEMENT OF THIRD PARTY INTELLECTUAL PROPERTY RIGHTS.

These resources are intended for skilled developers designing with TI products. You are solely responsible for (1) selecting the appropriate TI products for your application, (2) designing, validating and testing your application, and (3) ensuring your application meets applicable standards, and any other safety, security, regulatory or other requirements.

These resources are subject to change without notice. TI grants you permission to use these resources only for development of an application that uses the TI products described in the resource. Other reproduction and display of these resources is prohibited. No license is granted to any other TI intellectual property right or to any third party intellectual property right. TI disclaims responsibility for, and you will fully indemnify TI and its representatives against, any claims, damages, costs, losses, and liabilities arising out of your use of these resources.

TI's products are provided subject to [TI's Terms of Sale](#) or other applicable terms available either on [ti.com](https://www.ti.com) or provided in conjunction with such TI products. TI's provision of these resources does not expand or otherwise alter TI's applicable warranties or warranty disclaimers for TI products.

TI objects to and rejects any additional or different terms you may have proposed.

Mailing Address: Texas Instruments, Post Office Box 655303, Dallas, Texas 75265
Copyright © 2023, Texas Instruments Incorporated