

Features

Clamping Surge Protector

- Surge protector (voltage clamp) for RIA12 and NF F01-510 transients
- Output follows input up to the clamp voltage
- Max. load = 20W, 150W or 300W
- -40°C to + 95°C Operating temperature
- Board-mount module

RSPxxx-168

20W-300W, 168V



Clamping Surge Protector

Description

The RSPxxx-168 is a surge protector module designed to protect DC/DC converters from railway over-voltage transients up to 385VDC.

The output voltage tracks the input voltage in the range of 40-165VDC, thereafter the output voltage is clamped to 168VDC.

The **RSP20-168** is a DIP24 module that can be simply inserted in series with the input of the RP08-110xxSAW, RP08-110xxDAW, RP20-110xxSFR and RP20-110xxDFR converter families to make them compliant to both RIA12 and NF F 01-510 surge immunity specifications.

The **RSP150-168** is a board-mount module that can be simply inserted in series with the input of the RP40-110xxSFR, RP40Q-110xxSRUW, RP60Q-110xxSRUW, RP75H-110xxSRW, RP90Q-110xxSRW, RPA100H-110xxSRUW, RPA120H-110xxSRW and RP120Q-110xxSRW converter families to make them compliant to both RIA12 and NF F 01-510 surge immunity specifications.

The **RSP300-168** is a board-mount module that can be simply inserted in series with the input of the RP180H-110xxSRW, RPA200H-110xxSRUW and RP240H-110xxSRW converter families to make them compliant to both RIA12 and NF F 01-510 surge immunity specifications.



Selection Guide

Part Number	Input Voltage Range [VDC]	Clamping Voltage [VDC]	Output Power Range [W]	Max. Input Voltage 20ms [VDC]
RSP20-168	40-160	168	0-20	385
RSP150-168	40-160	168	0-150	385
RSP300-168	40-160	168	0-300	385



compliant to RIA12 and NF F 01-510 Surge Susceptibility

Model Numbering

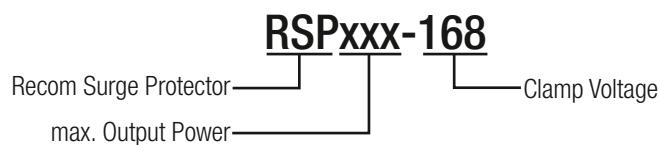

Specifications (measured @ Ta= 25°C, nom. Vin, full load and after warm-up unless otherwise stated)

BASIC CHARACTERISTICS

Parameter	Condition		Min.	Typ.	Max.
Input Voltage Range			40VDC	110VDC	160VDC
Minimum Operating Voltage				36VDC	
Transient Voltage	20ms max. 100ms max. 1s max.				385VDC 176VDC 165VDC
Continuous Power Range	RSP20-168 RSP150-168 RSP300-168		0W 0W 0W		20W 150W 300W
In-circuit Voltage Drop	100% load @ 110VDC	RSP20-168 RSP150-168 RSP300-168		40mV 70mV 300mV	

Transfer Function

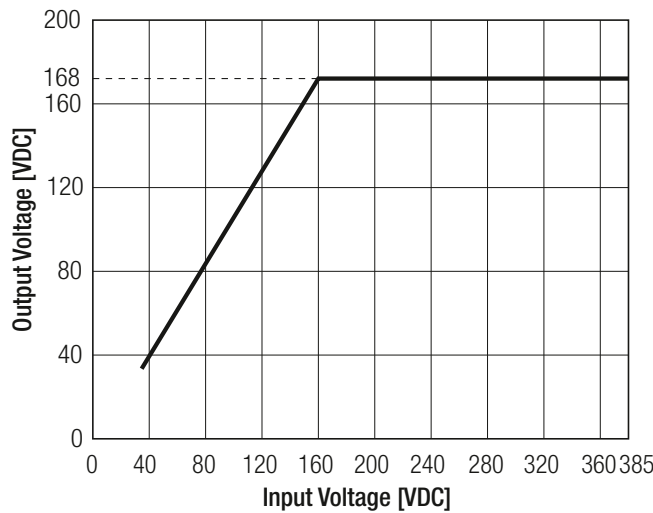

Input voltage:
 40V - 165V Pass through
 168V - 385V Clamp at 168V

PROTECTIONS

The surge protector can be used for 72V, 96V and 110V battery systems in railway applications. Input range of DC-DC converter also has to meet 72V, 96V and 110V system input range.

Nominal Input	EN50155 Standard			RIA12 Standard				with RSP	NF F 01-510 Standard			
	Permanent Input Range (0.7-1.25Vin)	Brownout 100ms (0.6Vin)	Transient 1s (1.4Vin)	Permanent Input Range (0.7-1.25Vin)	Brownout 100ms (0.6Vin)	Transient 1s (1.5Vin)	Transient 20ms (3.5Vin)		Permanent Input Range	Brownout 100ms (0.5Vin)	Transient 100ms	with RSP
72V	50.4-90V	43.2V	100.8V	50.4-90V	43.2V	112.5V	252V	168V	50-90V	36V	115V	115V
96V	67.2-120V	57.6V	134.4V	67.2-120V	57.6V	144V	336V	168V	-	-	-	-
110V	77-137.5V	66V	154V	77-137.5V	66V	165V	385V	168V	77-137V	55V	176V	168V

Notes:

Note1: For information about input fuse refer to Installation and Application on page P-5

continued on next page

Specifications (measured @ Ta= 25°C, nom. Vin, full load and after warm-up unless otherwise stated)

Protection Function

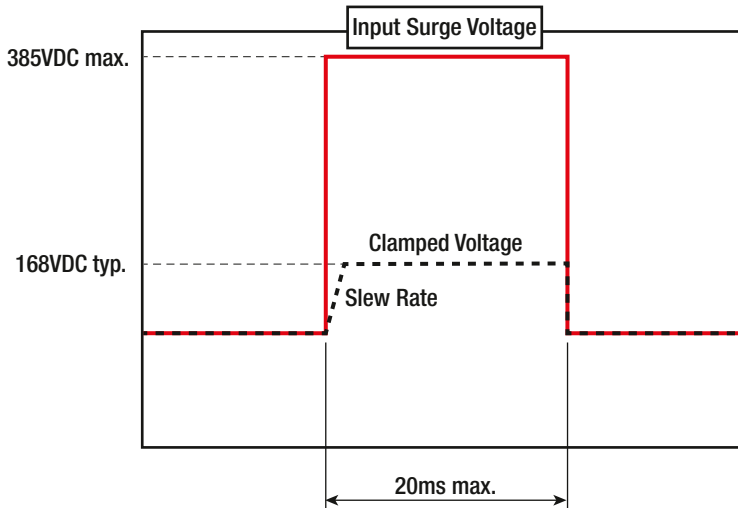
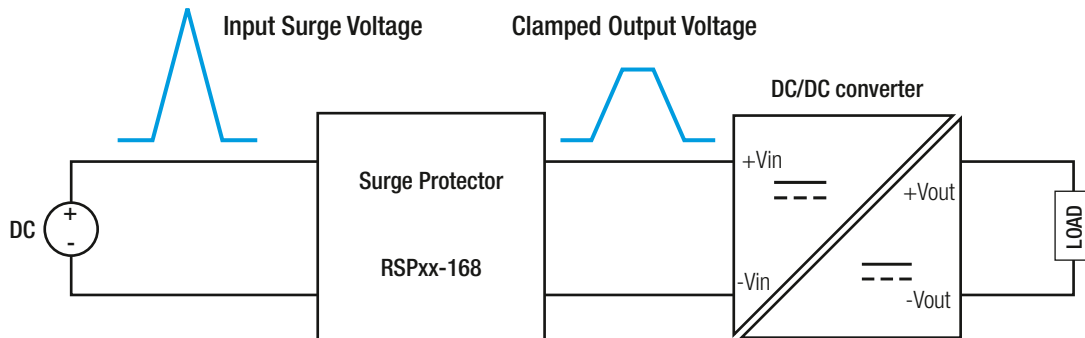

Slew Rate:
RSP20, RSP300 120V/ms
RSP150 100V/ms

Surge protector clamps over-voltage to a safe value in order to protect the power module from being damaged
According to RIA12, the module should keep working during input surge events.

ENVIRONMENTAL			
Parameter	Condition		Value
Operating Temperature Range	without derating @ natural convection 0.1m/s	RSP20-168	-40°C to +95°C
		RSP150-168	-40°C to +80°C
		RSP300-168	-40°C to +55°C
Maximum Case Temperature			+105°C
Operating Humidity	non-condensing		5% to 95% RH
Vibration			according to MIL-STD-810F standard
Thermal Shock			according to MIL-STD-810F standard

continued on next page

Specifications (measured @ Ta= 25°C, nom. Vin, full load and after warm-up unless otherwise stated)

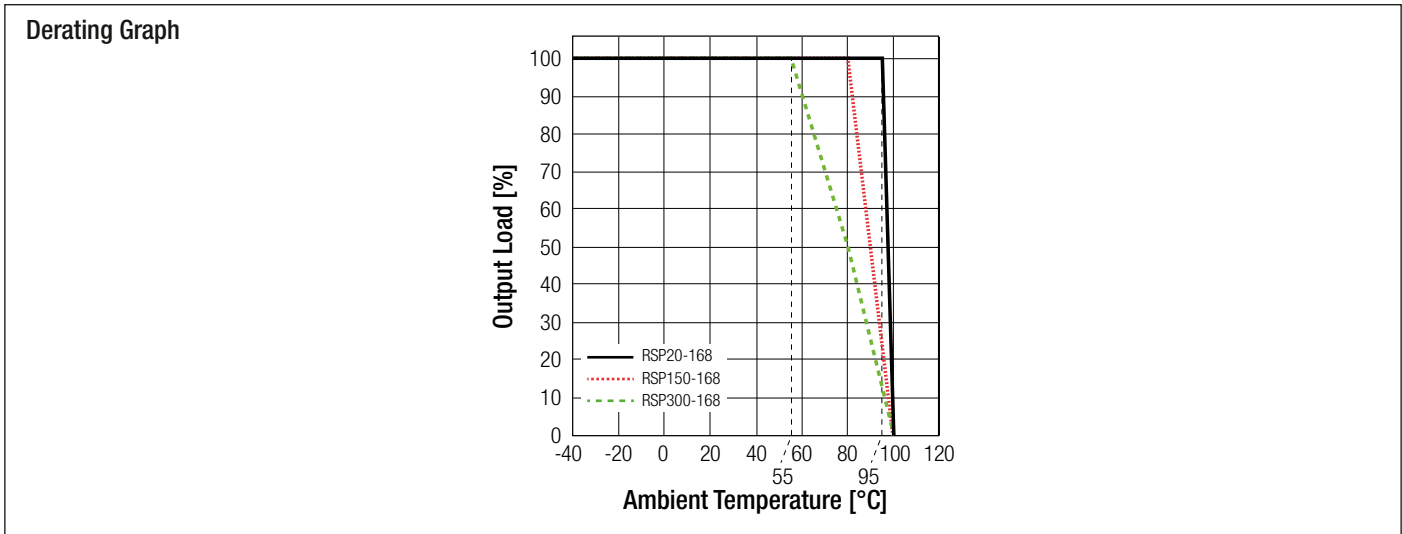

SAFETY AND CERTIFICATIONS COMPLIANCE	
Certificate Type (Safety)	Standard
General Specifications for Protection of Traction and Rolling Stock Electronic Equipment from Transients and Surges in DC Control Systems	meets UK BRB/RIA12
Railway Rolling Stock Environmental Conditions Sustained or Produced by Assemblies or Components in Vehicles	meets NF F 01-510

DIMENSION and PHYSICAL CHARACTERISTICS		
Parameter	Type	Value
Material	case potting base	non-conductive black plastic, (UL94 V-0) epoxy, (UL94 V-0) non-conductive black plastic, (UL94 V-0)
Package Dimension (LxWxH)	RSP20-168 RSP150-168 and RSP300-168	31.8 x 20.3 x 10.2mm 40.6 x 25.4 x 10.2mm
Package Weight	RSP20-168 RSP150-168 and RSP300-168	14g typ. 22g typ.

Dimension Drawing (mm)

RSP20-168

Pin Connections

Pin #	Single
1, 2	+Vin
10, 11, 12	+Vout
13, 14	-Vout
23, 24	-Vin

Pin Pitch Tolerance ±0.25mm
Pin dimension tolerance ±0.1mm
XX.X ± 0.5mm
XX.XX ± 0.25mm

Recommended Pad Layout:
Through hole Ø0.70mm
Pad Size Ø1.30mm

Specifications (measured @ Ta= 25°C, nom. Vin, full load and after warm-up unless otherwise stated)

RSP150-168 and RSP300-168

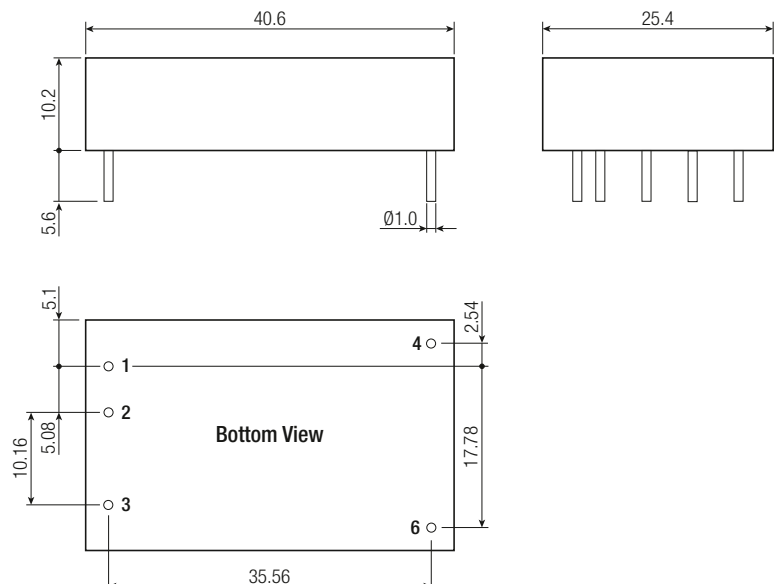

Pin Connections	
Pin #	Single
1	+Vin
2	NC
3	-Vin
4	+Vout
6	-Vout

Pin Pitch Tolerance $\pm 0.25\text{mm}$
 Pin dimension tolerance $\pm 0.1\text{mm}$
 XX.X $\pm 0.5\text{mm}$
 XX.XX $\pm 0.25\text{mm}$
Recommended Pad Layout:
 Through hole $\varnothing 1.20\text{mm}$
 Pad Size $\varnothing 3.00\text{mm}$

INSTALLATION and APPLICATION

Schematic for typical application

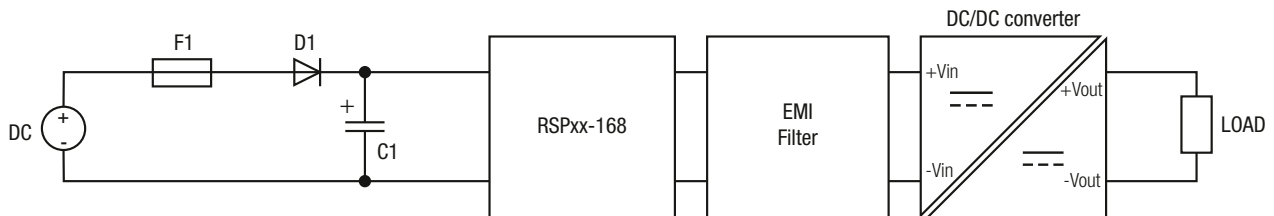

F1: An input fuse is required if the supply is not over-current protected
 D1: Reverse Polarity Protection
 C1: Hold up Capacitor

PACKAGING INFORMATION

Parameter	Type		Value
Packaging Dimension (LxWxH)	tube	RSP20-168	255.0 x 21.8 x 16.5mm
		RSP150-168 and RSP300-168	290.0 x 43.5 x 19.7mm
Packaging Quantity	RSP20-168		7pcs
	RSP150-168 and RSP300-168		10pcs
Storage Temperature Range			-55°C to +125°C
Storage Humidity	non-condensing		5% to 95% RH

The product information and specifications may be subject to changes even without prior written notice. The product has been designed for various applications; its suitability lies in the responsibility of each customer. The products are not authorized for use in safety-critical applications without RECOM's explicit written consent. A safety-critical application is an application where a failure may reasonably be expected to endanger or cause loss of life, inflict bodily harm or damage property. The applicant shall indemnify and hold harmless RECOM, its affiliated companies and its representatives against any damage claims in connection with the unauthorized use of RECOM products in such safety-critical applications.