

# ENERGIZER LN92 Industrial

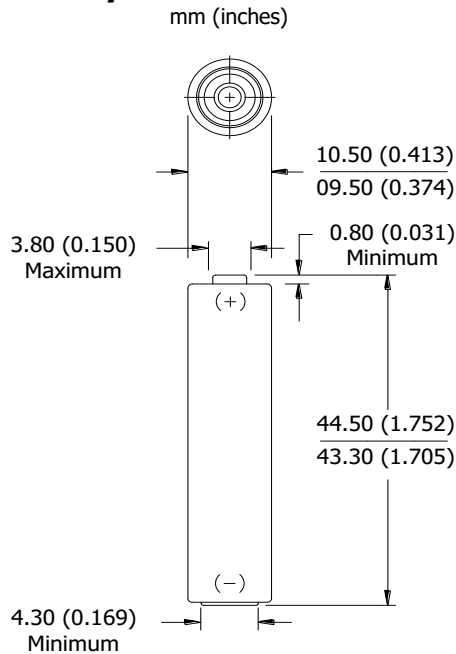



## Industry Standard Dimensions



**AAA**

## General Information

<b>Classification:</b>	Primary Lithium
<b>Chemical System:</b>	Lithium/Iron Disulfide (Li/FeS <sub>2</sub> )
<b>Designation:</b>	ANSI 24-LF, IEC-FR03
<b>Nominal Voltage:</b>	1.5 Volts
<b>Compatible With:</b>	<a href="#">E92</a> , <a href="#">NH12</a> , <a href="#">1212</a>
<b>Storage Temp:</b>	-40°C to 60°C (-40°F to 140°F)
<b>Operating Temp:</b>	-40°C to 60°C (-40°F to 140°F)*
<b>Typical Weight:</b>	7.6 grams (0.3 oz.)
<b>Typical Volume:</b>	3.8 cubic centimeters (0.2 cubic inch)
<b>Max Discharge:</b>	1.5 Amps Continuous
(single battery only)	2.0 Amps Pulse (2 sec on / 8 sec off)
<b>Max Rev Current:</b>	2 uA
<b>Lithium Content:</b>	Less than 1 gram
<b>Typical IR:</b>	140 to 180 milliohms (depending on method)
<b>Shelf Life:</b>	20 years at 21°C
<b>Shipping:</b>	<a href="#">Please refer to PSDS Document</a>
<b>Certifications:</b>	 

**\*All data shown tested at 21°C unless otherwise stated.**

## Milliamp-Hours Capacity

Constant Current Discharge to 0.8 Volts

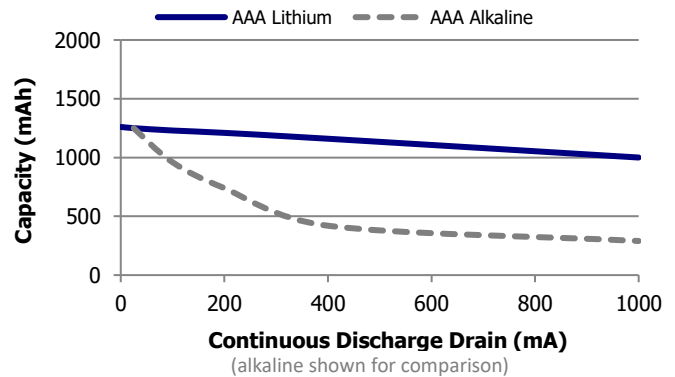

## Discharge Profile

Constant Current Discharge

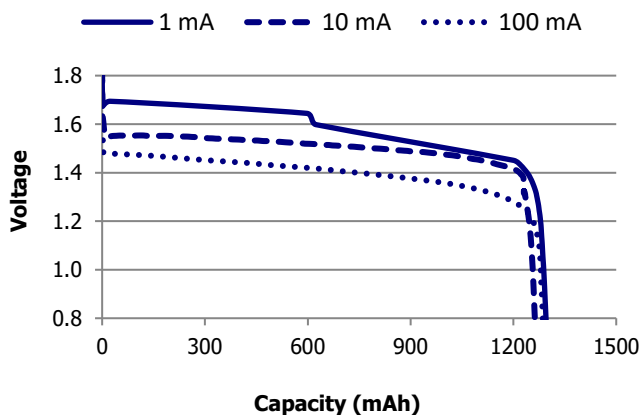

## Temperature Effects on Capacity

Constant Current Discharge

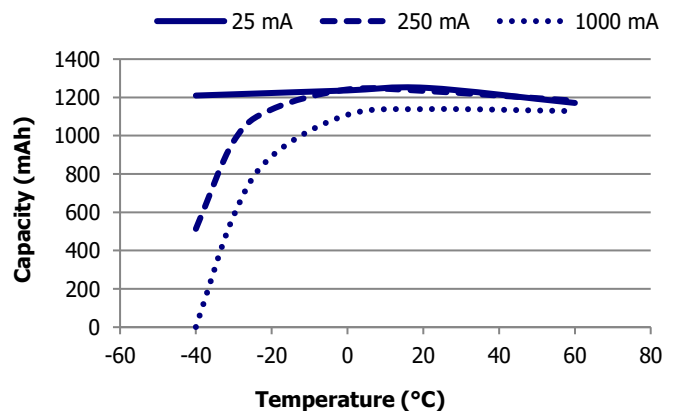

## Important Notice

This datasheet contains typical information specific to products manufactured at the time of its publication.  
**Contents herein do not constitute a warranty and are for reference only.**

# Industrial LN92

AAA

## Internal Resistance Profile

Cell Ohmic Resistance

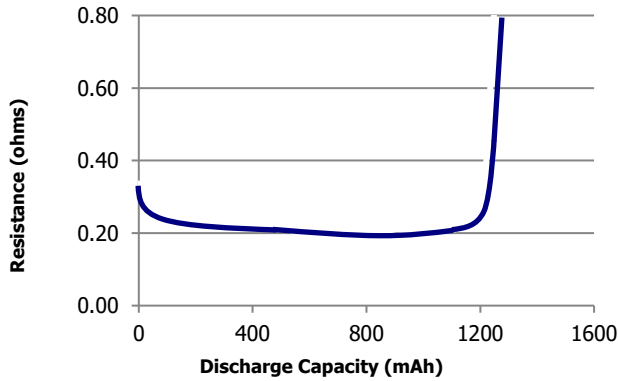

## Pulse Response

Open Circuit Voltage - 100/500/1k mA Pulse

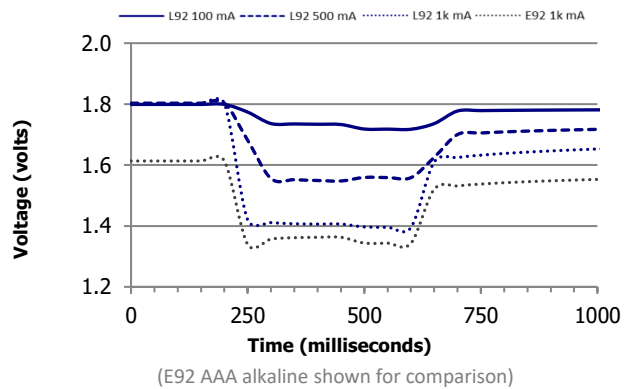

## Constant Power Performance

Typical Characteristics to 0.8 Volts

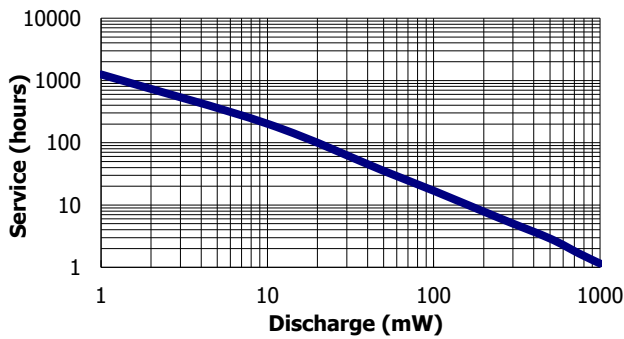

## Constant Current Performance

Typical Characteristics to 0.8 Volts

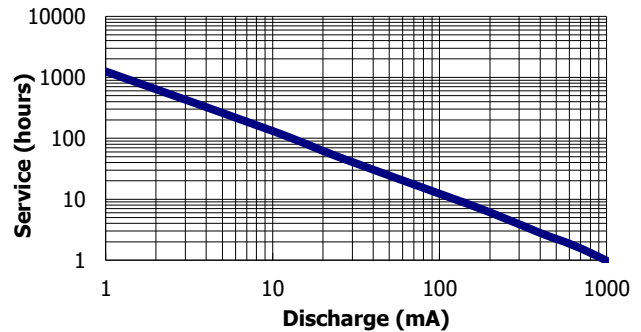

## Application Tests

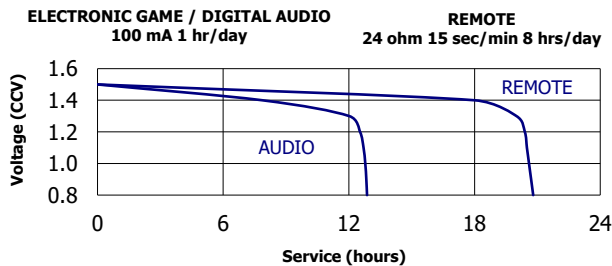

## Industry Standard Tests

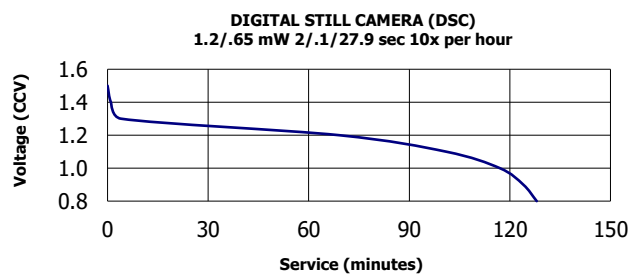
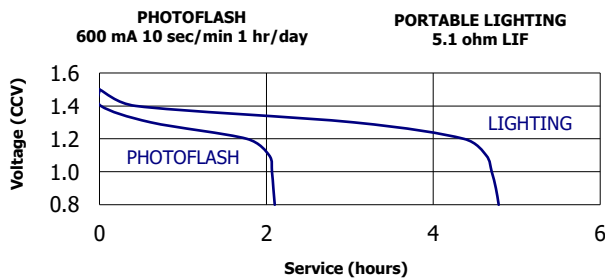
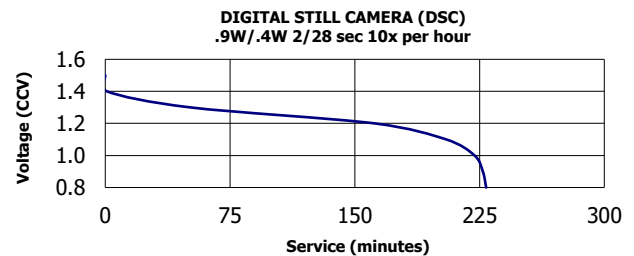

### Important Notice

This datasheet contains typical information specific to products manufactured at the time of its publication. **Contents herein do not constitute a warranty and are for reference only.**