

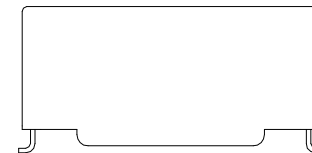

NOTES:

1. ROHS COMPLIANT
2. HEADER: DAP (DIALLYL PHTHALATE) WITH FLAMMABILITY RATING UL 94V-0 OR BETTER.
3. STORAGE TEMPERATURE: -20°C TO +125°C
4. COMPLIANCE TO J-STD:
 - A. J-STD-002: SOLDERABILITY AT 245°C REFLOW PROFILE
 - B. J-STD-020: MOISTURE SENSITIVE LEVEL 1
 - C. J-STD-075: R7, 245°C MAXIMUM THROUGH REFLOW SOLDER
5. TO ORDER TAPE & REEL PACKAGING ADD A "T" SUFFIX TO THE PART NUMBER(i.e HD8006FNL BECOMES HD8006FNLT).

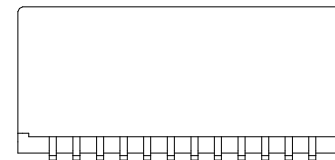
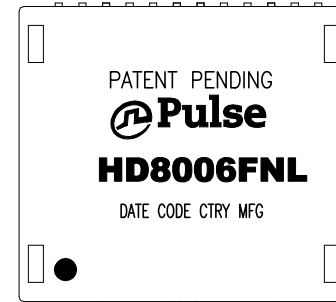

FINAL OUTLINE

© Copyright, 2023. Pulse Electronics Corp. All rights reserved. Pulse confidential & proprietary. (01/04/23)

PRODUCT DESCRIPTION	TLA DRAWING	PS DRAWING	SHEET	PART NO.	DATASHEET REV.
MDL,SIN,HDBT,1:1,SM,TU	HD8006FNL-11	PS-2790.001-D	1 OF 4	HD8006FNL	C

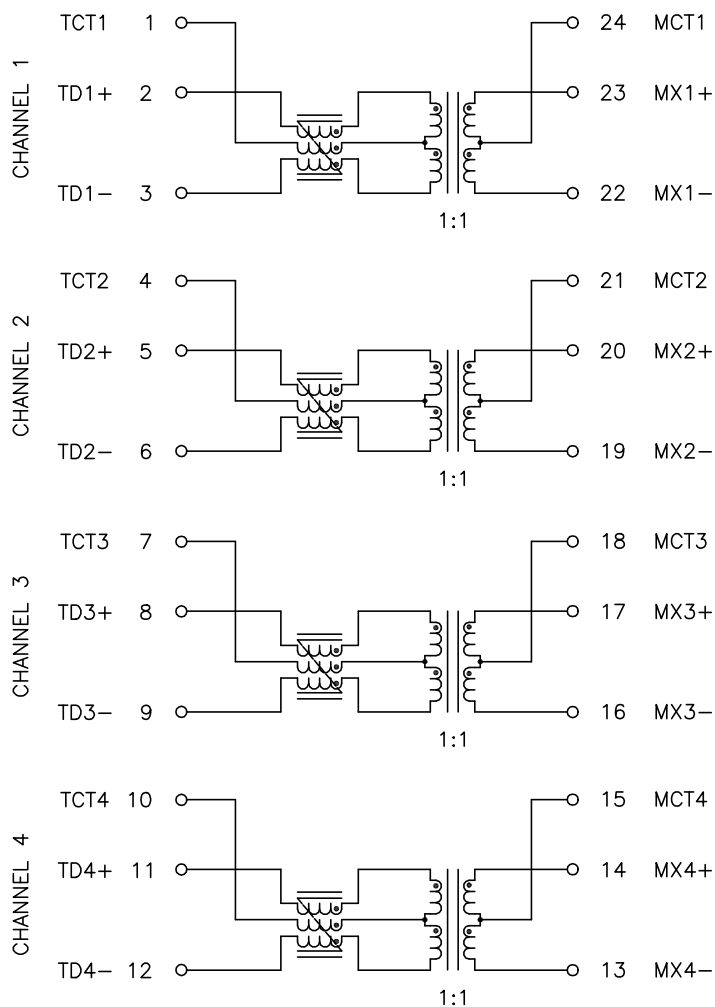

SCHEMATIC

ELECTRICAL CHARACTERISTICS AT +25°C UNLESS OTHER SPECIFIED
MEETS IEEE 802.3 SPECIFICATION

PARAMETER	SPECIFICATIONS				
OPERATING TEMPERATURE	0°C TO +70°C				
TURNS RATIO	1.00 ± 2%				
POLARITY	PER SCHEMATIC				
INSERTION LOSS (SDD21)	100 KHz	1-200 MHz	300 MHz	400 MHz	
	-3.0 dB MAX	-1.0 dB MAX	-1.2 dB MAX	-2.0 dB MAX	
PHY-SIDE RETURN LOSS (SDD11 - Zref = 100 OHMS ± 1%)	1 MHz	10 MHz-100 MHz	200 MHz	300 MHz	400 MHz
	-20.0 dB MIN	-22.0 dB MIN	-17.0 dB MIN	-13.5 dB MIN	-11.0 dB MIN
INDUCTANCE (OCL) (MEDIA SIDE, -0°C-+70°C)	120 uH MIN (MEASURED AT 100 KHz, 100 mVRMS AND WITH 22.5 mA DC BIAS)				
CROSSTALK, ADJACENT CHANNELS (SDD21 - ADJ.)	1-100 MHz		100-400 MHz		
	-40 dB MIN		-30 dB MIN		
COMMON MODE REJECTION RATIO (SCC21)	1 MHz-100 MHz		100-300 MHz	300-400 MHz	
	-37 dB MIN		-30 dB MIN	-25 dB MIN	
COMM. TO DIFF. REJECTION RATIO (SDC12)	1 MHz-100 MHz		100-300 MHz	300-400 MHz	
	-40 dB MIN		-30 dB MIN	-25 dB MIN	
DC RESISTANCE, 1/2 WINDING	.65 OHMS MAX				
DC CURRENT/VOLTAGE RATING	1500 mA MAX @ 57 V (CONTINUOUS)				
INPUT - OUTPUT ISOLATION	1500 VRMS MIN @ 60 SECONDS				

NOTE: f IS FREQUENCY IN MHz.

© Copyright, 2023. Pulse Electronics Corp. All rights reserved. Pulse confidential & proprietary. (01/04/23)

PRODUCT DESCRIPTION	TLA DRAWING	PS DRAWING	SHEET	PART NO.	DATASHEET REV.
MDL,SIN,HDBT,1:1,SM,TU	HD8006FNL-11	PS-2790.001-D	2 OF 4	HD8006FNL	C

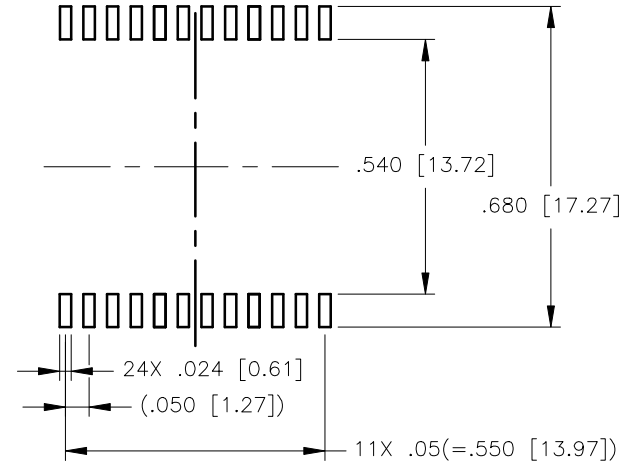
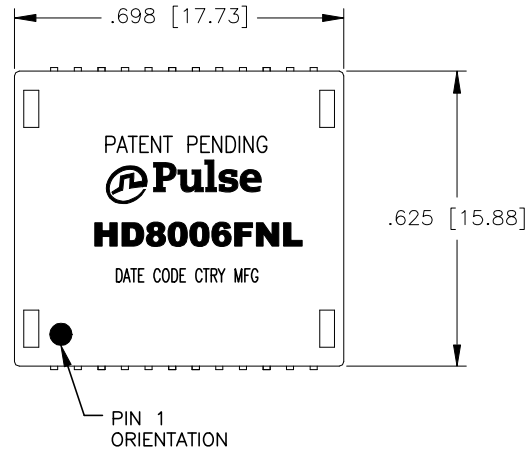

SUGGESTED LAND PATTERN

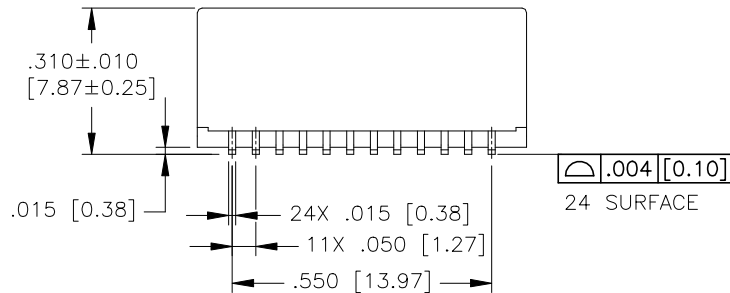

DIMENSIONS ARE IN INCHES [MILLIMETERS] WITH THE FOLLOWING TOLERANCES: [MILLIMETERS] ARE FOR REFERENCE ONLY.
.XX = ±.01 [±0.25]
.XXX = ±.005 [±0.13]

© Copyright, 2023. Pulse Electronics Corp. All rights reserved. Pulse confidential & proprietary. (01/04/23)

PRODUCT DESCRIPTION	TLA DRAWING	PS DRAWING	SHEET	PART NO.	DATASHEET REV.
MDL,SIN,HDBT,1:1,SM,TU	HD8006FNL-11	PS-2790.001-D	3 OF 4	HD8006FNL	C



CHANGE RECORD

REV	DESCRIPTION	DATE	APPROVED
B	-	05MAR18	BEZHOU
C	RELAX THE HEIGHT TOLERANCE TO ± 0.10 [± 0.25]	04JAN23	RICKWANG

© Copyright, 2023. Pulse Electronics Corp. All rights reserved. Pulse confidential & proprietary. (01/04/23)

PRODUCT DESCRIPTION	TLA DRAWING	PS DRAWING	SHEET	PART NO.	DATASHEET REV.
MDL,SIN,HDBT,1:1,SM,TU	HD8006FNL-11	PS-2790.001-D	4 OF 4	HD8006FNL	C