

SMD Wire Wound Ceramic Chip Inductors

BWHC Series



Due to accurate wire winding technology, these chip inductors are designed for filtering, impedance matching, resonance and choke circuits for RF designer. Both standard series custom designs are available.

Features

- RoHS compliant
- Ceramic body and wire wound construction provide highest SRFs
- Exceptional Q values even at high frequencies
- Highest possible SRFs as well as excellent Q values
- The non-magnetic coil form assures utmost thermal stability, predictability and batch consistency
- The high current rating and low loss to fit the RF applications

Applications

- RF products for cellular phone
- GPS receiver
- Base Station
- Repeater
- Wireless LAN/ mouse/ keyboard/ earphone
- Remote control
- Security system and other RF modules

Product Identification

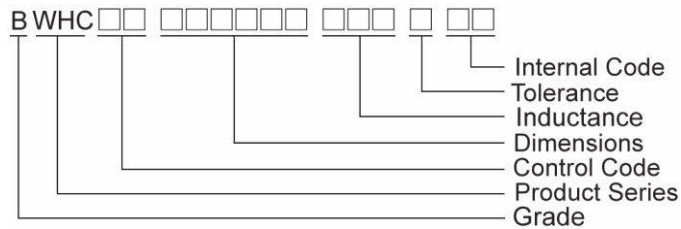

Shape and Dimensions/ Recommended Pattern

BWHC00181210

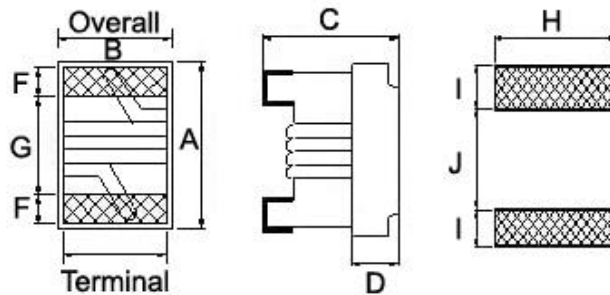

Dimensions

		A Max	B Max	C Max	D	E	F	G	H	I	J
BWHC00181210	inch	0.071	0.049	0.04	0.015	0.030	0.013	0.034	0.040	0.025	0.025
	mm	1.80	1.25	1.02	0.38	0.76	0.33	0.86	1.02	0.64	0.64

Electrical Characteristics

Part Number	Inductance (nH)	Tolerance (±%)	Test Frequency (MHz)	Q Min	Test Frequency (MHz)	SRF (MHz) Min	RDC (Ω) Max	I _{rms} (mA) Max	Color
BWHC001812101N6□00	1.6	10 / 5	250	24	250	12500	0.030	2400	Black
BWHC001812103N6□00	3.6	10 / 5	250	24	250	5900	0.048	2300	Brown
BWHC001812103N9□00	3.9	10 / 5	250	25	250	5900	0.054	2200	Red
BWHC001812104N3□00	4.3	10 / 5	250	25	250	5800	0.054	2100	Orange
BWHC001812106N8□00	6.8	10 / 5	250	35	250	5800	0.054	2100	Orange
BWHC001812107N5□00	7.5	10 / 5	250	35	250	3700	0.059	2100	Yellow
BWHC001812108N2□00	8.2	10 / 5	250	38	250	3700	0.071	2000	Brown
BWHC0018121010N□00	10	10 / 5	250	38	250	3700	0.071	2000	Green
BWHC0018121012N□00	12	10 / 5 / 2	250	38	250	3000	0.075	2000	Blue
BWHC0018121015N□00	15	10 / 5 / 2	250	38	250	2800	0.080	1900	Violet
BWHC0018121018N□00	18	10 / 5 / 2	250	40	250	2800	0.099	1900	Gray
BWHC0018121022N□00	22	10 / 5 / 2	250	42	250	2400	0.099	1800	White
BWHC0018121024N□00	24	10 / 5 / 2	250	42	250	2400	0.105	1800	Black

Note: When ordering, please specify tolerance code. Tolerance : G=±2% , J=±5% , K=±10%

- Operating temperature range - 40°C ~ 125°C(Including self - temperature rise)
- I_{rms} for a 20°C temperature rise from 25°C ambient with current
- Measure Equipment :
 L & Q : Agilent E4991A+Agilent HP16197A
 SRF : Agilent HP8753D
 RDC : HP4338B or Chroma 16502
 I_{rms} : HP4284A+HP42841A/HP4285A+HP42841A

Test Instruments : Agilent E4991A Material/Impedance Analyzer

Typical L vs. Frequency

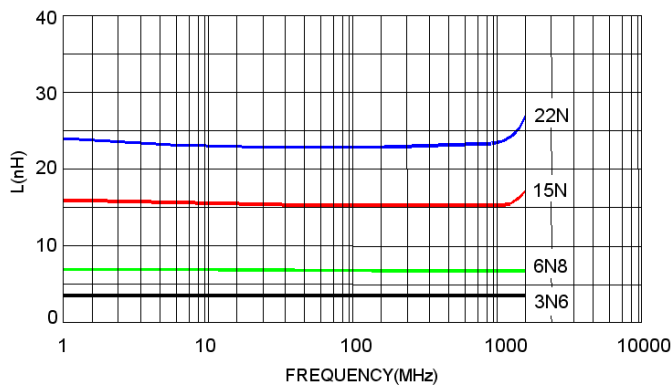

Typical Q vs. Frequency

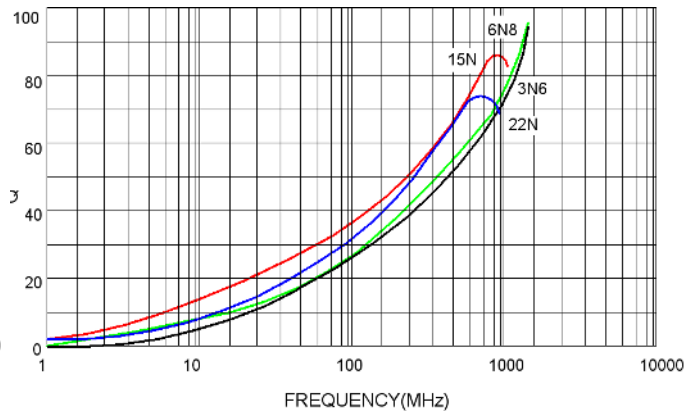

Packaging Specifications

Tape Dimensions

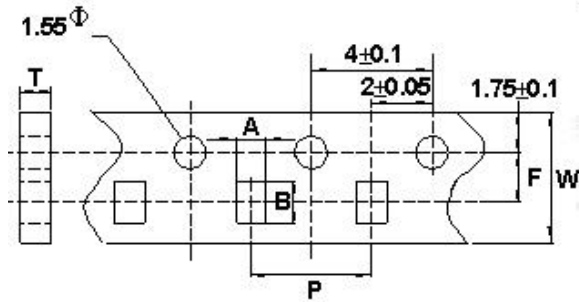

Tape Material

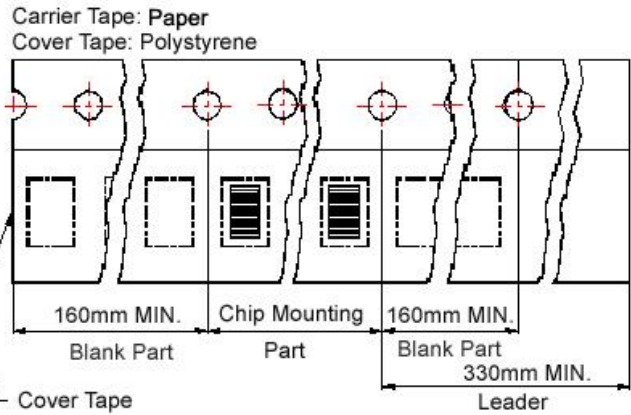

Reel Dimensions

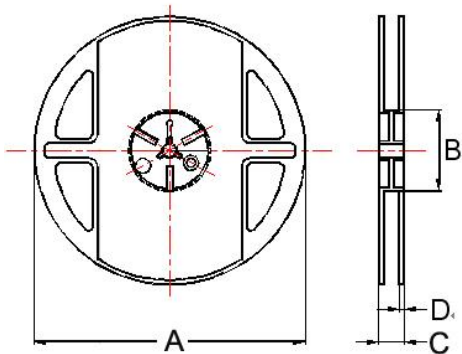

Dimensions in mm

TYPE	Tape Dimensions						Reel Dimensions				Quantity PCS / REEL
	A	B	T	W	P	F	A	B	C	D	
BWHC00181210	1.25	1.90	1.05	8	4	3.5	178	60	12	1.5	4000

For More Information:

Americas - prodinfo_power_americas@yageo.com | Europe - prodinfo_power_emea@yageo.com | Asia - prodinfo_power_asia@yageo.com

Performance warranty of products offered on this data sheet is limited to the parameters specified. Data is subject to change without notice. Other brand and product names mentioned herein may be trademarks or registered trademarks of their respective owners. © Copyright, 2022. Pulse Electronics, Inc. All rights reserved.