

## ASM3-SxDx-xxxxH

### 3W 3535 Surface Mount LED



### Description

The Broadcom<sup>®</sup> 3535 surface mount LEDs are energy-efficient LEDs that can be driven at high driving current and able to dissipate heat efficiently resulting in a better performance in reliability. Its low profile package design addresses a wide variety of applications where superior robustness and high efficiency are required. In addition to being compatible to the reflow soldering process, the silicone encapsulation ensures product superiority and longevity.

To facilitate easy pick-and-place assembly, the LEDs are packed in tape and reel. Every reel is shipped in single flux and color bin, to provide close uniformity.

### Features

- High reliability package with enhanced silicone resin encapsulation
- Available in Deep Red, Far Red, Royal Blue, and Cool White
- Wide viewing angle at 130°
- Compatible with the reflow soldering process
- JEDEC MSL3

### Applications

- Horticulture lighting
- General lighting
- Commercial lighting
- Architecture lighting

**CAUTION!** This LED is ESD sensitive. Observe appropriate precautions during handling and processing. Refer to application note AN-1142 for additional details.

Figure 1: Package Drawing

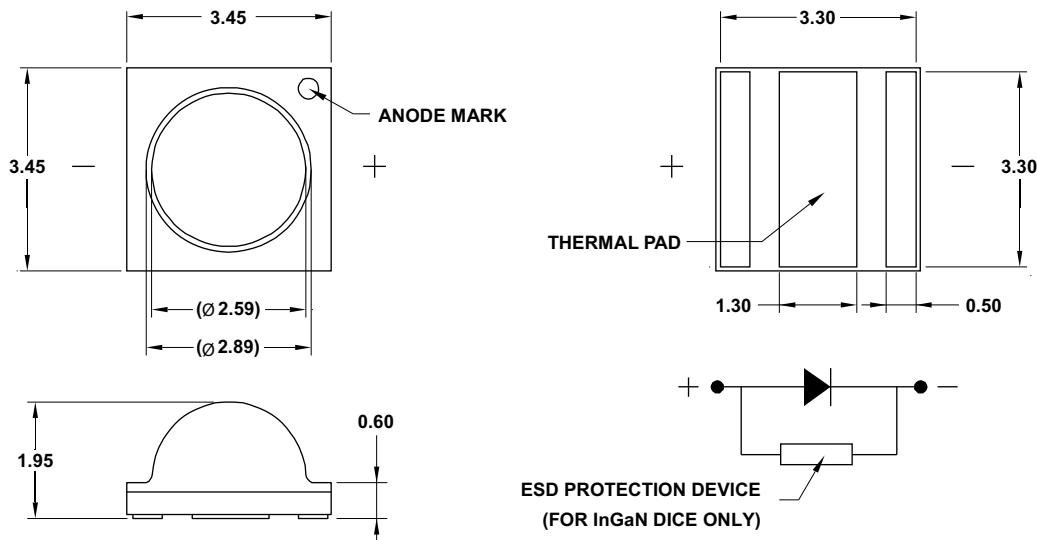

**NOTE:**

1. All dimensions in millimeters (mm).
2. Tolerance is  $\pm 0.20$  mm unless otherwise specified.
3. Encapsulation = silicone.
4. Terminal finish = silver plating.
5. Dimensions in bracket are for reference only.

**Device Selection Guide ( $T_J = 25^\circ\text{C}$ ,  $I_F = 350$  mA)**

Part Number	Color	Viewing Angle, $2\theta_{1/2}^a$	Radiant Flux, $\Phi_e$ (mW) <sup>b, c</sup>			PPF, $\Phi_P$ ( $\mu\text{mol}/\text{J}$ ) <sup>d, e</sup>	PPF/W ( $\mu\text{mol}/\text{J}$ )	Dice Technology
		Typ.	Min.	Typ.	Max.	Typ.	Typ.	
ASM3-S3D0-ALN0H	Far Red	130	230	285	380	1.76 <sup>f</sup>	2.39	AllInGaP
ASM3-SDD0-ANP0H	Deep Red	130	330	350	430	1.93	2.63	AllInGaP
ASM3-SDD0-APQ0H	Deep Red	130	380	390	480	2.13	2.90	AllInGaP
ASM3-SLD1-NST0H	Royal Blue	130	530	580	705	2.19	2.09	InGaN
ASM3-SWD1-NPRHH	Cool White	130	115	125	154	1.75	1.67	InGaN

- a.  $\theta_{1/2}$  is the off-axis angle where the luminous intensity is half of the peak intensity.
- b. Radiant flux,  $\Phi_e$  / Luminous flux,  $\Phi_v$  is the total output measured with an integrating sphere at a single current pulse condition.
- c. Radiant flux,  $\Phi_e$  / Luminous flux,  $\Phi_v$  tolerance is  $\pm 10\%$ .
- d. Photosynthetic Photon Flux (PPF),  $\Phi_P$  is the measurement of Photosynthetically Active Radiation (PAR) ranging from 400 nm to 700 nm.
- e. Values are calculated and for reference only.
- f. Plant Biologically Active Radiation Flux (PBAR) for Far Red is measured from 280 nm to 800 nm.

## Absolute Maximum Ratings

Parameters	InGaN	AlInGaP	Unit
DC Forward Current <sup>a</sup>	700	700	mA
Peak Forward Current <sup>b</sup>	1000	1000	mA
Power Dissipation	2800	1925	mW
Reverse Voltage	Not designed for reverse bias operation		
LED Junction Temperature	120	120	°C
Operating Temperature Range	-40 to +85	-40 to +85	°C
Storage Temperature Range	-40 to +100	-40 to +100	°C

a. Derate linearly as shown in [Figure 15](#), [Figure 16](#), and [Figure 17](#).

b. Duty factor = 10%, frequency = 1 kHz.

## Optical and Electrical Characteristics (T<sub>J</sub> = 25°C, I<sub>F</sub> = 350 mA)

Color	Peak Wavelength, λ <sub>p</sub> (nm)			Forward Voltage, V <sub>F</sub> (V) <sup>a</sup>			Thermal Resistance, R <sub>θJ-S</sub> (°C/W) <sup>b</sup>
	Min.	Typ.	Max.	Min.	Typ.	Max.	Typ.
Far Red	720	735	745	1.75	2.10	2.75	15
Deep Red	650	655	670	1.75	2.10	2.75	8
Royal Blue	440	450	460	2.75	3.00	4.00	8

a. Forward voltage, V<sub>F</sub> tolerance is ±0.1V.

b. Thermal resistance from LED junction to solder point.

Color	Correlated Color Temperature, CCT (Kelvin)		Color Rendering Index, CRI	Forward Voltage, V <sub>F</sub> (V) <sup>a</sup>			Thermal Resistance, R <sub>θJ-S</sub> (°C/W) <sup>b</sup>
	Min.	Max.	Min.	Min.	Typ.	Max.	Typ.
Cool White	5000K	10000K	70	2.75	3.00	4.00	15

a. Forward voltage, V<sub>F</sub> tolerance is ±0.1V.

b. Thermal resistance from LED junction to solder point.

## Part Numbering System

A S M 3 - S 

x <sub>1</sub>	x <sub>2</sub>	x <sub>3</sub>
----------------	----------------	----------------

 - 

x <sub>4</sub>	x <sub>5</sub>	x <sub>6</sub>	x <sub>7</sub>	x <sub>8</sub>
----------------	----------------	----------------	----------------	----------------

Code	Description	Option	
x <sub>1</sub>	Color	3	Far Red
		D	Deep Red
		L	Royal Blue
		W	Cool White
x <sub>2</sub>	Viewing Angle	D	130°
x <sub>3</sub>	ESD Protection	0	Without Zener Protection (for AlInGaP dice only)
		1	With Zener Protection (for InGaN dice only)
x <sub>4</sub>	Dice Technology	A	AlInGaP
		N	InGaN
x <sub>5</sub>	Minimum Flux Bin	Refer to Radiant Flux/Luminous Flux Bin Limits (CAT) table	
x <sub>6</sub>	Maximum Flux Bin		
x <sub>7</sub>	Color Bin Option – Far Red, Deep Red, and Royal Blue	0	Full Distribution
		C	3 and 4 only
		D	4 and 5 only
		E	5 and 6 only
		J	3, 4, and 5 only
	K	4, 5, and 6 only	
	Color Bin Option - Cool White	H	6500K
x <sub>8</sub>	Test Option	H	Test Current = 350 mA

## Part Number Example

ASM3-S3D0-ALN0H

- x<sub>1</sub>: 3 – Far Red color
- x<sub>2</sub>: D – 130° viewing angle
- x<sub>3</sub>: 0 – Without Zener Protection (for AlInGaP dice only)
- x<sub>4</sub>: A – AlInGaP dice
- x<sub>5</sub>: L – Minimum radiant flux bin L
- x<sub>6</sub>: N – Maximum radiant flux bin N
- x<sub>7</sub>: 0 – Full color distribution
- x<sub>8</sub>: H – Test current = 350 mA

# Bin Information

## Luminous Flux Bin Limits (CAT)

Bin ID	Luminous Flux, $\Phi_V$ (lm)	
	Min.	Max.
<b>Cool White</b>		
P	115.0	127.0
Q	127.0	140.0
R	140.0	154.0

Tolerance =  $\pm 12\%$

## Radiant Flux Bin Limits (CAT)

Bin ID	Radiant Flux, $\Phi_e$ (mW)	
	Min.	Max.
<b>Far Red, Deep Red and Royal Blue</b>		
L	230	280
M	280	330
N	330	380
P	380	430
Q	430	480
R	480	530
S	530	610
T	610	705

Tolerance =  $\pm 12\%$

## Color Bin Limits (BIN)

Bin ID	Peak Wavelength, $\lambda_p$ (nm)	
	Min.	Max.
<b>Royal Blue</b>		
3	440	445
4	445	450
5	450	455
6	455	460
<b>Deep Red</b>		
—	650	670
<b>Far Red</b>		
—	720	745

Tolerance =  $\pm 1.0\text{nm}$

## Color Bin Limits (BIN) – Cool White

Bin ID	Chromaticity Coordinates		Bin ID	Chromaticity Coordinates		Bin ID	Chromaticity Coordinates	
	x	y		x	y		x	y
1A	0.2950	0.2970	2A	0.3048	0.3207	3A	0.3215	0.3350
	0.2920	0.3060		0.3130	0.3290		0.3290	0.3417
	0.2984	0.3133		0.3144	0.3186		0.3290	0.3300
	0.3009	0.3042		0.3068	0.3113		0.3222	0.3243
1B	0.2920	0.3060	2B	0.3028	0.3304	3B	0.3207	0.3462
	0.2895	0.3135		0.3115	0.3391		0.3290	0.3538
	0.2962	0.3220		0.3130	0.3290		0.3290	0.3417
	0.2984	0.3133		0.3048	0.3207		0.3215	0.3350
1C	0.2984	0.3133	2C	0.3115	0.3391	3C	0.3290	0.3538
	0.2962	0.3220		0.3205	0.3481		0.3376	0.3616
	0.3028	0.3304		0.3213	0.3373		0.3371	0.3490
	0.3048	0.3207		0.3130	0.3290		0.3290	0.3417
1D	0.2984	0.3133	2D	0.3130	0.3290	3D	0.3290	0.3417
	0.3048	0.3207		0.3213	0.3373		0.3371	0.3490
	0.3068	0.3113		0.3221	0.3261		0.3366	0.3369
	0.3009	0.3042		0.3144	0.3186		0.3290	0.3300
1E	0.2895	0.3135	2E	0.3005	0.3415	3E	0.3196	0.3602
	0.2870	0.3210		0.3099	0.3509		0.3290	0.3690
	0.2937	0.3312		0.3115	0.3391		0.3290	0.3538
	0.2962	0.3220		0.3028	0.3304		0.3207	0.3462
1F	0.2962	0.3220	2F	0.3099	0.3509	3F	0.3290	0.3690
	0.2937	0.3312		0.3196	0.3602		0.3381	0.3762
	0.3005	0.3415		0.3205	0.3481		0.3376	0.3616
	0.3028	0.3304		0.3115	0.3391		0.3290	0.3538
1G	0.2980	0.2880	2G	0.3068	0.3113	3G	0.3222	0.3243
	0.2950	0.2970		0.3144	0.3186		0.3290	0.3300
	0.3009	0.3042		0.3161	0.3059		0.3290	0.3180
	0.3037	0.2937		0.3093	0.2993		0.3231	0.3120
1H	0.3037	0.2937	2H	0.3144	0.3186	3H	0.3290	0.3300
	0.3009	0.3042		0.3221	0.3261		0.3366	0.3369
	0.3068	0.3113		0.3231	0.3120		0.3361	0.3245
	0.3093	0.2993		0.3161	0.3059		0.3290	0.3180

Tolerance =  $\pm 0.01$

### Example of bin information on reel and packaging label:

CAT: P – Radiant flux bin P  
 BIN: — – Full distribution

Figure 2: Chromaticity Diagram

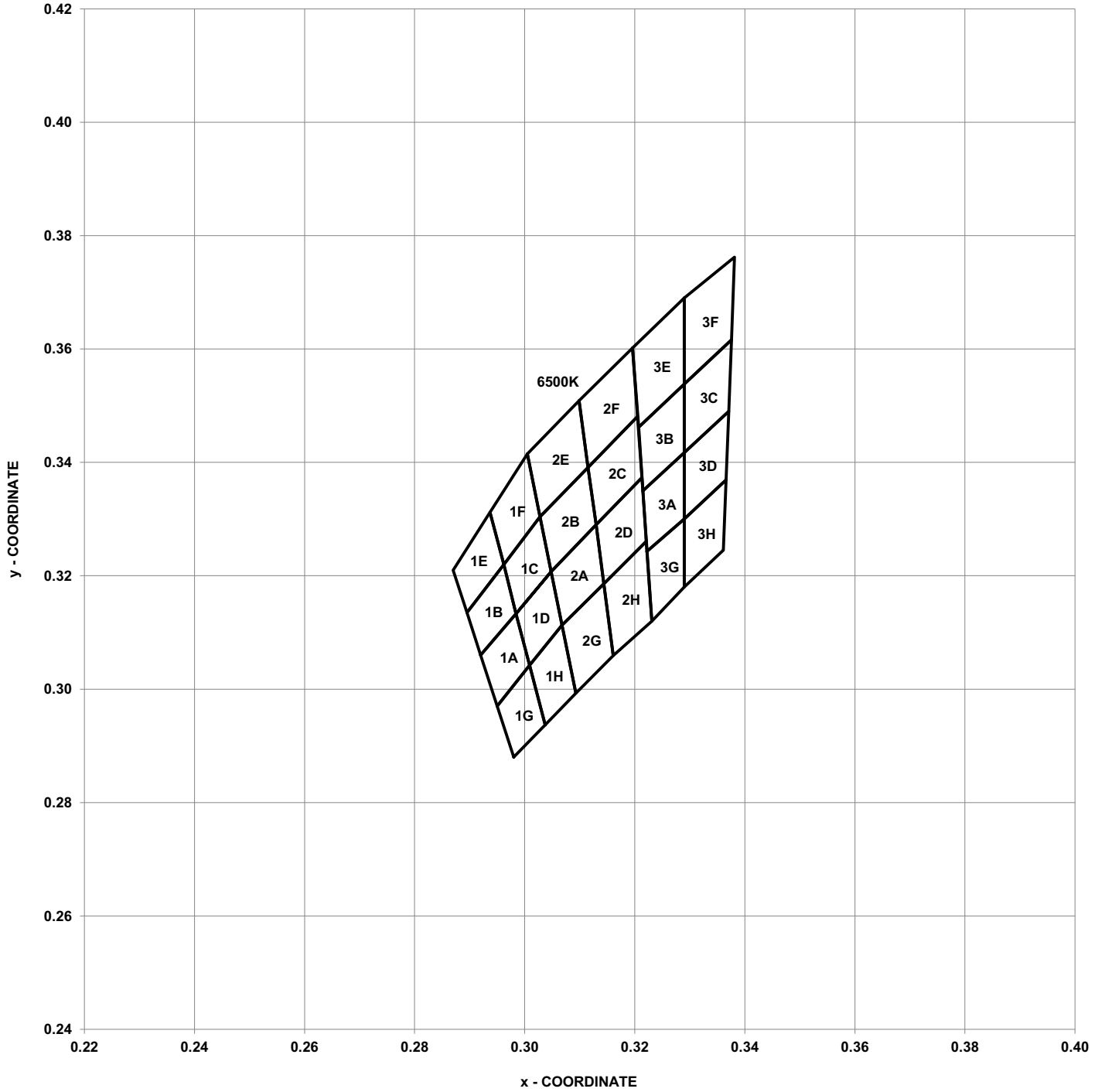

Figure 3: Spectral Power Distribution for Cool White

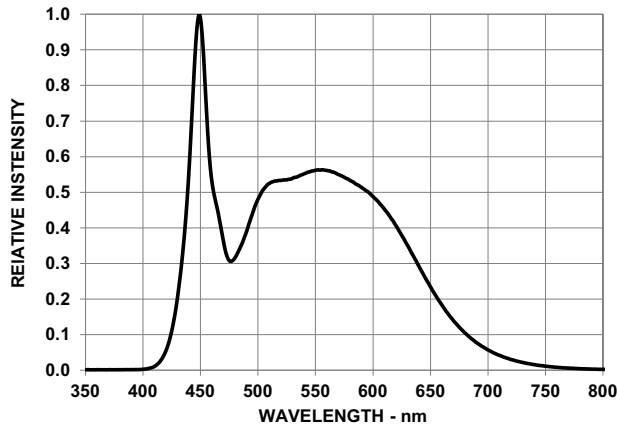

Figure 4: Spectral Power Distribution for Far Red, Deep Red, and Royal Blue

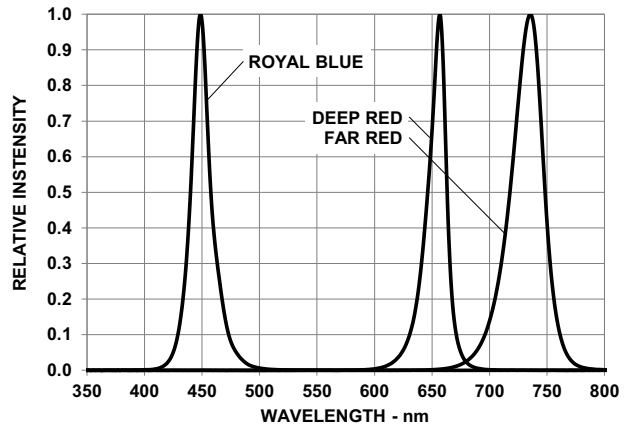

Figure 5: Relative Luminous Flux vs. Mono Pulse Current for Cool White

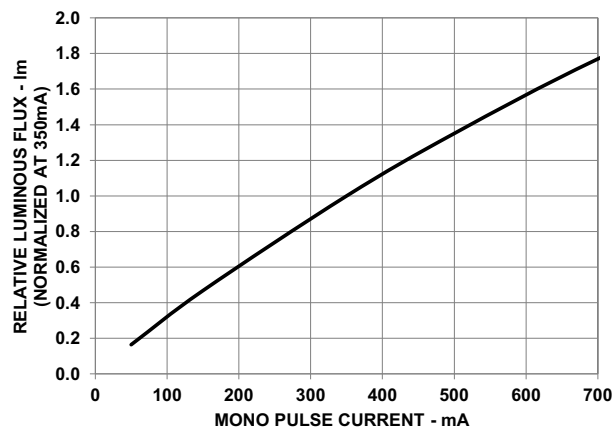

Figure 6: Relative Radiant Flux vs. Mono Pulse Current for Far Red, Deep Red, and Royal Blue

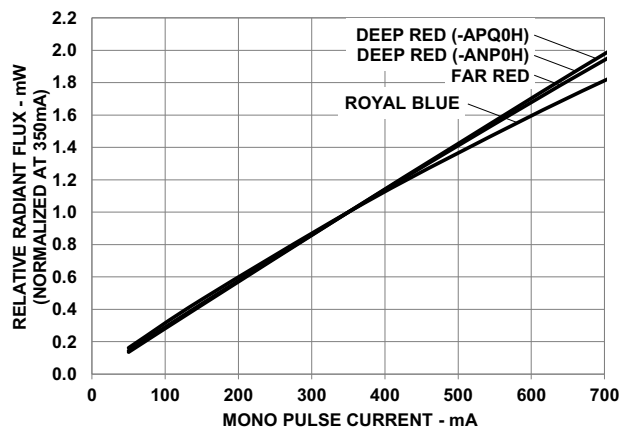

Figure 7: Forward Current vs. Forward Voltage

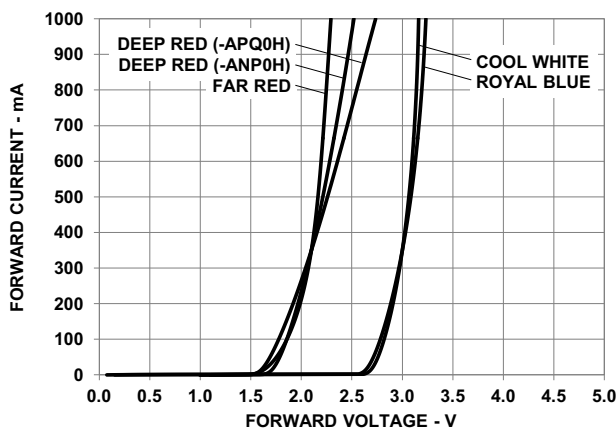
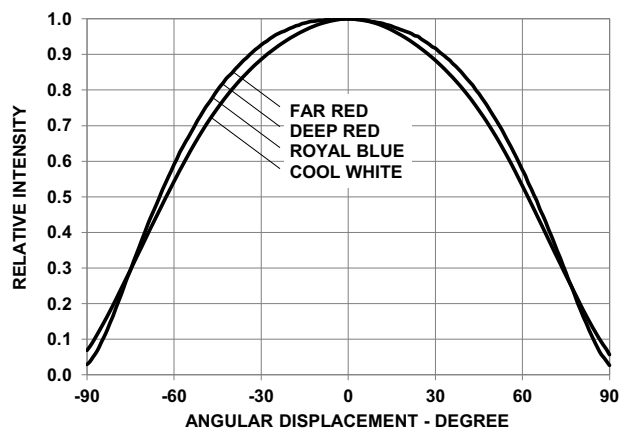
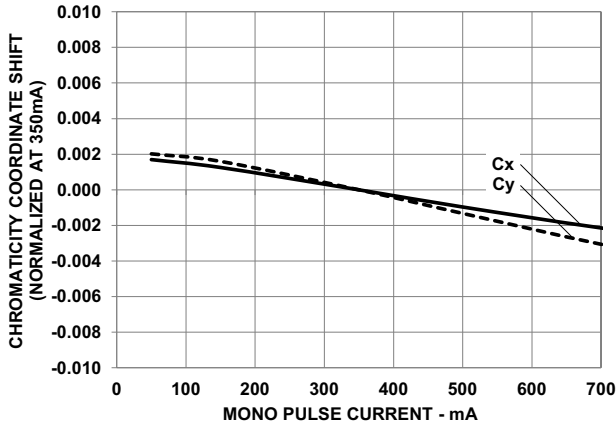

Figure 8: Radiation Pattern

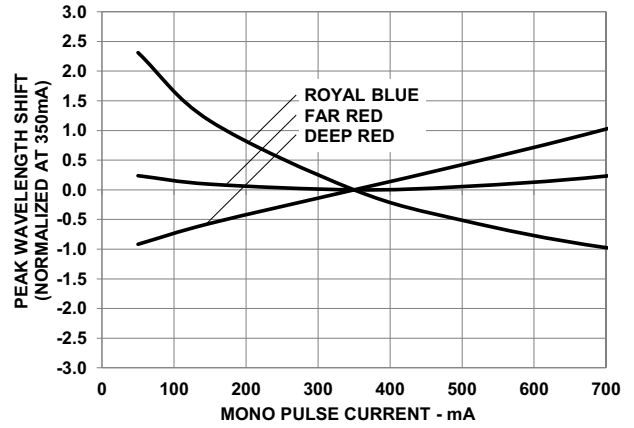



**Figure 9: Chromaticity Coordinate Shift vs. Mono Pulse Current for Cool White**



**Figure 10: Peak Wavelength Shift vs. Mono Pulse Current for Far Red, Deep Red, and Royal Blue**



**Figure 11: Relative Light Output vs. Junction Temperature**

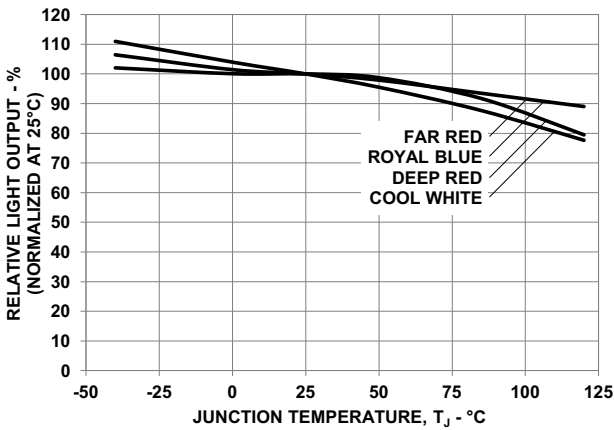

**Figure 12: Forward Voltage Shift vs. Junction Temperature**

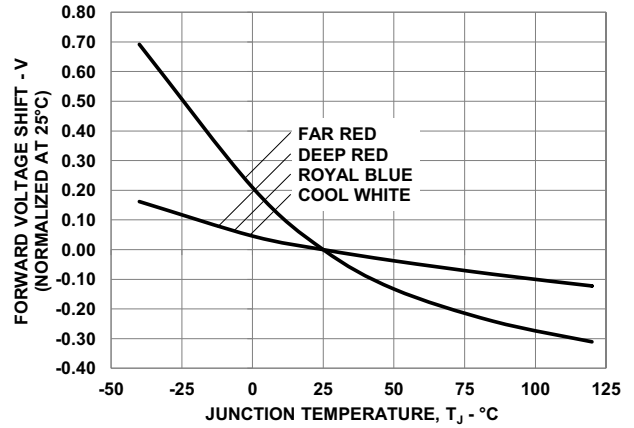

**Figure 13: Chromaticity Coordinate Shift vs. Junction Temperature**

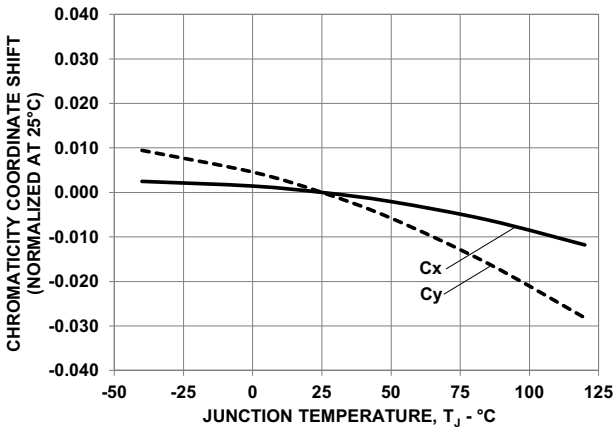

**Figure 14: Peak Wavelength Shift vs. Junction Temperature**

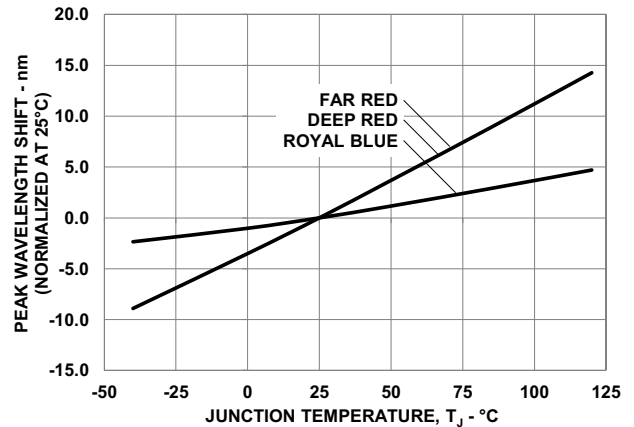

Figure 15: Maximum Forward Current vs. Ambient Temperature for InGaN

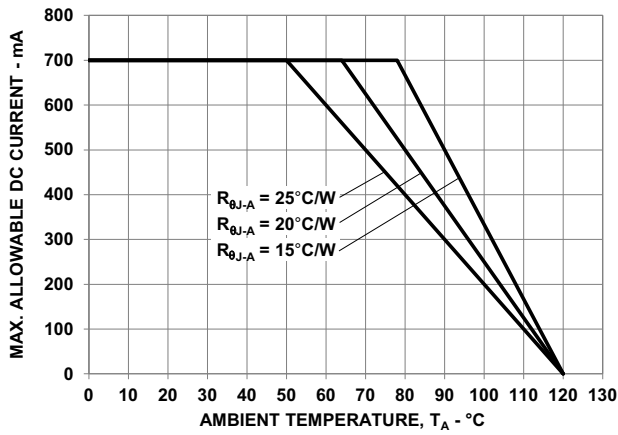

Figure 16: Maximum Forward Current vs. Ambient Temperature for AlInGaP

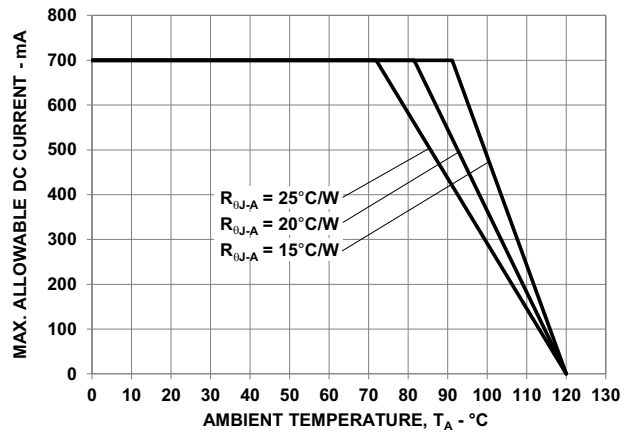

Figure 17: Maximum Forward Current vs. Solder Point Temperature

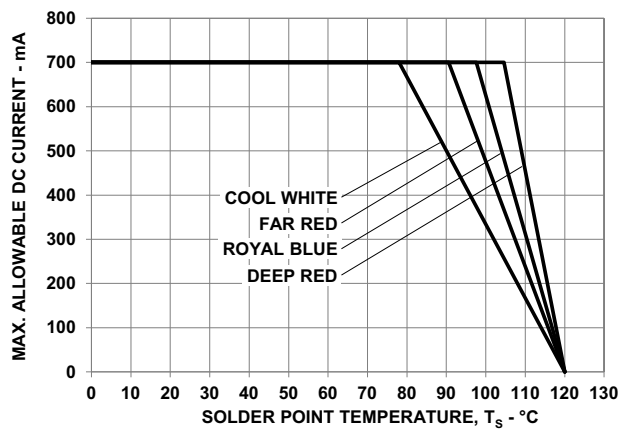

Figure 18: Recommended Soldering Land Pattern

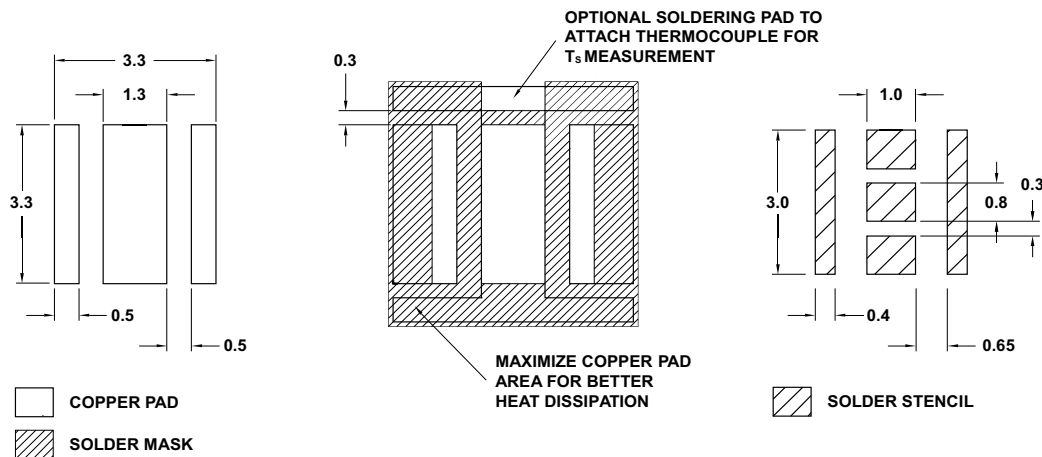
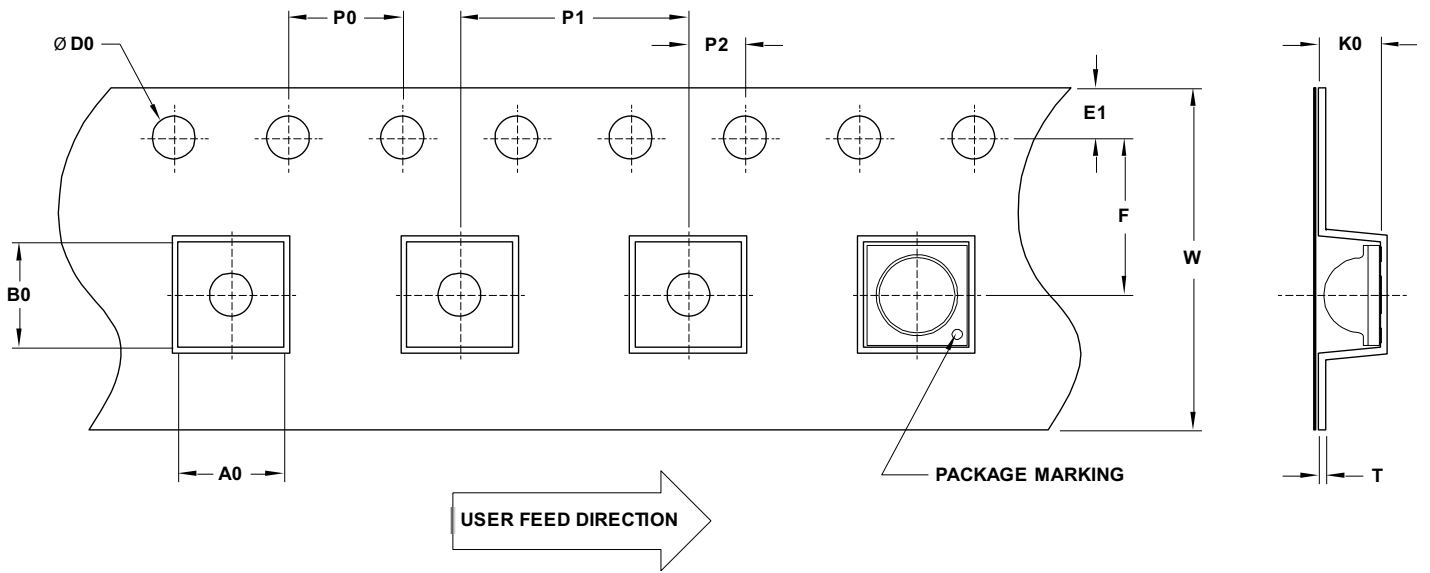

Figure 19: Carrier Tape Dimensions



F	P0	P1	P2	D0	E1	W
5.50 ± 0.05	4.00 ± 0.10	8.00 ± 0.10	2.00 ± 0.05	1.50 + 0.1	1.75 ± 0.10	12.00 ± 0.20

T	B0	K0	A0
0.25 ± 0.05	3.70 ± 0.10	2.15 ± 0.10	3.70 ± 0.10

**NOTE:** All dimensions are in millimeters (mm).

Figure 20: Reel Dimensions

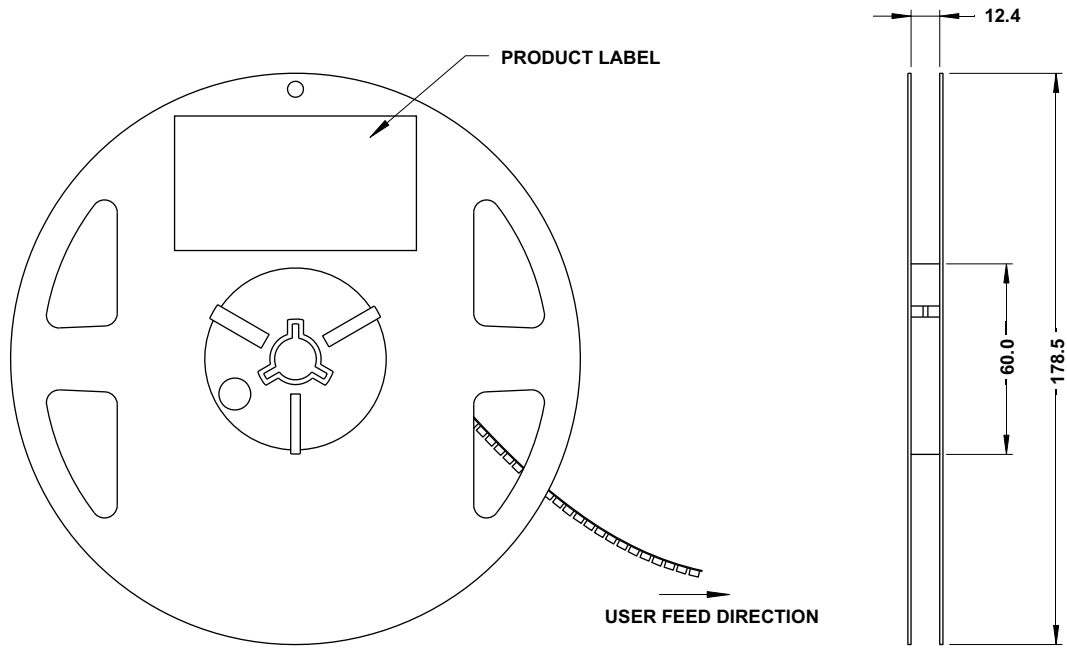

**NOTE:** All dimensions are in millimeters (mm).

## Precautionary Notes

### Soldering

- Do not perform reflow soldering more than twice. Observe necessary precautions of handling moisture-sensitive devices as stated in the following section.
- Do not apply any pressure or force on the LED during reflow and after reflow when the LED is still hot.
- Use reflow soldering to solder the LED. Use hand soldering only for rework if unavoidable, but it must be strictly controlled to following conditions:
  - Soldering iron tip temperature = 315°C maximum
  - Soldering duration = 3sec maximum
  - Number of cycles = 1 only
  - Power of soldering iron = 50W maximum
- Do not touch the LED package body with the soldering iron except for the soldering terminals, because it may cause damage to the LED.
- Confirm beforehand whether the functionality and performance of the LED is affected by soldering with hand soldering.

- Do not poke sharp objects into the silicone encapsulant. Sharp objects, such as tweezers or syringes, might apply excessive force or even pierce through the silicone and induce failures to the LED die or wire bond.
- Do not touch the silicone encapsulant. Uncontrolled force acting on the silicone encapsulant might result in excessive stress on the wire bond. Hold the LED only by the body.
- Do not stack assembled PCBs together. Use an appropriate rack to hold the PCBs.
- Surface of silicone material attracts dust and dirt easier than epoxy due to its surface tackiness. To remove foreign particles on the surface of silicone, use a cotton bud with isopropyl alcohol (IPA). During cleaning, rub the surface gently without putting too much pressure on the silicone. Ultrasonic cleaning is not recommended.
- For automated pick and place, Broadcom has tested a nozzle size with OD 3.5 mm to work with this LED. However, due to the possibility of variations in other parameters such as pick-and-place machine maker/model, and other settings of the machine, verify that the selected nozzle will not cause damage to the LED.

Figure 21: Recommended Lead-Free Reflow Soldering Profile

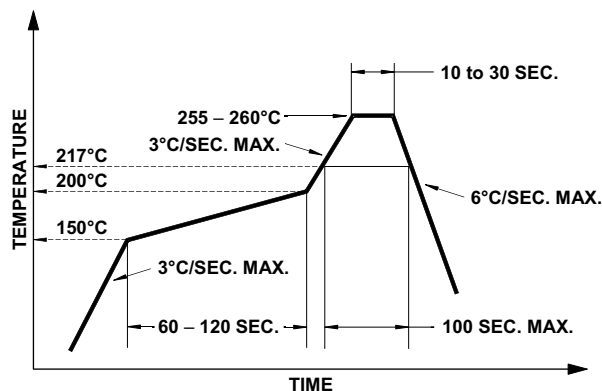

### Handling Precautions

The encapsulation material of the LED is made of silicone for better product reliability. Compared to epoxy encapsulant, which is hard and brittle, silicone is softer and flexible. Observe special handling precautions during assembly of silicone encapsulated LED products. Failure to comply might lead to damage and premature failure of the LED. Refer to Broadcom Application Note AN5288, *Silicone Encapsulation for LED: Advantages and Handling Precautions*, for additional information.

### Handling of Moisture-Sensitive Devices

This product has a Moisture Sensitive Level 3 rating per JEDEC J-STD-020. Refer to Broadcom Application Note AN5305, *Handling of Moisture Sensitive Surface Mount Devices* for additional details and a review of proper handling procedures.

- Before use:
  - An unopened moisture barrier bag (MBB) can be stored at <40°C/90% RH for 12 months. If the actual shelf life has exceeded 12 months and the Humidity Indicator Card (HIC) indicates that baking is not required, it is safe to reflow the LEDs per the original MSL rating.
  - Do not open the MBB prior to assembly (for example, for IQC). If unavoidable, MBB must be properly resealed with fresh desiccant and HIC. The exposed duration must be taken in as floor life.
- Control after opening the MBB:
  - Read the HIC immediately upon opening of MBB.
  - Keep the LEDs at <30°/60% RH at all times, and complete all high temperature-related processes, including soldering, curing or rework within 168 hours.

- Control for unfinished reel:  
Store unused LEDs in a sealed MBB with desiccant or a desiccator at <5% RH.

#### Control of assembled boards:

If the PCB soldered with the LEDs is to be subjected to other high-temperature processes, store the PCB in a sealed MBB with desiccant or desiccator at <5% RH to ensure that all LEDs have not exceeded their floor life of 168 hours.

- Baking is required if:
  - The HIC indicator indicates a change in color for 10% and 5%, as stated on the HIC.
  - The LEDs are exposed to conditions of >30°C/60% RH at any time.
  - The LED's floor life exceeded 168 hours.

The recommended baking condition is: 60°C ± 5°C for 20 hours.

Baking can only be done once.

- Storage:  
The soldering terminals of these Broadcom LEDs are silver plated. If the LEDs are exposed in ambient environment for too long, the silver plating might be oxidized, thus affecting its solderability performance. As such, keep unused LEDs in a sealed MBB with desiccant or in a desiccator at <5% RH.

## Application Precautions

- The drive current of the LED must not exceed the maximum allowable limit across temperature as stated in the data sheet. Constant current driving is recommended to ensure consistent performance.
- Circuit design must cater to the whole range of forward voltage ( $V_F$ ) of the LEDs to ensure the intended drive current can always be achieved.
- The LED exhibits slightly different characteristics at different drive currents, which may result in a larger variation of performance (meaning: intensity, wavelength, and forward voltage). Set the application current as close as possible to the test current to minimize these variations.
- Do not use the LED in the vicinity of material with sulfur content or in environments of high gaseous sulfur compounds and corrosive elements. Examples of material that might contain sulfur are rubber gaskets, room-temperature vulcanizing (RTV) silicone rubber, rubber gloves, and so on. Prolonged exposure to such environments may affect the optical characteristics and product life.

- White LEDs must not be exposed to acidic environments and must not be used in the vicinity of any compound that may have acidic outgas, such as, but not limited to, acrylate adhesive. These environments have an adverse effect on LED performance.
- Avoid rapid change in ambient temperature, especially in high-humidity environments, because they cause condensation on the LED.
- If the LED is intended to be used in harsh or outdoor environments, protect the LED against damages caused by rain water, water, dust, oil, corrosive gases, external mechanical stresses, and so on.

## Thermal Management

The optical, electrical, and reliability characteristics of the LED are affected by temperature. Keep the junction temperature ( $T_J$ ) of the LED below the allowable limit at all times.  $T_J$  can be calculated as follows:

$$T_J = T_A + R_{\theta J-A} \times I_F \times V_{Fmax}$$

where:

$T_A$  = ambient temperature (°C)

$R_{\theta J-A}$  = thermal resistance from LED junction to ambient (°C/W)

$I_F$  = forward current (A)

$V_{Fmax}$  = maximum forward voltage (V)

The complication of using this formula lies in  $T_A$  and  $R_{\theta J-A}$ . Actual  $T_A$  is sometimes subjective and hard to determine.  $R_{\theta J-A}$  varies from system to system depending on design and is usually not known.

Another way of calculating  $T_J$  is by using the solder point temperature,  $T_S$  as follows:

$$T_J = T_S + R_{\theta J-S} \times I_F \times V_{Fmax}$$

where:

$T_S$  = LED solder point temperature as shown in the following figure (°C)

$R_{\theta J-S}$  = thermal resistance from junction to solder point (°C/W)

$I_F$  = forward current (A)

$V_{Fmax}$  = maximum forward voltage (V)

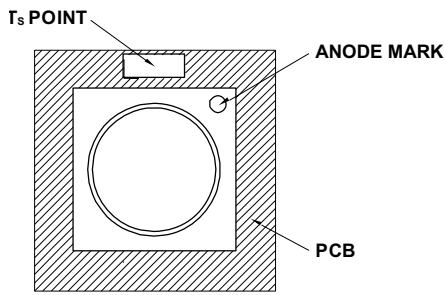
**Figure 22: Solder Point Temperature on PCB**

$T_S$  can be easily measured by mounting a thermocouple on the soldering joint as shown in preceding figure, while  $R_{\theta J-S}$  is provided in the data sheet. Verify the  $T_S$  of the LED in the final product to ensure that the LEDs are operating within all maximum ratings stated in the data sheet.

## Eye Safety Precautions

LEDs may pose optical hazards when in operation. Do not look directly at operating LEDs because it might be harmful to the eyes. For safety reasons, use appropriate shielding or personal protective equipment.

## Disclaimer

Broadcom's products and software are not specifically designed, manufactured, or authorized for sale as parts, components, or assemblies for the planning, construction, maintenance, or direct operation of a nuclear facility or for use in medical devices or applications. The customer is solely responsible, and waives all rights to make claims against Broadcom or its suppliers, for all loss, damage, expense, or liability in connection with such use.

Broadcom, the pulse logo, Connecting everything, Avago Technologies, Avago, and the A logo are among the trademarks of Broadcom and/or its affiliates in the United States, certain other countries, and/or the EU.

Copyright © 2019 Broadcom. All Rights Reserved.

The term "Broadcom" refers to Broadcom Inc. and/or its subsidiaries. For more information, please visit [www.broadcom.com](http://www.broadcom.com).

Broadcom reserves the right to make changes without further notice to any products or data herein to improve reliability, function, or design. Information furnished by Broadcom is believed to be accurate and reliable. However, Broadcom does not assume any liability arising out of the application or use of this information, nor the application or use of any product or circuit described herein, neither does it convey any license under its patent rights nor the rights of others.

