

PLUG P/N	CKT	DIM "A"	DIM "B"	DIM "C"	DIM "D"
1727673002	2	5.40	5.80	10.80	4.95
1727673004	4	9.60	10.00	15.00	4.95
1727673006	6	13.80	14.20	19.20	4.95
1727673008	8	18.00	18.40	23.40	4.95
1727673010	10	22.20	22.60	27.60	12.95
1727673012	12	26.40	26.80	31.80	12.95
1727673014	14	30.60	31.00	36.00	12.95
1727673016	16	34.80	35.20	40.20	12.95
1727673018	18	39.00	39.40	44.40	20.95

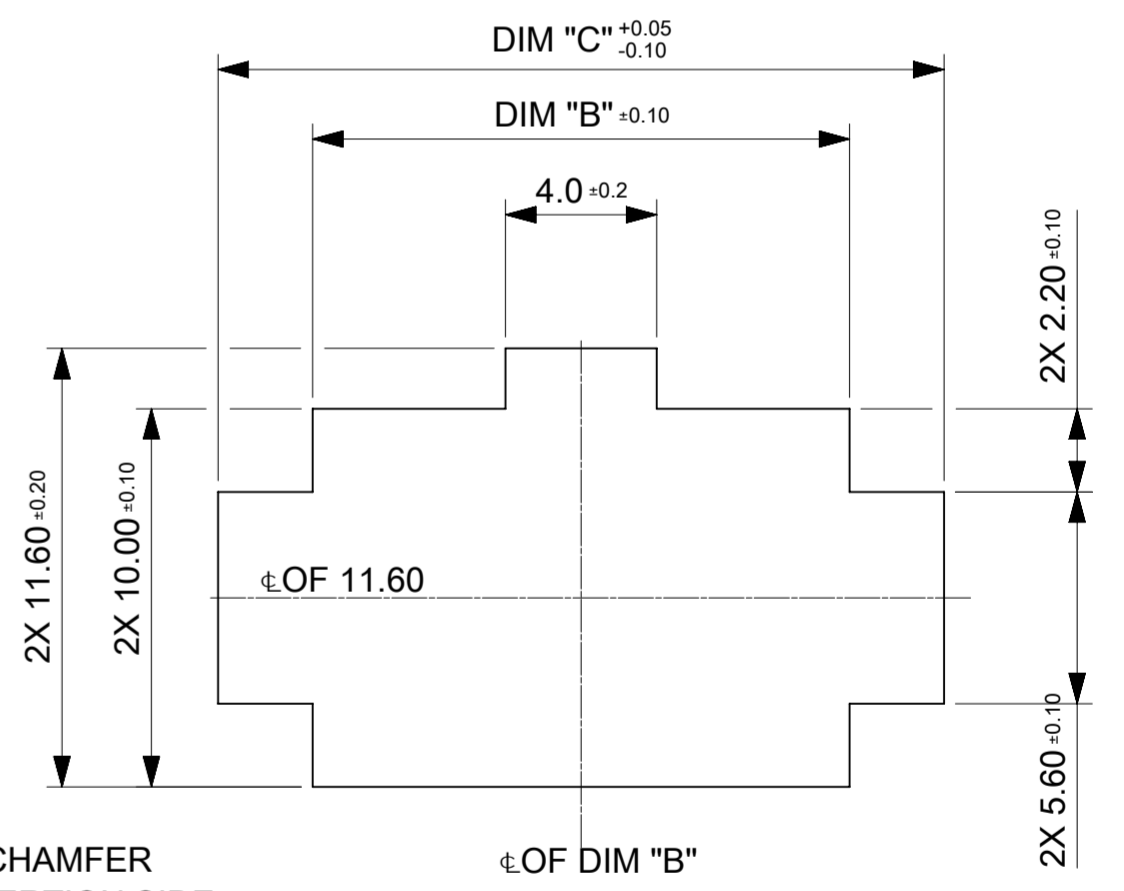
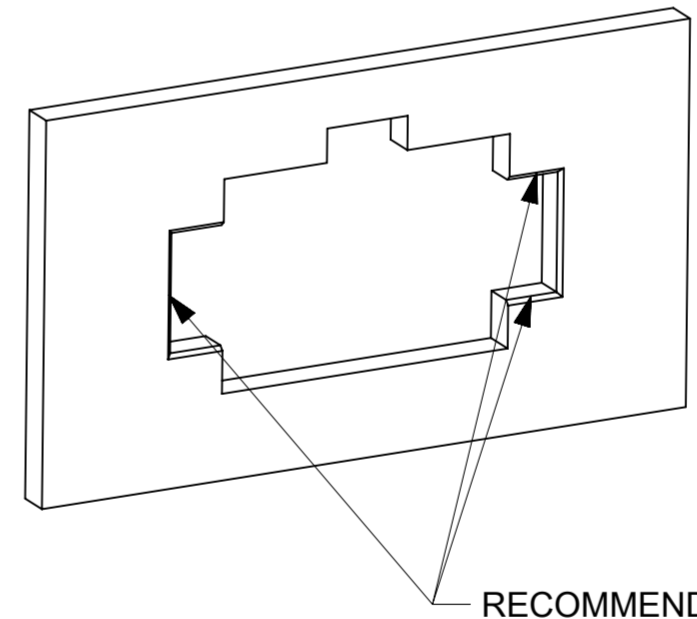
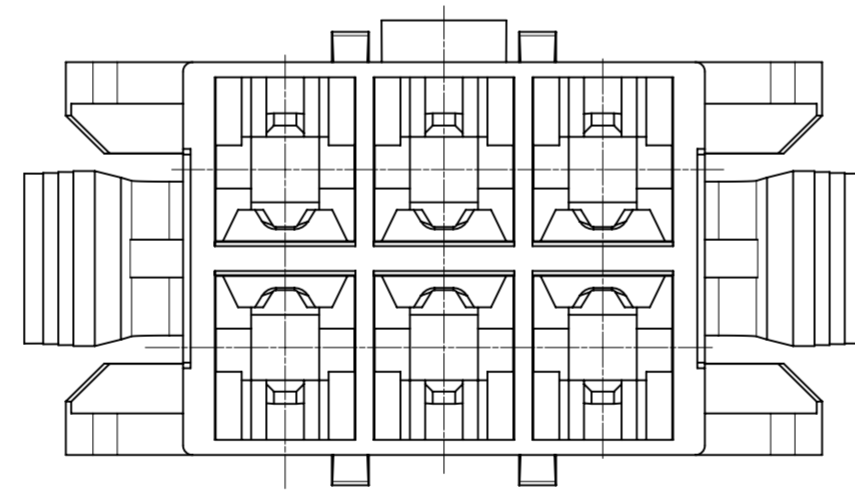
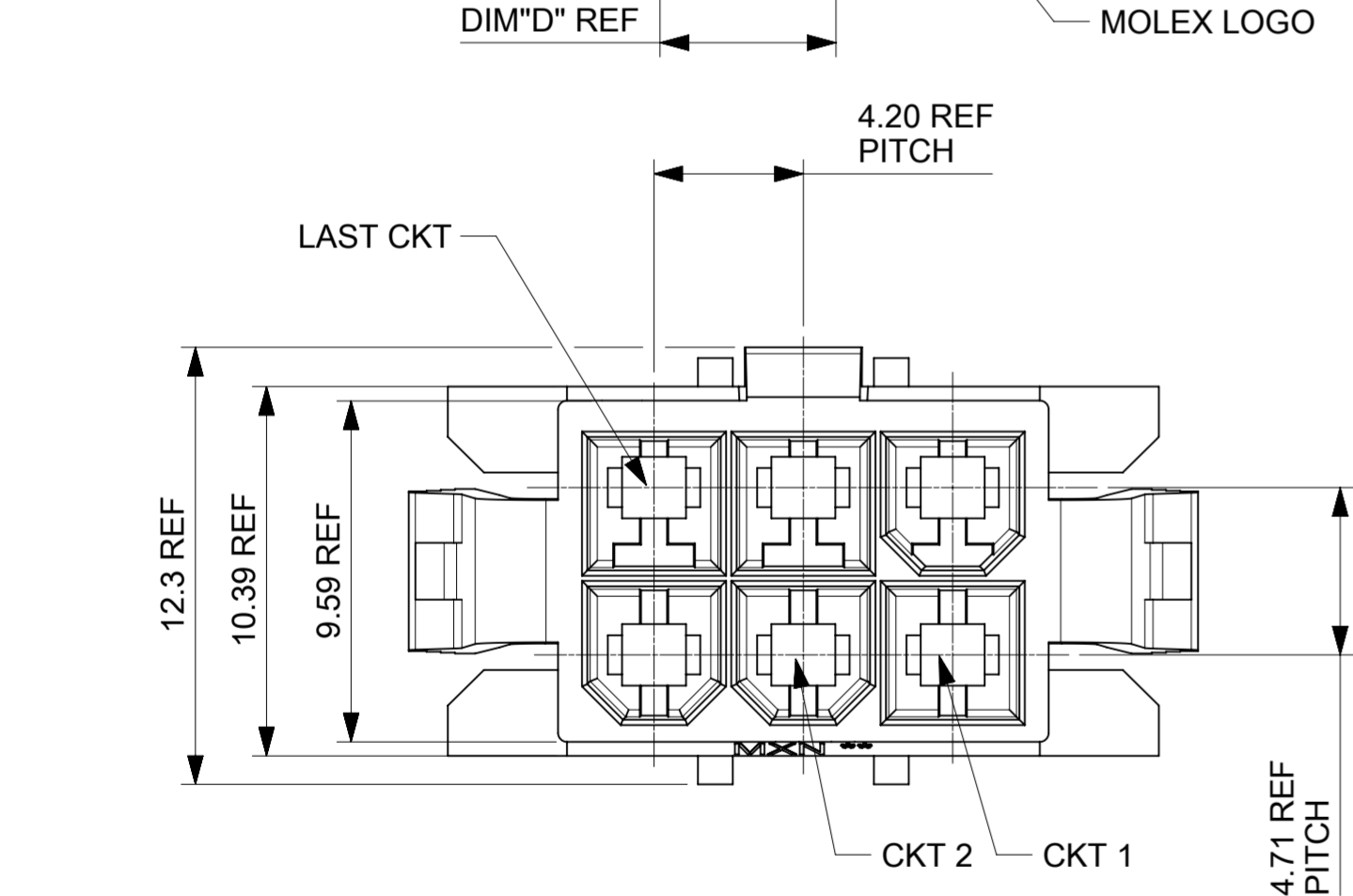
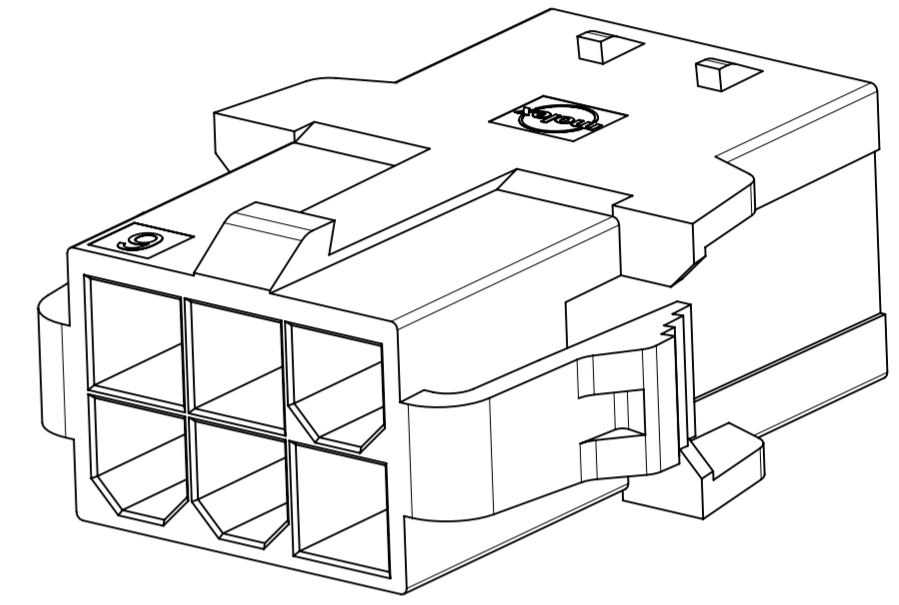

- NOTES:
- MATERIAL: NYLON, UL 94V-0 AND GLOW WIRE CAPABLE PER IEC60335-1; COLOR: BLACK
 - FINISH: NONE
 - PRODUCT SPECIFICATION: 2131370000-PS/2029880002-PS
APPLICATION SPECIFICATION: 2131370000-AS
 - PACKAGING SPECIFICATION: 172762-0001-PK
REFER TO AS-45499-001 FOR MOISTURIZING NYLON CONNECTOR PARTS.
 - THIS PART TO BE USED WITH FEMALE TERMINAL SERIES 172765, 203070 AND TPA SERIES 172709-2***.
 - THIS PART MATES WITH SERIES 172708-1***
 - THIS PART CONFORMS TO CLASS 'B' REQUIREMENTS OF COSMETIC SPECIFICATION PS-45499-002.
 - SEE DRAWING 1727090002-SD FOR OTHER TPA INFORMATION.
 - SEE DRAWING 1727080002-SD FOR OTHER RECEPTACLE INFORMATION.
 - SEE DRAWINGS SD-172718-0000 AND 2029880001-PSD FOR OTHER CRIMP TERMINAL INFORMATION.

RECOMMENDED PANEL CUT-OUT DIMENSIONS
PANEL THICKNESS 0.80-2.00MM

THIS DRAWING CONTAINS INFORMATION THAT IS PROPRIETARY TO MOLEX ELECTRONIC TECHNOLOGIES, LLC AND SHOULD NOT BE USED WITHOUT WRITTEN PERMISSION

DIMENSION UNITS	SCALE	CURRENT REV DESC:		molex		
mm	NTS					
GENERAL TOLERANCES (UNLESS SPECIFIED)				SD-DRAWING OF MINI-FIT SIGMA DR PLUG		
ANGULAR TOL	±	°		PRODUCT CUSTOMER DRAWING		
4 PLACES	±	EC NO: 735375		DOCUMENT NUMBER		
3 PLACES	±	DRWN: JERRYW8		2023/01/06		
2 PLACES	±	CHK'D: XQZHANG		2023/02/01		
1 PLACE	±	APPR: XQZHANG		2023/02/01		
0 PLACES	±	INITIAL REVISION:		DOC TYPE DOC PART REVISION		
DRAFT WHERE APPLICABLE MUST REMAIN WITHIN DIMENSIONS		THIRD ANGLE PROJECTION		DRAWING		SHEET NUMBER
		SERIES		MATERIAL NUMBER		CUSTOMER
		A2-SIZE		172767		SEE TABLE
				GENERAL MARKET		1 OF 4

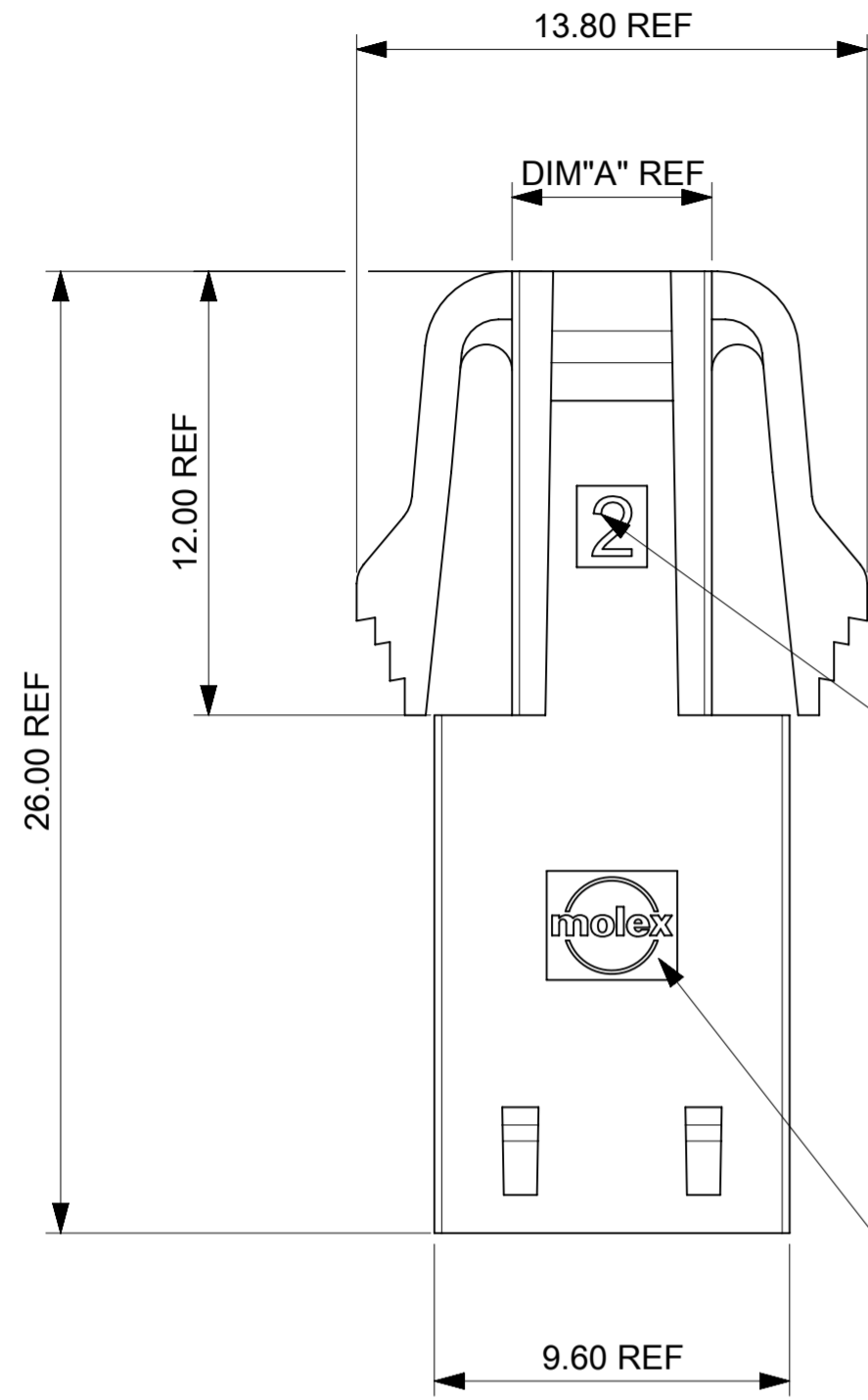

LAST CKT CODE

MOLEX LOGO

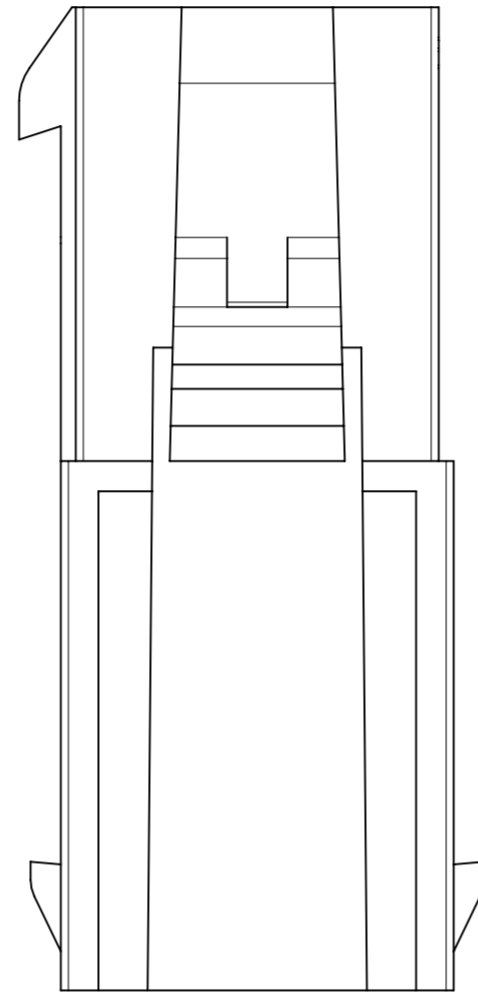

PLUG SERIES

MOLEX PLANT CODE

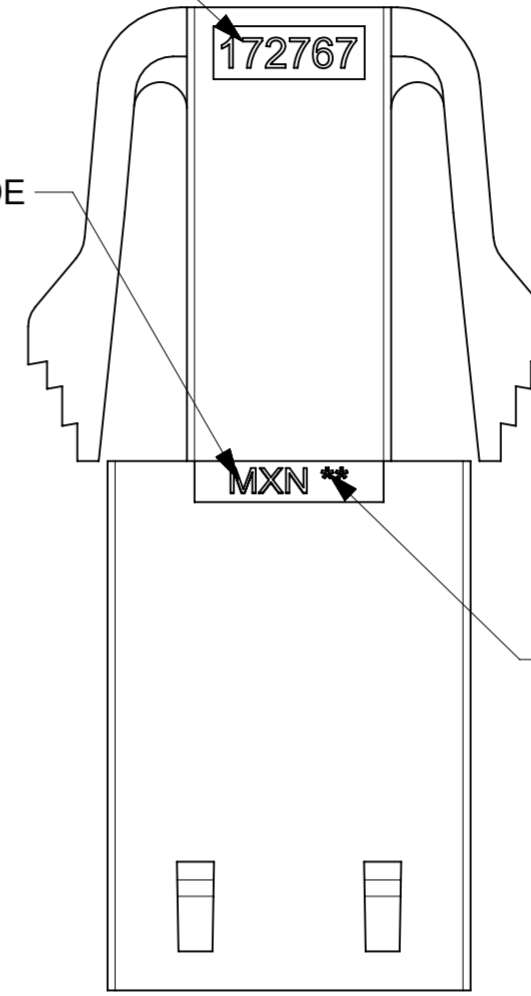

CAVITY CODE

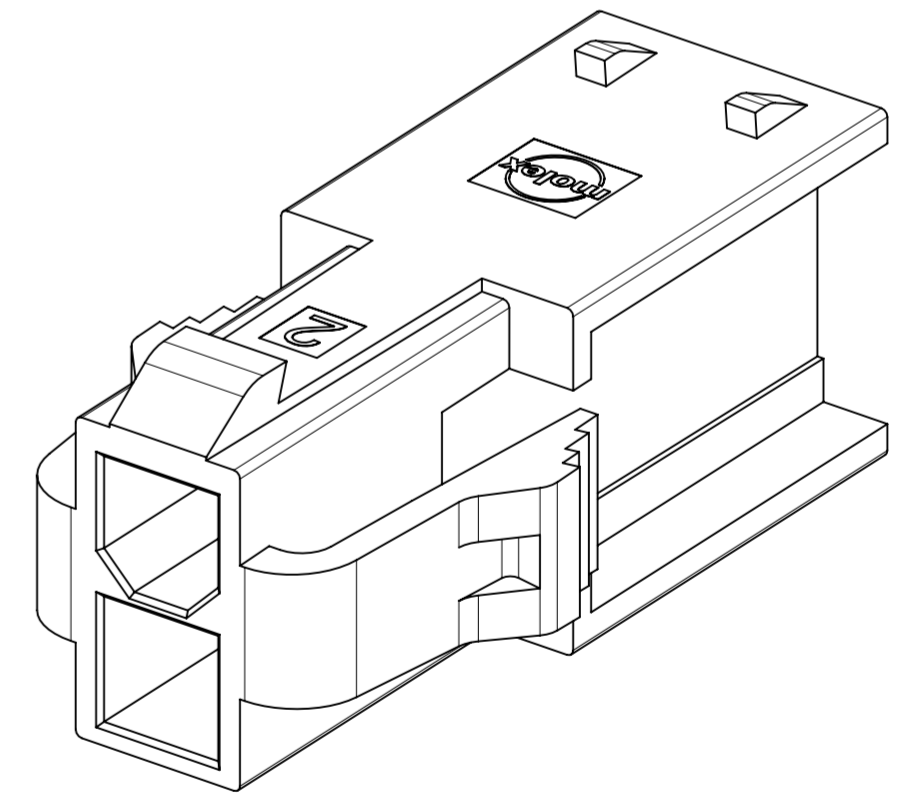
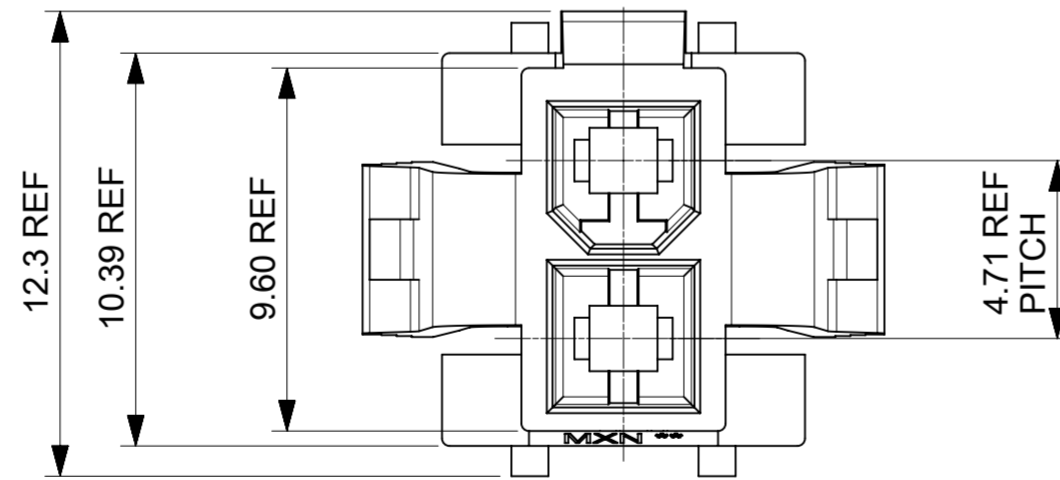
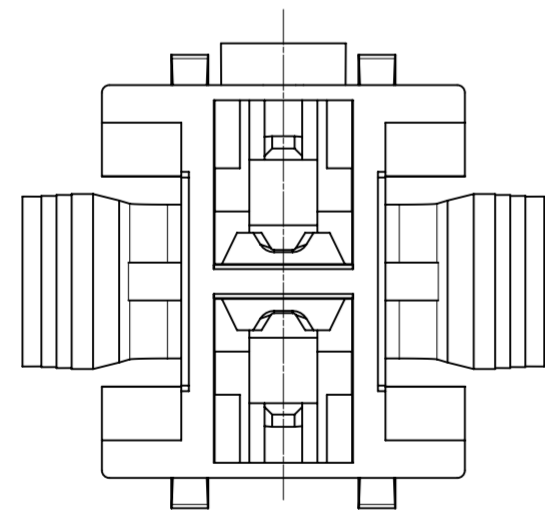

THIS DRAWING CONTAINS INFORMATION THAT IS PROPRIETARY TO MOLEX ELECTRONIC TECHNOLOGIES, LLC AND SHOULD NOT BE USED WITHOUT WRITTEN PERMISSION

DIMENSION UNITS	SCALE	CURRENT REV DESC:		molex					
mm	NTS								
GENERAL TOLERANCES (UNLESS SPECIFIED)				SD-DRAWING OF MINI-FIT SIGMA DR PLUG					
ANGULAR TOL	±	°	EC NO: 735375		DOCUMENT NUMBER		DOC TYPE	DOC PART	REVISION
4 PLACES	±		DRWN: JERRYW8	2023/01/06	1727670002-SD		PSD	000	A6
3 PLACES	±		CHK'D: XQZHANG	2023/02/01	PRODUCT CUSTOMER DRAWING				
2 PLACES	±	0.25	APPR: XQZHANG	2023/02/01					
1 PLACE	±	0.36	INITIAL REVISION:						
0 PLACES	±		DRWN: ALUO02	2019/09/24					
DRAFT WHERE APPLICABLE MUST REMAIN WITHIN DIMENSIONS			APPR: YXZHENG	2019/10/11					
THIRD ANGLE PROJECTION		DRAWING	SERIES	MATERIAL NUMBER	CUSTOMER	SHEET NUMBER			
		A2-SIZE	172767	SEE TABLE	GENERAL MARKET	2 OF 4			

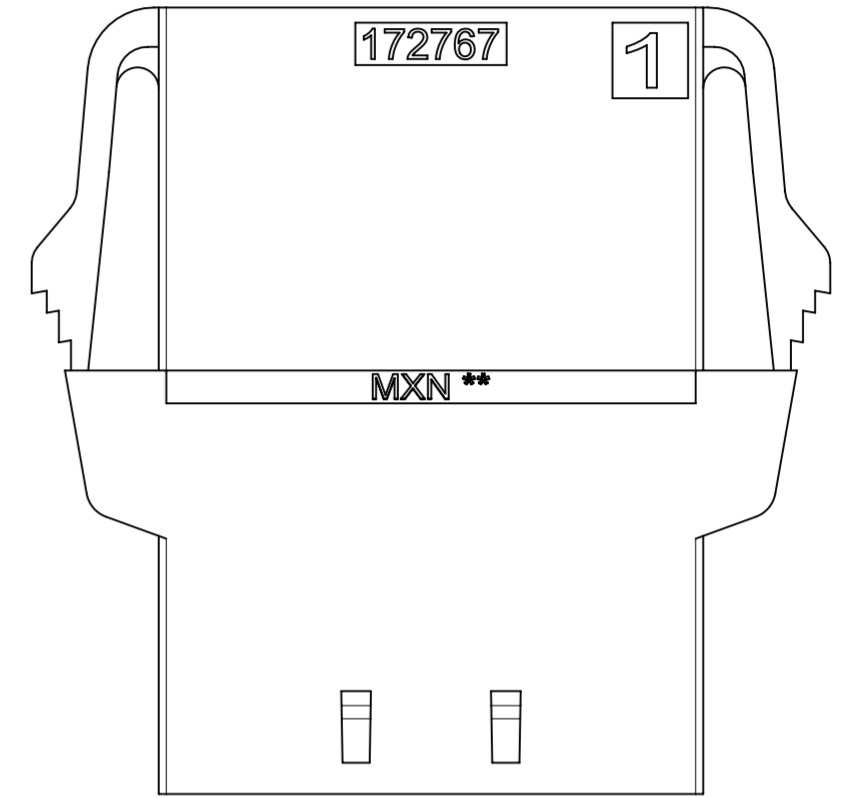
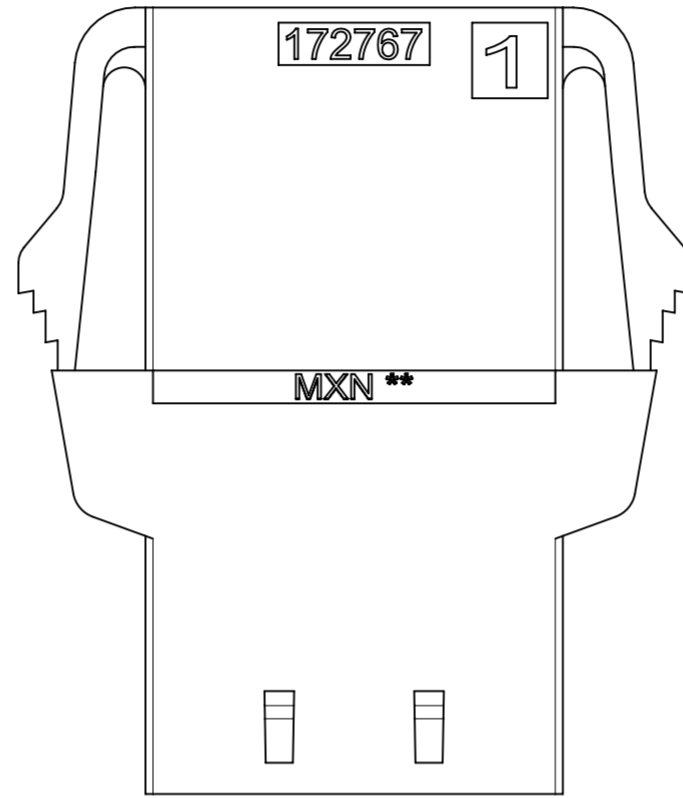
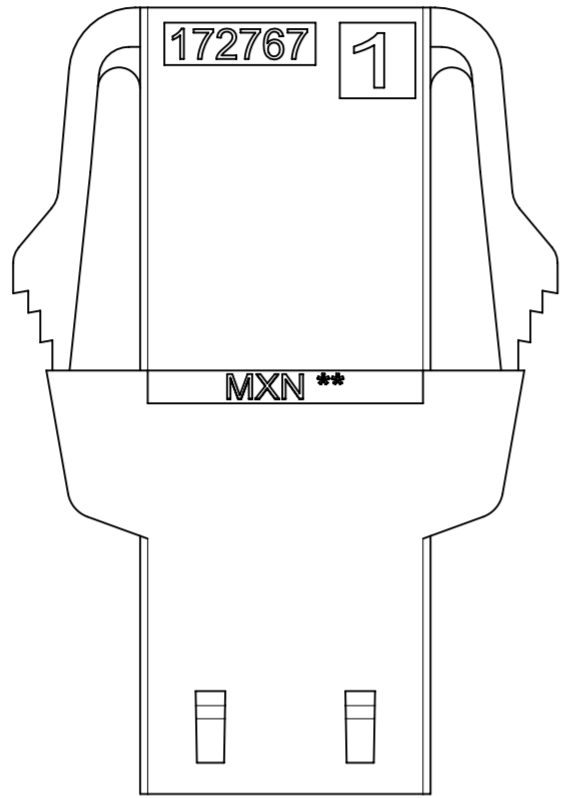
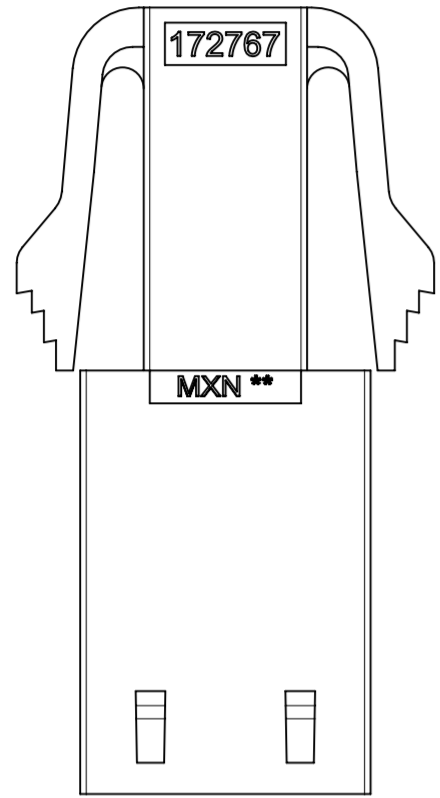
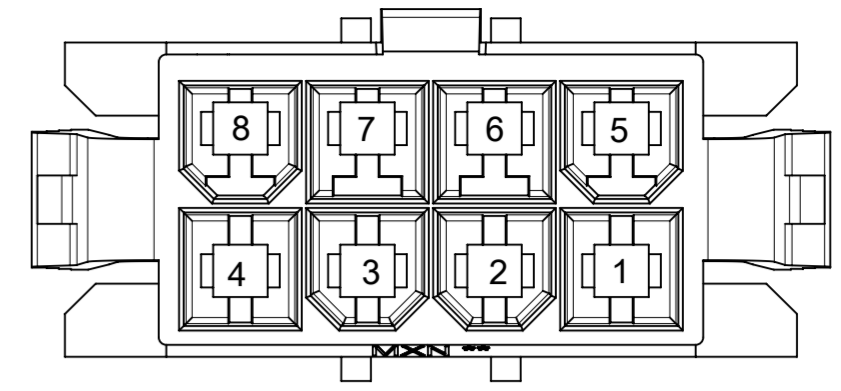
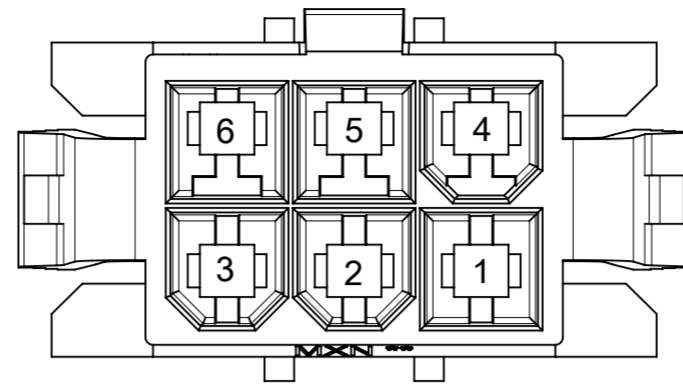
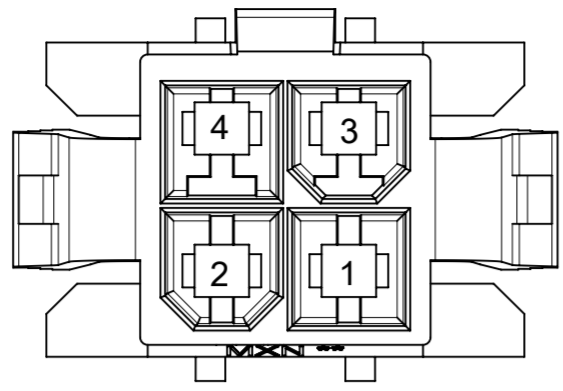
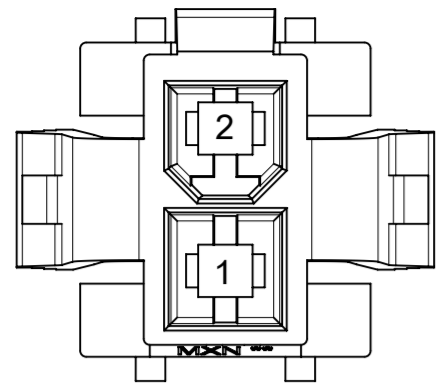

2-CKT

4-CKT

6-CKT

8-CKT

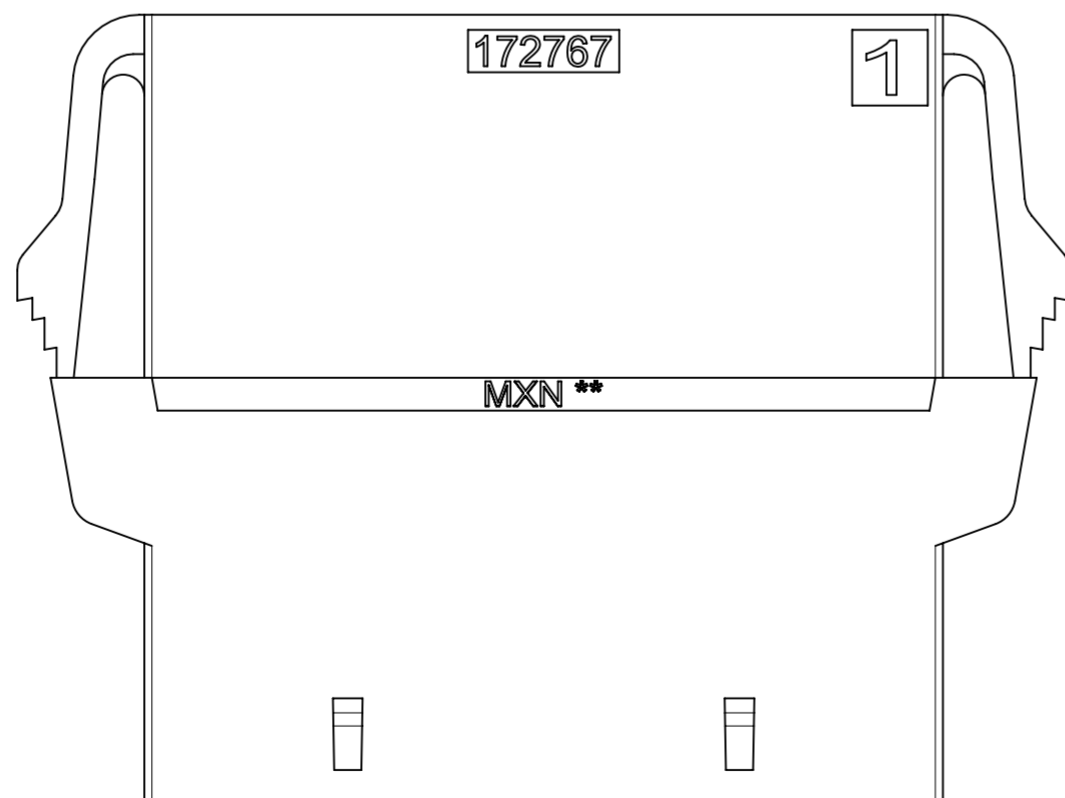
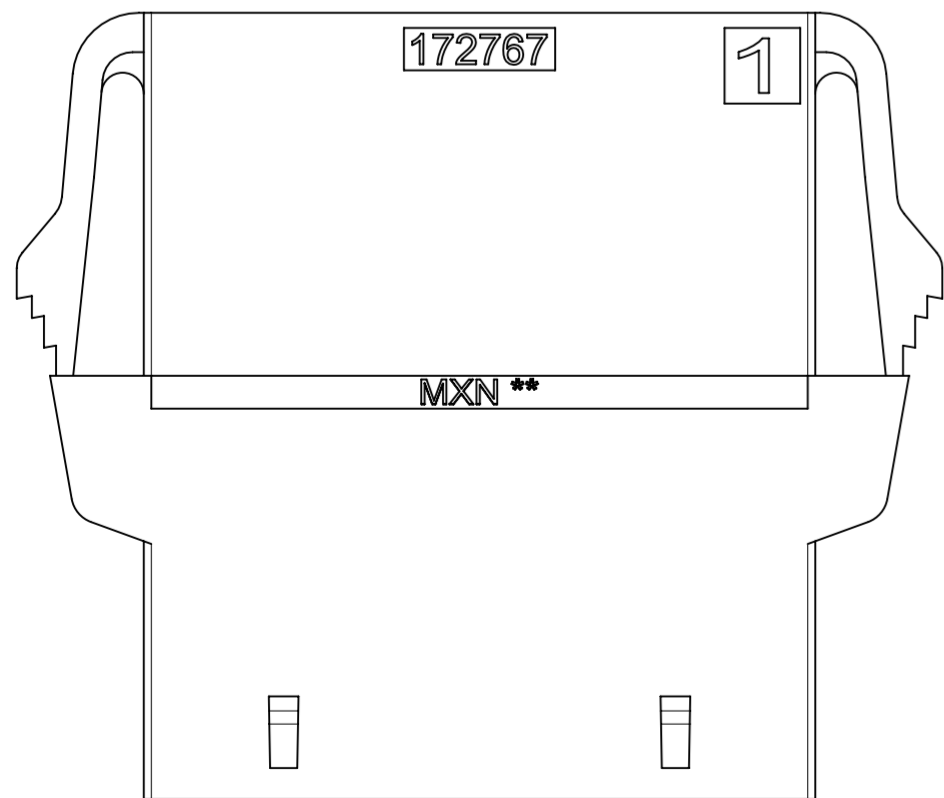
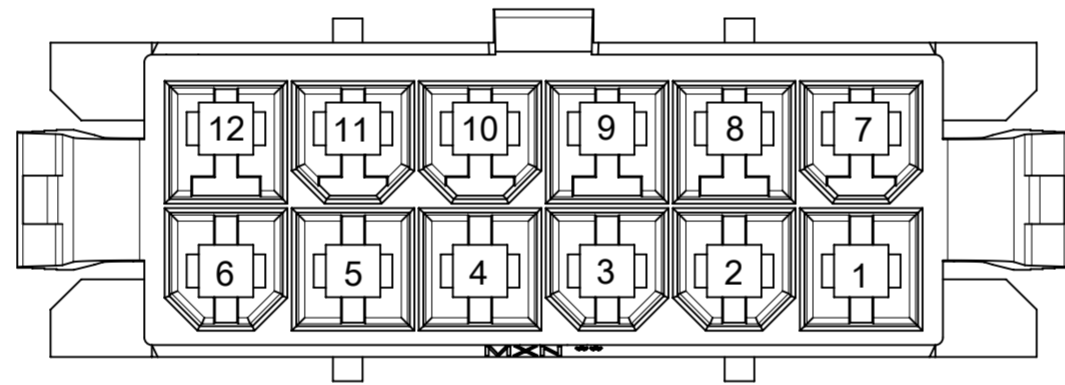
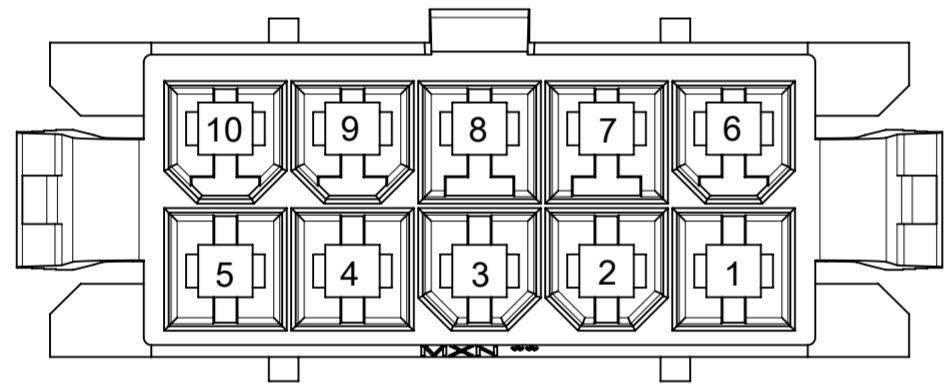

10-CKT

12-CKT

THIS DRAWING CONTAINS INFORMATION THAT IS PROPRIETARY TO MOLEX ELECTRONIC TECHNOLOGIES, LLC AND SHOULD NOT BE USED WITHOUT WRITTEN PERMISSION

DIMENSION UNITS	SCALE	CURRENT REV DESC:		molex		
mm	NTS					
GENERAL TOLERANCES (UNLESS SPECIFIED)				SD-DRAWING OF MINI-FIT SIGMA DR PLUG		
ANGULAR TOL	± °	EC NO: 735375		PRODUCT CUSTOMER DRAWING		
4 PLACES	±	DRWN: JERRYW8	2023/01/06	DOCUMENT NUMBER		
3 PLACES	±	CHK'D: XQZHANG	2023/02/01	1727670002-SD		
2 PLACES	± 0.25	APPR: XQZHANG	2023/02/01	DOC TYPE	DOC PART	REVISION
1 PLACE	± 0.36	INITIAL REVISION:		PSD 000 A6		
0 PLACES	±	DRWN: ALUO02	2019/09/24	MATERIAL NUMBER		
DRAFT WHERE APPLICABLE MUST REMAIN WITHIN DIMENSIONS		APPR: YXZHENG	2019/10/11	CUSTOMER		SHEET NUMBER
		THIRD ANGLE PROJECTION	DRAWING	SERIES	GENERAL MARKET	3 OF 4
			A2-SIZE	172767		

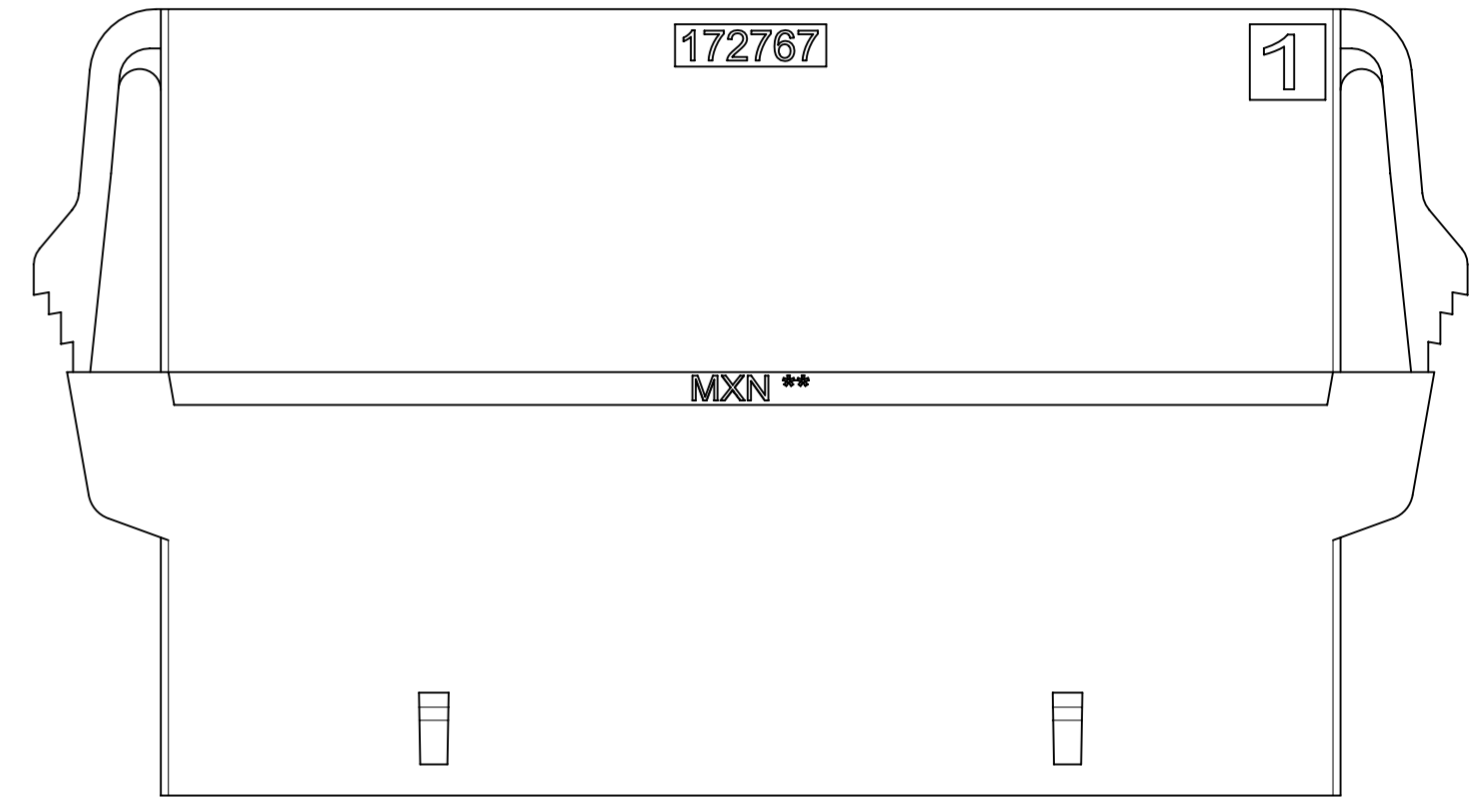
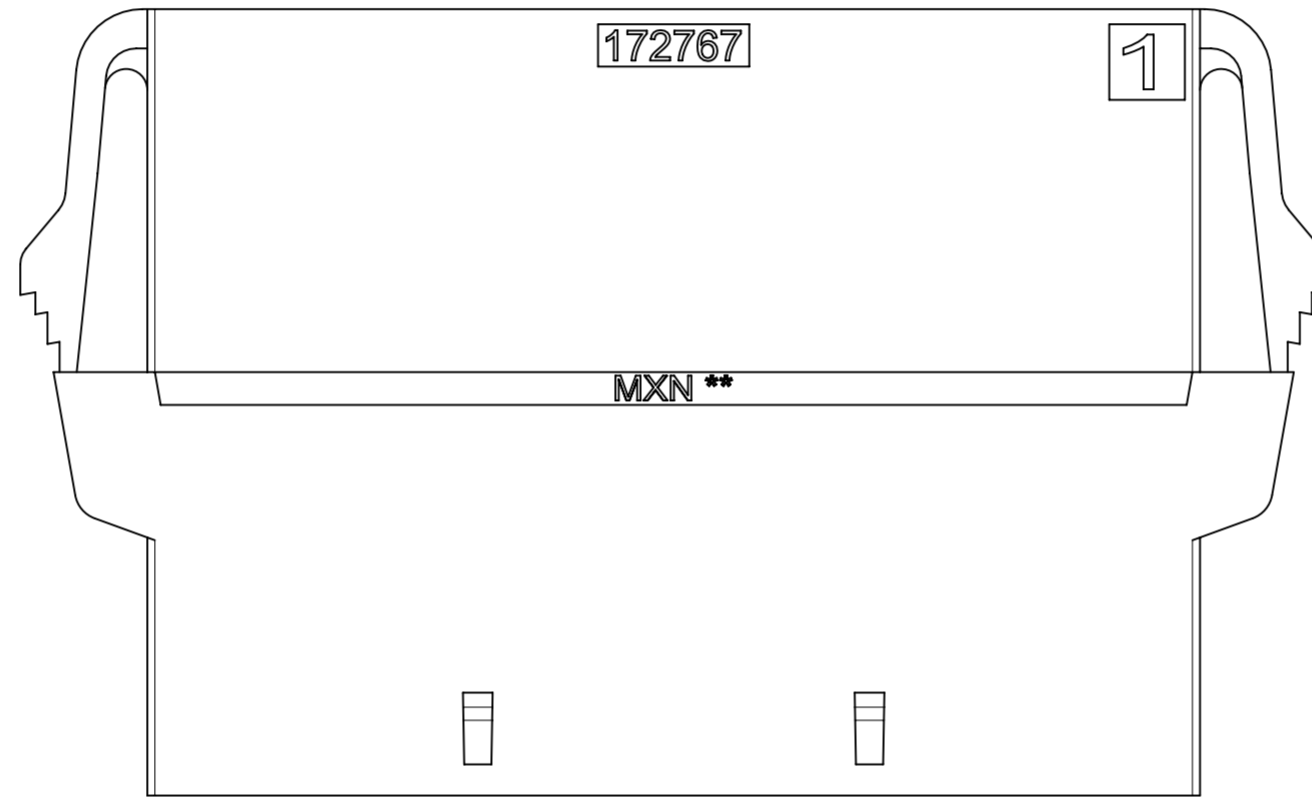
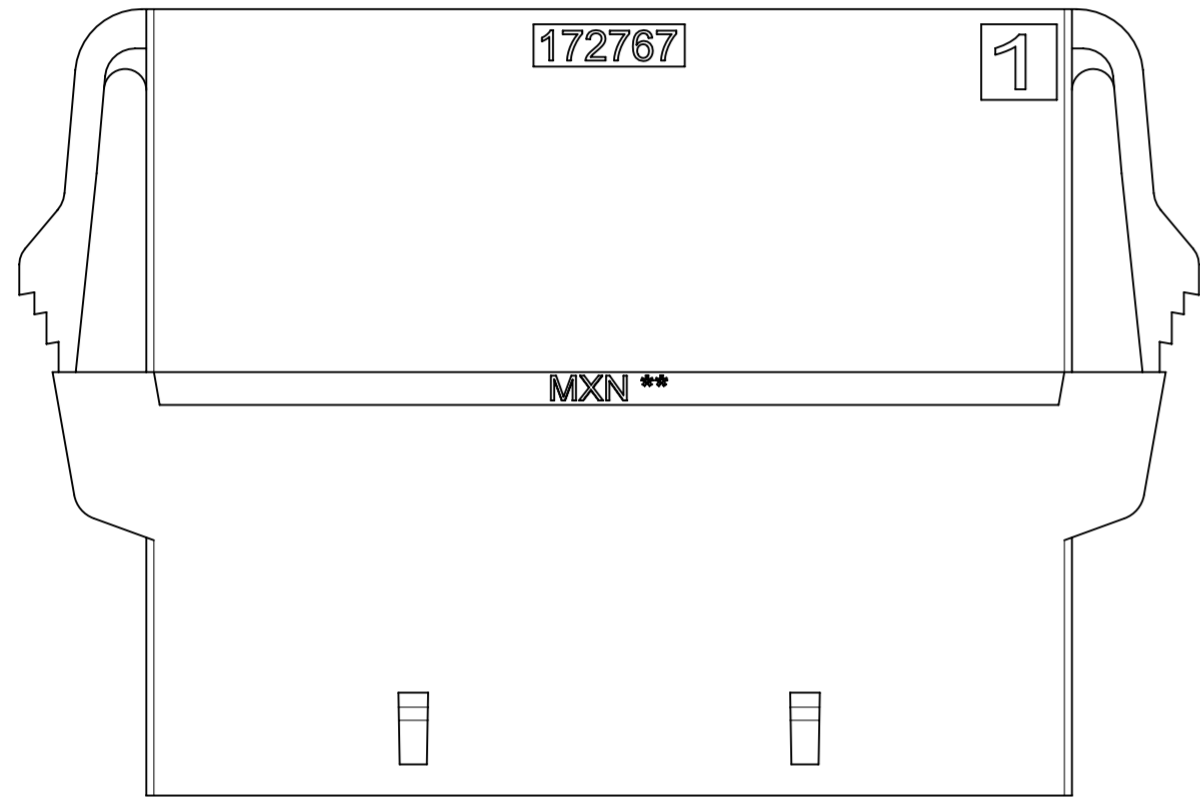
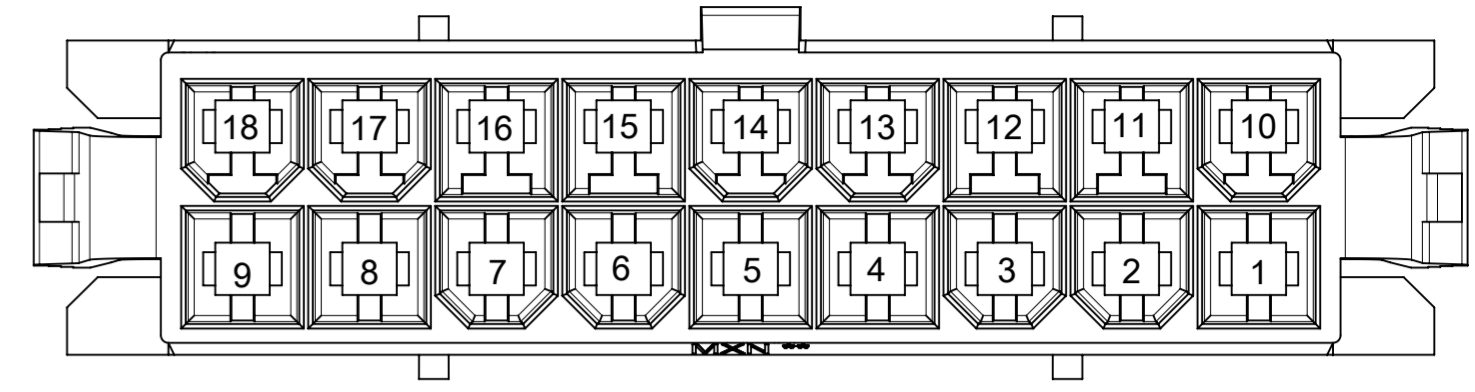
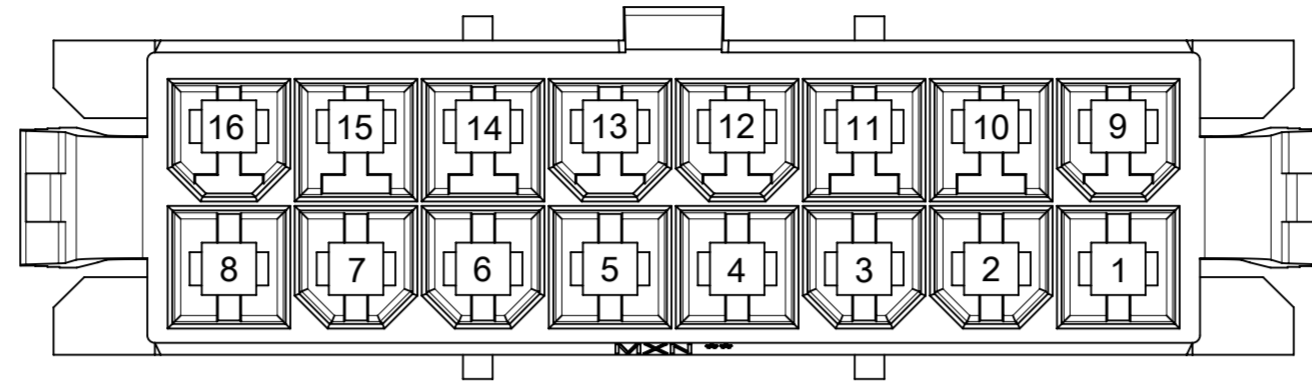
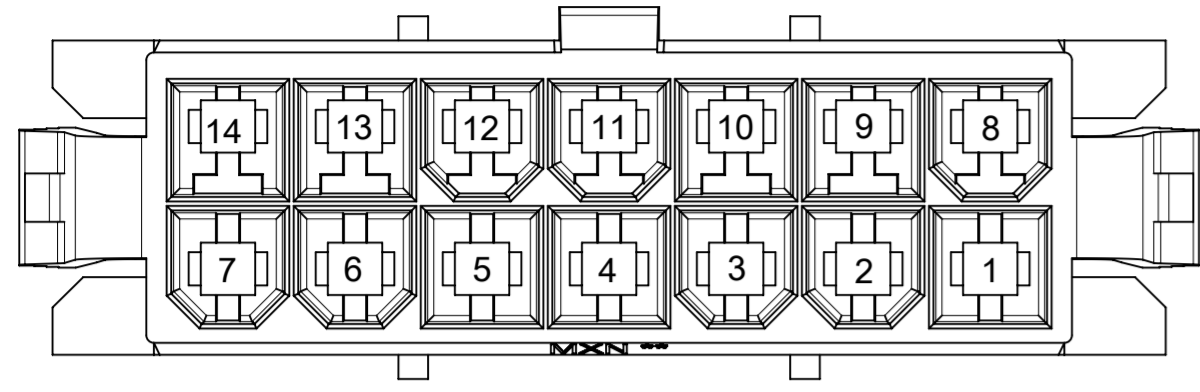

14-CKT

16-CKT

18-CKT

THIS DRAWING CONTAINS INFORMATION THAT IS PROPRIETARY TO MOLEX ELECTRONIC TECHNOLOGIES, LLC AND SHOULD NOT BE USED WITHOUT WRITTEN PERMISSION

DIMENSION UNITS	SCALE	CURRENT REV DESC:		molex			
mm	NTS						
GENERAL TOLERANCES (UNLESS SPECIFIED)				SD-DRAWING OF MINI-FIT SIGMA DR PLUG			
ANGULAR TOL	±	°		PRODUCT CUSTOMER DRAWING			
4 PLACES	±	EC NO: 735375		DOCUMENT NUMBER			
3 PLACES	±	DRWN: JERRYW8		2023/01/06			
2 PLACES	±	CHK'D: XQZHANG		2023/02/01			
1 PLACE	±	APPR: XQZHANG		2023/02/01			
0 PLACES	±	INITIAL REVISION:		SERIES			
DRAFT WHERE APPLICABLE MUST REMAIN WITHIN DIMENSIONS		THIRD ANGLE PROJECTION		DRAWING		MATERIAL NUMBER	
				A2-SIZE		SEE TABLE	
		2019/10/11		172767		GENERAL MARKET	
		2019/09/24		172767		CUSTOMER	
		2019/10/11		172767		SHEET NUMBER	
		2019/10/11		172767		4 OF 4	

DOCUMENT STATUS	P1	RELEASE DATE	2023/02/01	07:45:19
-----------------	----	--------------	------------	----------