

# **xWR1843 Evaluation Module (xWR1843BOOST) Single-Chip mmWave Sensing Solution**

---



---

The xWR1843 BoosterPack™ from Texas Instruments™ is an easy-to-use evaluation board for the xWR1843 mmWave sensing device, with direct connectivity to the microcontroller (MCU) LaunchPad™ Development Kit. The BoosterPack contains everything required to start developing software for on-chip C67x DSP core and low-power Arm® R4F controllers, including onboard emulation for programming and debugging as well as onboard buttons and LEDs for quick integration of a simple user interface.

## **Contents**

1	Getting Started .....	2
1.1	Introduction .....	2
1.2	Key Features .....	2
1.3	Kit Contents.....	2
2	Hardware.....	3
2.1	Block Diagram.....	5
2.2	Power Connections.....	5
2.3	Connectors .....	6
2.4	PC Connection .....	9
2.5	Connecting the BoosterPack to the DCA1000 .....	9
2.6	Connecting the BoosterPack to the LaunchPad or the MMWAVE-DEVPACK.....	10
2.7	Antenna.....	11
2.8	Jumpers, Switches, and LEDs.....	13
3	Design Files and Software Tools.....	16
3.1	Hardware .....	16
3.2	Software, Development Tools, and Example Code.....	16
4	Design Revision History .....	18
5	Mechanical Mounting of PCB.....	18
6	PCB Storage and Handling Recommendations .....	19
7	Troubleshooting .....	19
8	References .....	19

## **Trademarks**

BoosterPack, Texas Instruments, LaunchPad, Code Composer Studio are trademarks of Texas Instruments.

Arm is a registered trademark of Arm Limited.

Windows is a registered trademark of Microsoft Corporation.

All other trademarks are the property of their respective owners.

## 1 Getting Started

### 1.1 Introduction

The xWR1843 BoosterPack from Texas Instruments is an easy-to-use evaluation board for the xWR1843 mmWave sensing device, with direct connectivity to the microcontroller (MCU) LaunchPad Development Kit. The BoosterPack contains everything required to start developing software for on-chip C67x DSP core and low-power ARM R4F controllers, including onboard emulation for programming and debugging as well as onboard buttons and LEDs for quick integration of a simple user interface.

The standard 20-pin BoosterPack headers make the device compatible with a wide variety of TI MCU LaunchPads and enables easy prototyping.

### 1.2 Key Features

- Two 20-pin LaunchPad connectors that leverages the ecosystem of the TI LaunchPad
- XDS110 based JTAG emulation with a serial port for onboard QSPI flash programming
- Back-channel UART through USB-to-PC for logging purposes
- Onboard antenna
- 60-pin, high-density (HD) connector for raw analog-to-digital converter (ADC) data over LVDS and trace-data capability
- Onboard CAN-FD transceiver
- One button and two LEDs for basic user interface
- 5-V power jack to power the board

### 1.3 Kit Contents

The following items are included with the xWR1843BOOST kit.

- xWR1843 evaluation board
- Mounting brackets, screws, and nuts to place the printed-circuit board (PCB) vertical
- Micro USB cable to connect to PC

---

**NOTE:** A 5-V, > 2.5-A supply brick with a 2.1-mm barrel jack (center positive) is not included. TI recommends using an external power supply that complies with applicable regional safety standards, such as UL, CSA, VDE, CCC, PSE, and more. The length of the power cable should be < 3 m.

---

#### 1.3.1 mmWave Proximity Demo

TI provides sample demo codes to easily get started with the xWR1843 evaluation module (EVM) and to experience the functionality of the xWR1843 radar sensor. For details on getting started with these demos, see [www.ti.com/tool/mmwave-sdk](http://www.ti.com/tool/mmwave-sdk).

## 2 Hardware

Figure 1 and Figure 2 show the front and rear view of the EVM, respectively.

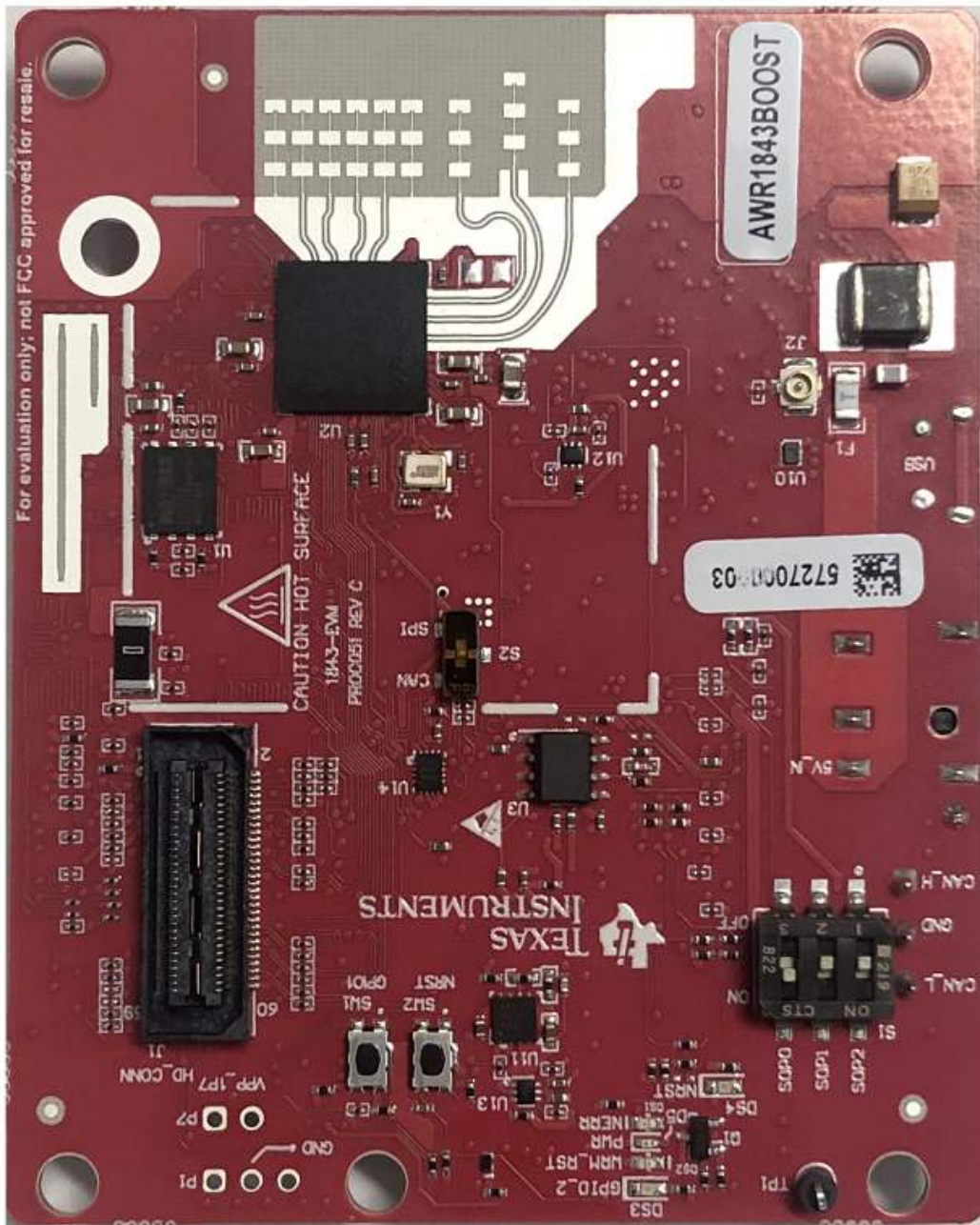

Figure 1. EVM (Front)



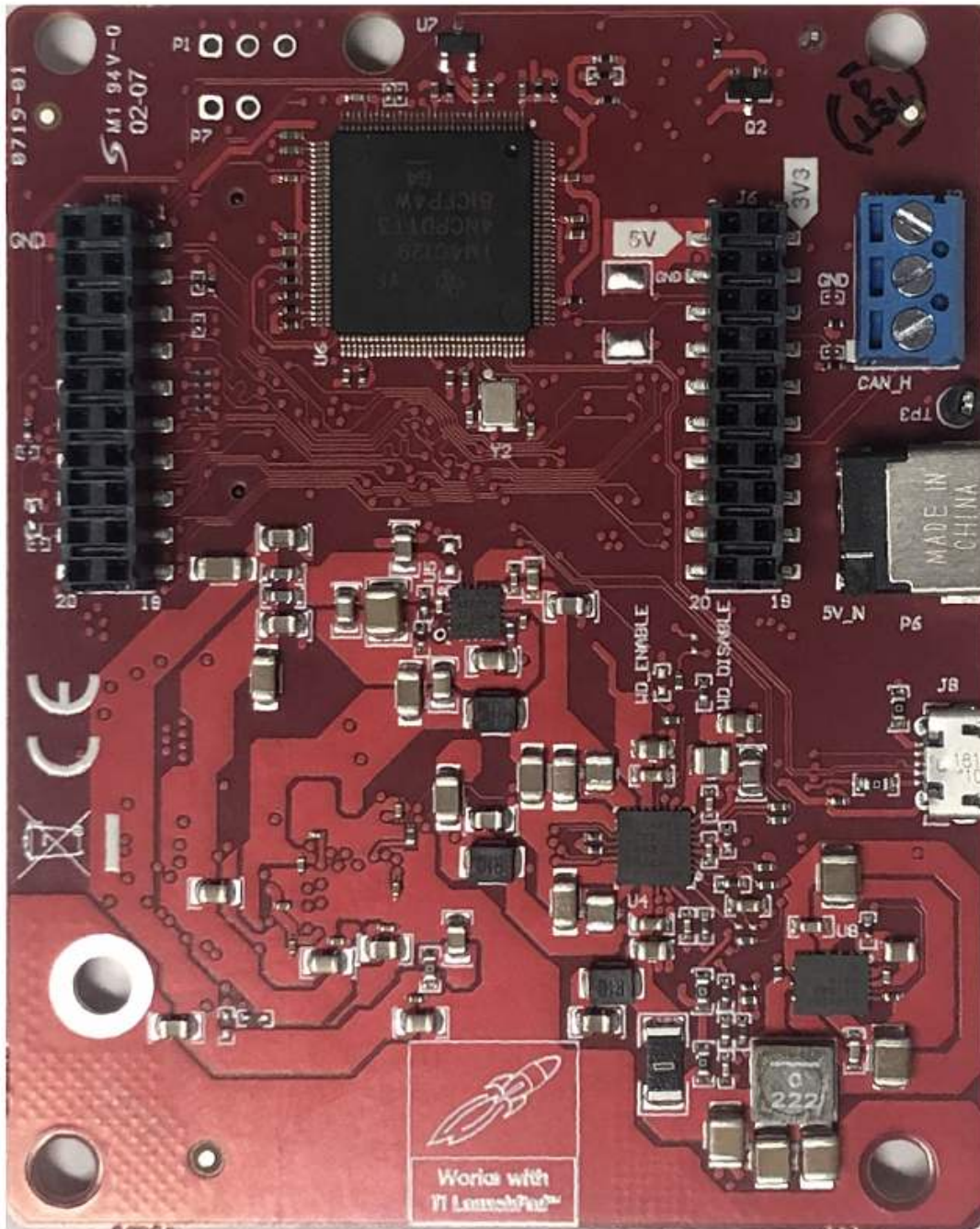

Figure 2. EVM (Rear)

## 2.1 Block Diagram

Figure 3 shows the block diagram.

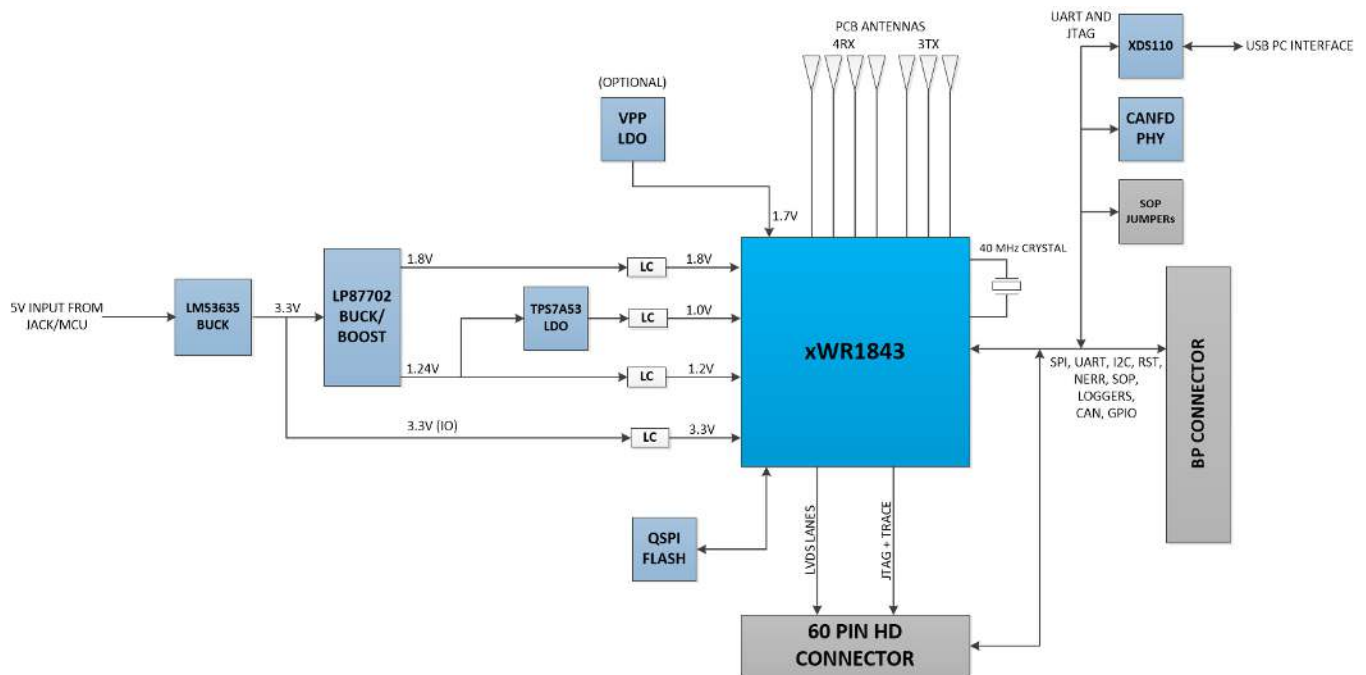

Figure 3. Block Diagram

## 2.2 Power Connections

The BoosterPack is powered by the 5-V power jack (2.5-A current limit), shown in Figure 4. As soon as the power is provided, the NRST and 5-V LEDs should glow, indicating that the board is powered on.

**NOTE:** After the 5-V power supply is provided to the EVM, it is recommended to press the NRST switch (SW2) one time to ensure a reliable boot-up state.

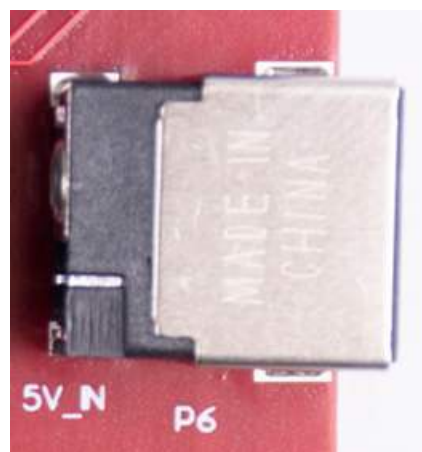

Figure 4. Power Connector

## 2.3 Connectors

### 2.3.1 20-Pin BoosterPack Connectors

The BoosterPack has the standard LaunchPad connectors (J5 and J6, shown in [Figure 5](#)) that enable it to be directly connected to all TI MCU LaunchPads. While connecting the BoosterPack to other LaunchPads, ensure the pin-1 orientation is correct by matching the 3V3 and 5-V signal marking on the boards.



**Figure 5. 20-Pin BoosterPack Connectors**

[Table 1](#) and [Table 2](#) provide the connector-pin information.

**Table 1. J5 Connector Pin**

Pin Number	Description	Pin Number	Description
1	NERROUT	2	GND
3	NERRIN	4	DSS LOGGER
5	MCUCLK OUT	6	SPI_CS
7	NC	8	GPIO01
9	MSS LOGGER	10	nRESET
11	WARMRST	12	SPI_MOSI
13	BSS LOGGER	14	SPI_MISO
15	SOP2	16	HOSTINT
17	SOP1	18	GPIO02
19	SOP0	20	NC

**Table 2. J6 Connector Pin**

Pin Number	Description	Pin Number	Description
1	3V3	2	5 V
3	NC	4	GND
5	RS232RX (Tx from AWR device)	6	ANA1 <sup>(1)</sup>
7	RS232RX (Rx into AWR device)	8	ANA2 <sup>(1)</sup>
9	SYNC_IN	10	ANA3 <sup>(1)</sup>
11	NC	12	ANA4 <sup>(1)</sup>
13	SPI_CLK	14	PGOOD (onboard VIO) <sup>(2)</sup>
15	GPIO0	16	PMIC Enable <sup>(3)</sup>
17	SCL	18	SYNC_OUT
19	SDA	20	PMIC CLK OUT

<sup>(1)</sup> Voltage input to the GPADC available on the xWR1843.

<sup>(2)</sup> Indicates the state of the onboard VIO supply for the AWR device coming from the onboard PMIC. A HIGH on the PGOOD signal (3.3 V) indicates the supply is stable. Because the I/Os are not failsafe, the MCU must not drive any I/O signals to the AWR device before this I/O supply is stable to avoid leakage current into the I/Os.

<sup>(3)</sup> Controls the onboard PMIC enable. The MCU can use this to shut down the PMIC and AWR device during the periods it does not use the AWR device and save power. The power up of the PMIC takes approximately 5 ms once the enable signal is made high.

### 2.3.2 60-Pin HD Connector

The 60-pin HD connector provides the high speed LVDS data, control signals (SPI, UART, I<sup>2</sup>C, NRST, NERR, SOPs) and JTAG debug signals. The connector can be connected to the MMWAVE-DEVPACK board to further get to the standard TSW1400 EVM. [Figure 6](#) shows the HD connector, and [Table 3](#) provides the connector information.



**Figure 6. HD Connector**

**Table 3. J1 Connector Pin**

Pin Number	Description	Pin Number	Description
1	5V	2	5V
3	5V	4	TDO
5	TDI	6	TCK
7	SPI_CS	8	TMS
9	SPI_CLK	10	HOSTINT
11	SPI_MOSI	12	SPI_MISO
13	PGOOD (onboard VIO) <sup>(1)</sup>	14	NERROUT
15	DMM_CLK	16	SYNC_IN
17	DMM_SYNC	18	GND
19	TRACE_DATA0	20	NC
21	TRACE_DATA1	22	NC
23	TRACE_DATA2	24	GND
25	TRACE_DATA3	26	LVDS_FRCLKP
27	TRACE_DATA4	28	LVDS_FRCLKM
29	TRACE_DATA5	30	GND
31	TRACE_DATA6	32	NC
33	TRACE_DATA7	34	NC
35	TRACE_DATA8	36	GND
37	TRACE_DATA9	38	NC
39	TRACE_DATA10	40	NC
41	TRACE_DATA11	42	GND

<sup>(1)</sup> Indicates the state of the onboard VIO supply for the AWR device coming from the onboard PMIC. A HIGH on the PGOOD signal (3.3 V) indicates the supply is stable. Because the I/Os are not failsafe, the MCU must not drive any I/O signals to the AWR device before this I/O supply is stable to avoid leakage current into the I/Os.

**Table 3. J1 Connector Pin (continued)**

Pin Number	Description	Pin Number	Description
43	TRACE_DATA12	44	LVDS_CLKP
45	TRACE_DATA13	46	LVDS_CLKM
47	TRACE_DATA14	48	GND
49	TRACE_DATA15	50	LVDS_1P
51	I2C_SDA	52	LVDS_1M
53	I2C_SCL	54	GND
55	RS232RX (Rx into AWR device)	56	LVDS_0P
57	RS232TX (Tx from AWR device)	58	LVDS_0M
59	nRESET	60	GND

### 2.3.3 CAN Interface Connector

The J3 connector provides the CAN\_L and CAN\_H signals from the onboard GAND-FD transceiver (TCAN1042HGVDRQ1). These signals can be directly wired to the CAN bus.

Because the digital CAN signals (Tx and Rx) are muxed with the SPI interface signals on the AWR device, one of the two paths must be selected. This is done by placing the switch S2 on the "CAN" position.

Figure 7 shows the CAN connector.

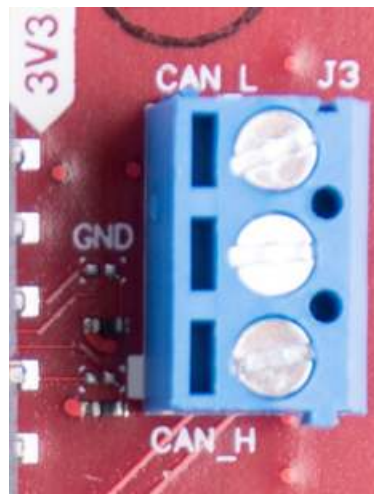
**Figure 7. CAN Connector**



## 2.4 PC Connection

The connectivity is provided through the micro USB connector over the onboard XDS110 (TM4C1294NCPDT) emulator. This connection provides the following interfaces to the PC:

- JTAG for Code Composer Studio™ (CCS) connectivity
- UART1 for flashing the onboard serial flash, downloading FW through Radar Studio, and getting application data sent through the UART
- MSS logger UART (can be used to get MSS code logs on the PC)

When the USB is connected to the PC, the device manager should recognize the following COM ports, shown in [Figure 8](#):

- XDS110 Class Application/User UART – UART1 port
- XDS110 Class Auxiliary Data Port – MSS logger port

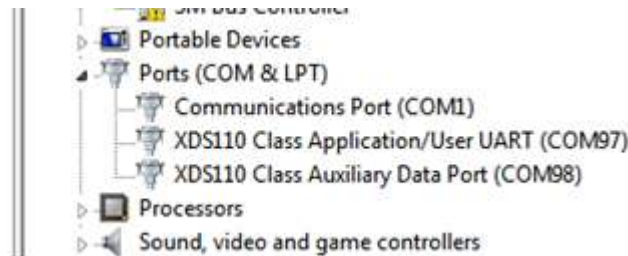

**Figure 8. COM Ports**

If Windows® is unable to recognize the COM ports, users must install the EMU pack available at [XDS Emulation Software Package](#).

## 2.5 Connecting the BoosterPack to the DCA1000

The BoosterPack can be connected to the DCA1000 FPGA platform to allow for LVDS streaming over Ethernet. For detailed information on how to capture LVDS data using the DCA1000, see the following resources.

- [DCA1000 Product Page](#)
- [DCA1000 User's Guide](#)
- [DCA1000 Training Video](#)

## 2.6 Connecting the BoosterPack to the LaunchPad or the MMWAVE-DEVPACK

The development pack may be required with the BoosterPack for the following use cases:

- Connecting to Radar Studio  
Radar Studio TSW1400+Devpack, mmwave Studio TSW1400+Devpack/DCA1000 tool is a tool that provides capability to configure the mmWave front end from the PC. This tool is available in the [DFP package](#) and refers to single dfp landing page for both pieces of software.
- Capturing high-speed LVDS data using the SW1400, TSW1400 or DCA1000 FPGA platform from TI (see [High Speed Data Capture and Pattern Generation Platform](#)).  
The TSW1400 FPGA platform allows users to capture the raw ADC data over the high-speed debug interface and post process it in the PC.
- Getting DSP trace data through the MIPI 60-pin interface
- Use the DMM interface

This BoosterPack can be stacked on top of the Launchpad or the [MMWAVE-DEVPACK](#) by using the two 20-pin connectors. The connectors do not have a key to prevent the misalignment of the pins or reverse connection. Hence, care must be taken to ensure reverse mounting does not take place.

On the xWR1843 BoosterPack, TI has provided 3V3 markings near pin 1, shown in [Figure 9](#). The same marking is provided on compatible LaunchPads (must be aligned before powering up the boards).

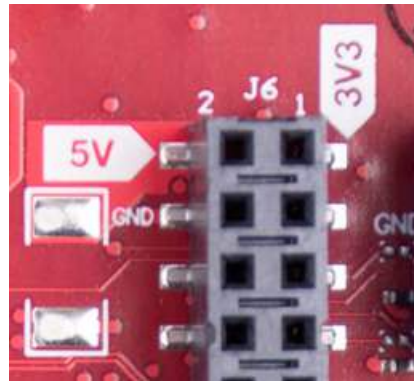

**Figure 9. 3V3 and 5V Marking on BoosterPack**

For details on these use cases, see the [MMWAVE-DEVPACK User's Guide](#).

---

**NOTE:** The DCA1000 EVM has internal DEVPACK functionality. For more information, see the [DCA1000EVM Data Capture Card User's Guide](#).

---

## 2.7 Antenna

The BoosterPack includes onboard-etched antennas for the four receivers and three transmitters that enable tracking multiple objects with their distance and angle information. This antenna design enables estimation of distance and elevation angle that enables object detection in a three-dimensional plane. [Figure 10](#) shows the PCB antennas.

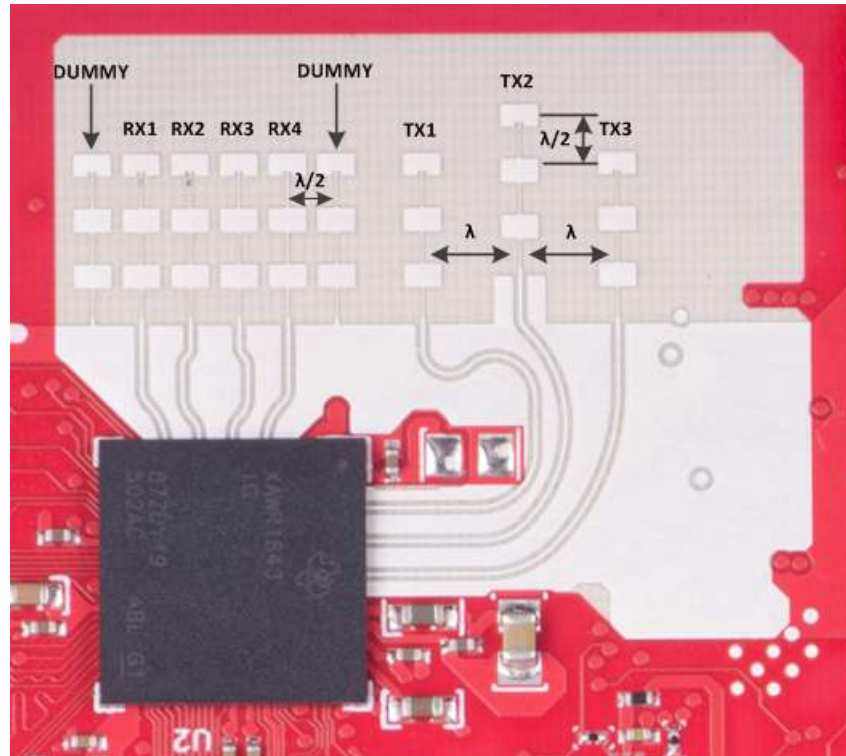

**Figure 10. RX and TX Antennas**

The antenna peak gain is  $> 10.5$  dBi across the frequency band of 76 to 81 GHz. The radiation pattern of the antenna in the horizontal plane (H-plane) and elevation plane (E-plane) is as shown in [Figure 11](#) and [Figure 12](#).

The beamwidth of the antenna design can be determined from the radiation patterns. For example, at 78 GHz, based on 3-dB drop in the gain as compared to bore sight, the horizontal 3dB-beamwidth is approximately  $\pm 28$  degrees (see [Figure 11](#)), and elevation 3dB-beamwidth is approximately  $\pm 14$  degrees (see [Figure 12](#)). Similarly, the horizontal 6dB-beamwidth is approximately  $\pm 50$  degrees (see [Figure 11](#)) and the elevation 6dB-beamwidth is approximately  $\pm 20$  degrees (see [Figure 12](#)).

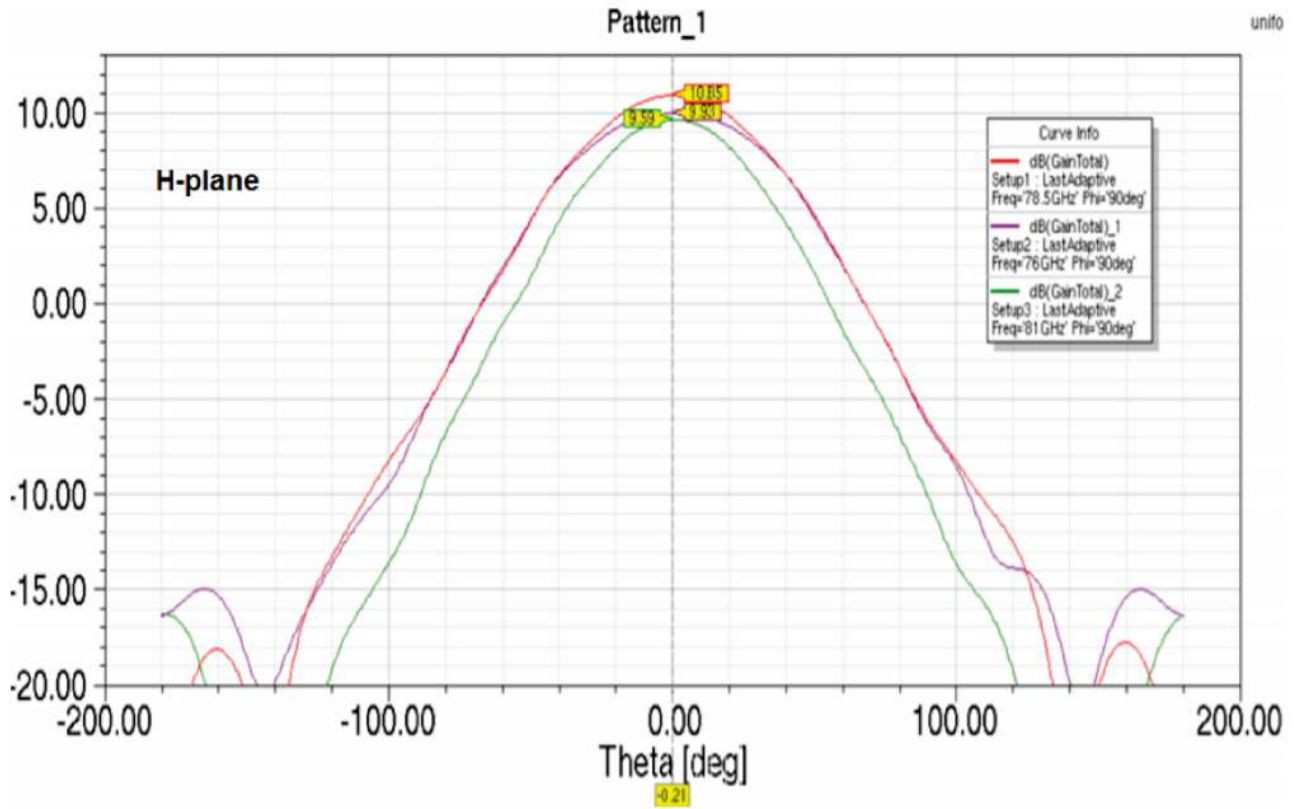

Figure 11. Antenna Pattern

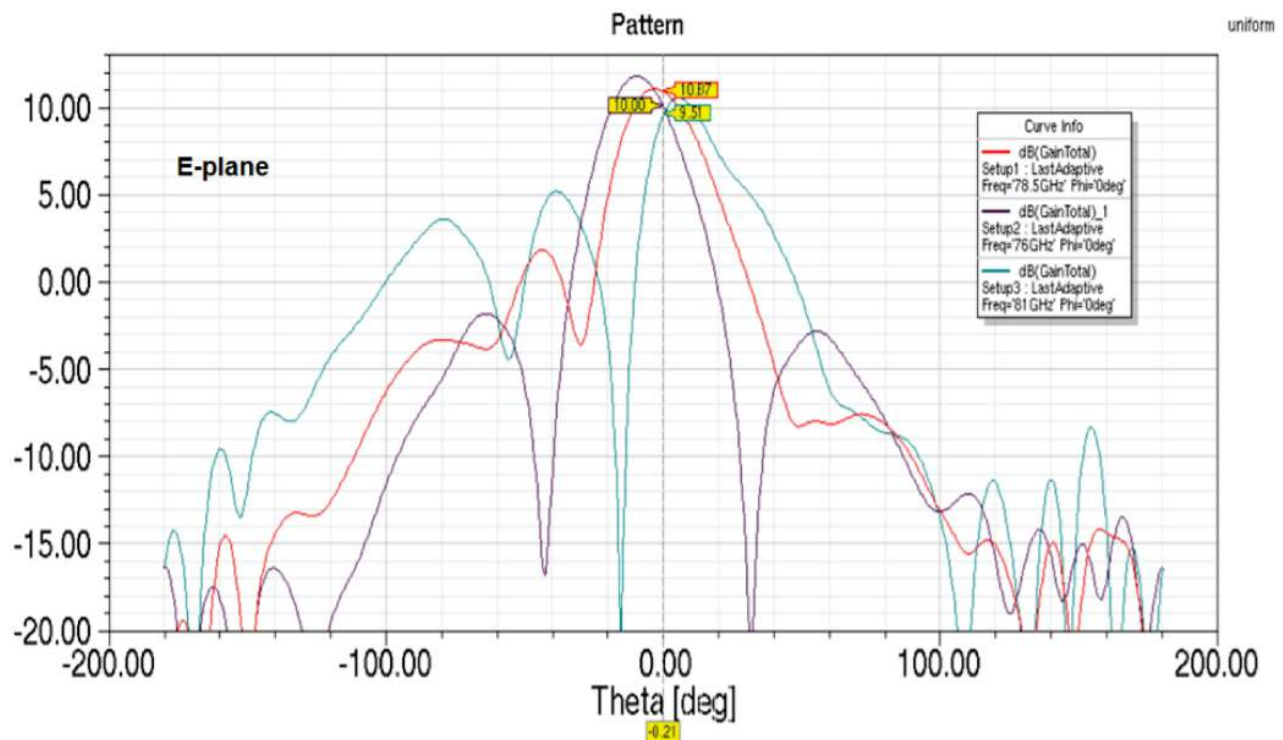

Figure 12. Antenna Pattern

---

**NOTE:** The xWR1843BOOST has been testing in the 76- to 77-GHz band and in the 77- to 81-GHz band across the temperature range of -20°C to 60°C.

---

**NOTE:** During operation, a minimum separation distance of 5 centimeters should be maintained between the user and the EVM.

---

## 2.8 Jumpers, Switches, and LEDs

### 2.8.1 Sense-on-Power (SOP) Jumpers

The xWR1843 device can be set to operate in three different modes based on the state of the SOP lines. These lines are sensed only during boot up of the AWR device. The state of the device is detailed by [Table 4](#).

The SOP mode is set using switch S1. When the switch position is 'ON', this refers to a 1. When the switch position is 'OFF', this refers to a 0.

**Table 4. SOP Switch Information**

Reference	Usage	Comments
SOP 2	SOP[2:0]	101 (SOP mode 5) = flash programming
SOP 1		001 (SOP mode 4) = functional mode
SOP 0		011 (SOP mode 2) = debug mode

[Figure 13](#) shows the SOP jumpers.

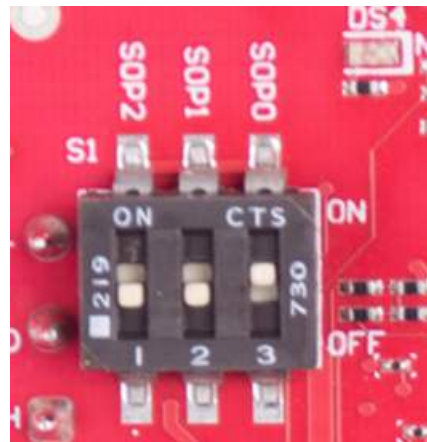

**Figure 13. SOP Jumpers**



### 2.8.2 Current Measurement

The R156 resistor enables the measurement of the current being consumed by the reference design (AWR device, PMIC, and LDOs) at a 3.3-V level.

To measure the current, resistor R156 must be removed and a series ammeter can be put across the resistor pins (shown in [Figure 14](#)).

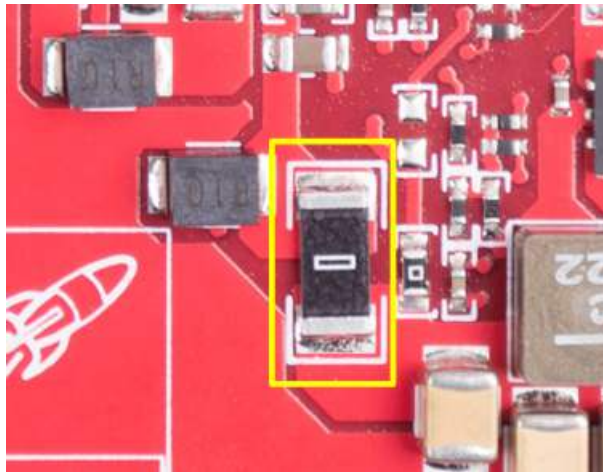

**Figure 14. Current Measure Resistor**

### 2.8.3 Push Buttons and LEDs

[Table 5](#) provides the switch and LED information.

**Table 5. Switch and LED Information**

Reference	Usage	Comments
SW2	RESET	Used to RESET the xWR1843 device. This signal is also brought out on the 20-pin connector and 60-pin HD connector so an external processor can control the AWR device. The onboard XDS110 can also use this reset.
SW1	GPIO_1	When pushed, the GPIO_1 is pulled to V <sub>CC</sub> .
DS2	Warm reset indication	This LED indicates the warm reset is triggered.
DS4	nRESET	This LED is used to indicate the state of nRESET pin. If this LED is glowing, the device is out of reset. This LED will glow only after the 5-V supply is provided.
DS1	Nerr_OUT	Glow if there is any HW error in the AWR device
DS3	GPIO_1	Glow when the GPIO is logic-1
D5	PWR	This LED indicates the presence of the 3.3-V supply

Figure 15 through Figure 20 show the location of switches and LEDs.



Figure 15. SW1



Figure 16. SW2



Figure 17. DS2



Figure 18. DS4



Figure 19. DS1



Figure 20. DS3

#### 2.8.4 Selection Between SPI and CAN Interface

The SPI and CAN interface are muxed on the same lines on the xWR1843 device. Based on the configuration, the user can select if the pins E14 and D13 must be connected to the 20-pin/HD connectors to provide the SPI interface OR to the onboard CANFD PHY (U3). This selection is done by the S2 switch.

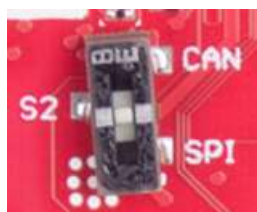

Figure 21. S2 Switch to Select Between SPI or CAN Interface

## 3 Design Files and Software Tools

### 3.1 Hardware

To view the schematics, assembly drawings, and BOM, see [AWR1843BOOST Schematic, Assembly Files, and BOM](#).

To view the design database and layout details, see [AWR1843BOOST Hardware Files](#).

---

**NOTE:** Boards with a Rev 'D' sticker have had capacitor C56 (VBGAP decoupling capacitor) changed from 0.22  $\mu$ F to 0.047  $\mu$ F (part number CGA2B3X7R1H473K050BB). TI recommends that customers incorporate this change with an equivalent capacitor in their designs.

---

### 3.2 Software, Development Tools, and Example Code

To enable quick development of end applications on the C67x DSP and R4F core in the xWR1843, TI provides a software development kit (SDK) that includes demo codes, software drivers, emulation packages for debug, and more. These can be found at [mmwave-sdk](#).

#### 3.2.1 LDO Bypass Requirement

The xWR1843BOOST utilizes a 1.0-V supply on the RF1 and RF2 power rails. To support the third transmitter, the VOUT\_PA output is connected to the RF2 power rail. For best performance and to prevent damage to the device, select the 'RF LDO Bypass Enable' and 'PA LDO I/P Disable' options in the Static Configuration when using mmWave Studio. Additionally, the LDO bypass can be configured using the AWR\_RF\_LDO\_BYPASS\_SB API. To enable the RF LDO Bypass and PA LDO I/P Disable through the API, issue an `ar1.RfLdoBypassConfig(0x3)` command.

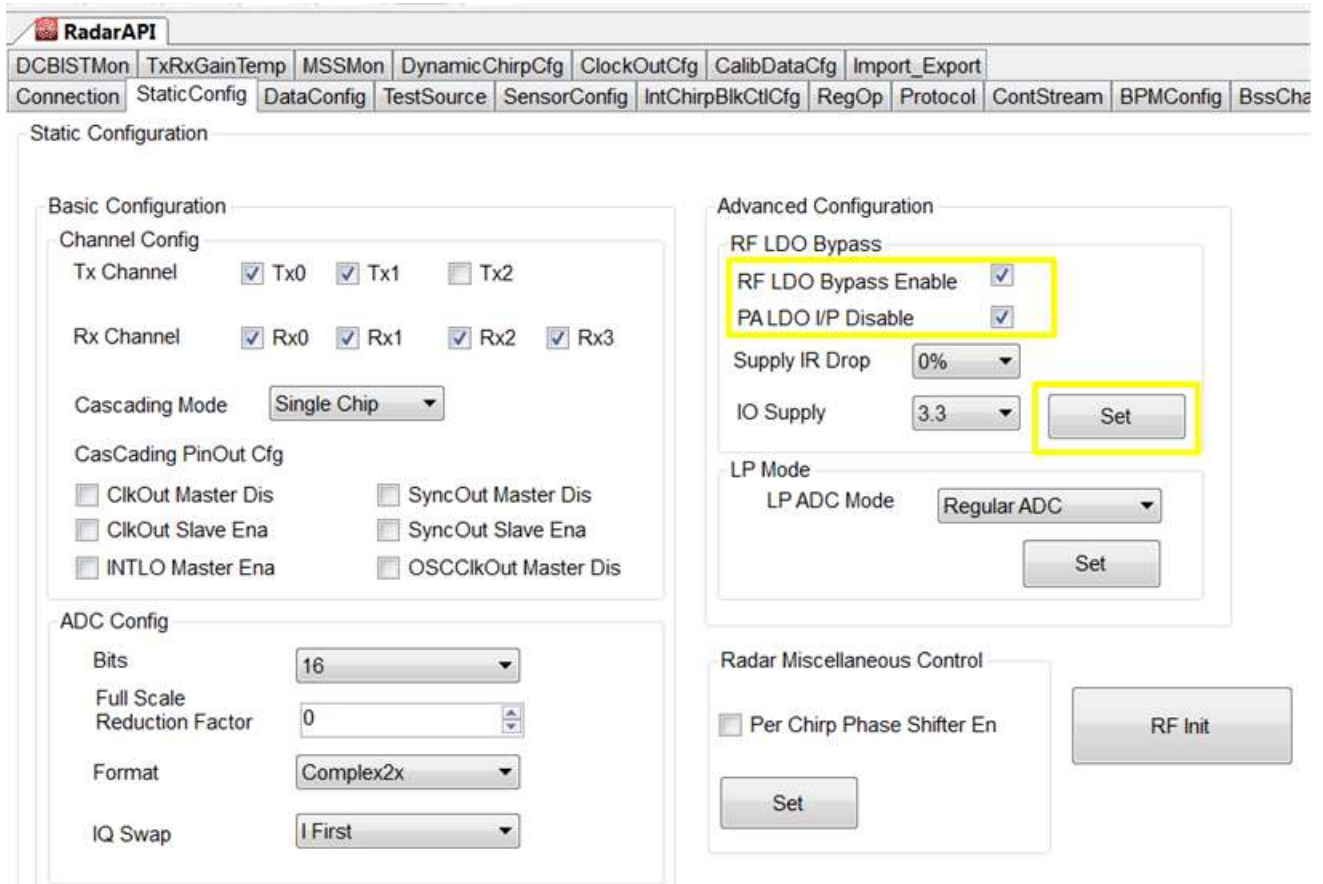

Figure 22. LDO Bypass Enable

### 3.2.2 Power Supply Optimization

For best transient supply settling at the start of the chirp, the [idle time + TX start time] can be set to a value < 10  $\mu$ sec. In this configuration, the AWR firmware keeps some of the RF blocks ON between the chirps. For idle time + Tx start time > 10  $\mu$ sec, the blocks are turned off for power saving. In this case, TI recommends adding an additional resistive load on the 1-V LDO oputput; the available R83 pad can be used for this purpose. The value of the resistance can be between 10 to 30  $\Omega$ , depending on the idle time setting. The other option is to disable the inter-chirp power save feature of the AWR device using the AWR DYNAMICPOWERSAVE CONF SET SB API.

The LC filter on the 1-V and 1.8-V supplies is used to filter the 4-Mhz ripple from the switcher. There could be small ringing behavior at the point of transient load change. If this is impacting the RX sampled data, the ADC start time can be increased to a point where the supply is settled within 5%, or the inductance value can be reduced to reduce the ringing (which may come at the expense or poorer 4-Mhz filtering).

## 4 Design Revision History

**Table 6. Design Revision History**

PCB Revision	Change Description
Rev C	Increased LDO output cap to 47 $\mu$ F
	Added two optional 100- $\mu$ F LDO output caps
	Added 10- $\mu$ F cap to LDO output
	Added test pad to LDO PG pin
	Connected LDO DNC pads to GND for thermal performance
	Added optional bleeed resistor on LDO output
	Changed 1-V filtering to BLM18 inductor
	Added 22- $\mu$ F caps to 1-V, 1.24-C, and 1.8-V LC filters
	Added 10- $\mu$ F cpas to 3.3-V and 1.24-V LC filters
	Added additional 10- $\mu$ F caps to 1-V LC fitlers

## 5 Mechanical Mounting of PCB

The field of view of the radar sensor is orthogonal to the PCB. To enable easy measurements on the sensing objects on the horizontal plane, the PCB can be mounted vertically. The L-brackets provided with the xWR1843 EVM kit, along with the screws and nuts help in the vertical mounting of the EVM. [Figure 23](#) shows how the L-brackets can be assembled.



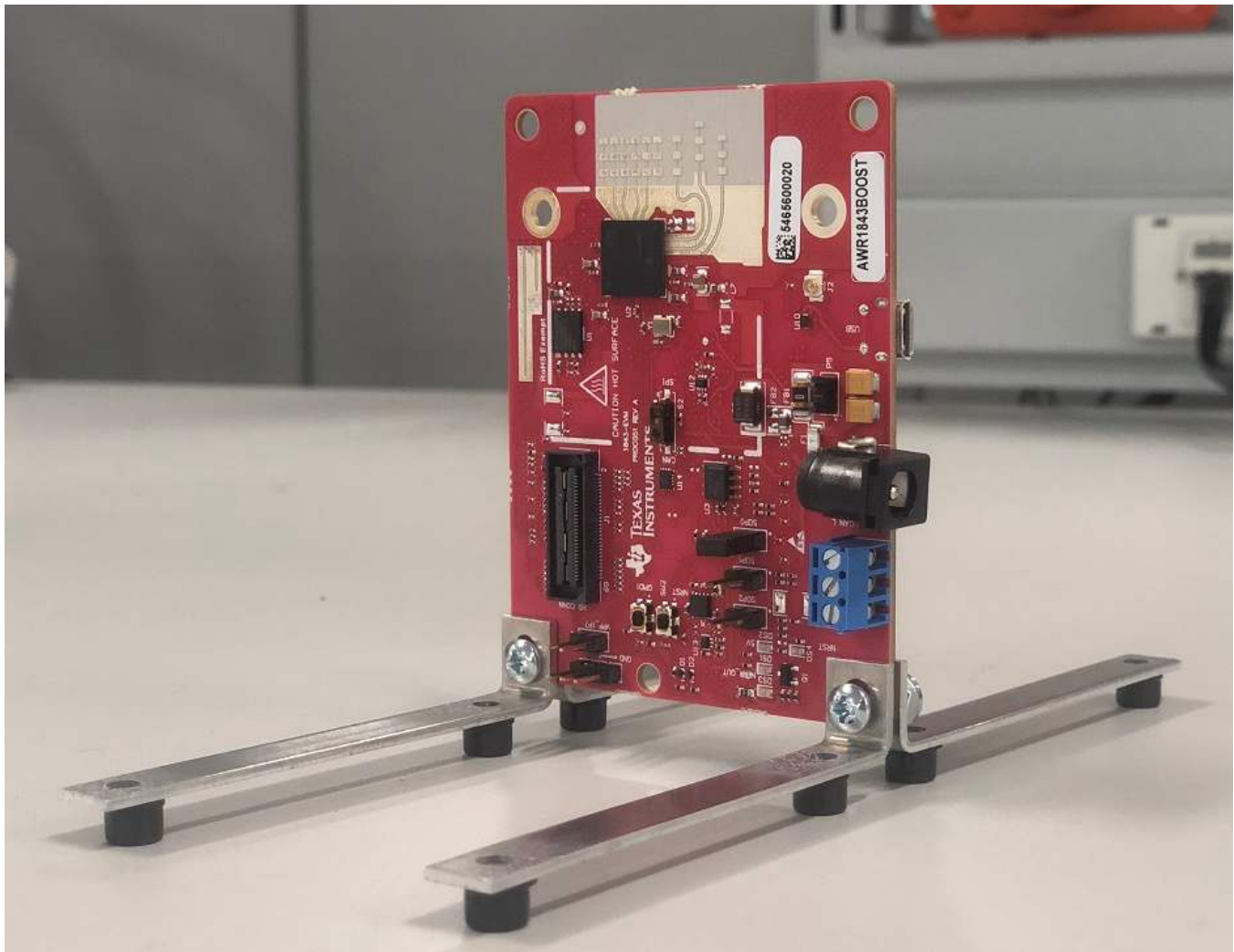

**Figure 23. Vertical Assembly of the EVM**

## 6 PCB Storage and Handling Recommendations

The immersion silver finish of the PCB provides a better high-frequency performance, but is also prone to oxidation in open environments. This oxidation causes the surface around the antenna region to blacken. To avoid oxidation, the PCB should be stored in an ESD cover and kept at a controlled room temperature with low humidity conditions. All ESD precautions must be taken while using and handling the EVM.

## 7 Troubleshooting

### EVM Board Power-up Failure

See [Section 2.2](#) for desired power connections. Please ensure NRST and PWR LEDs glow brightly. When a nonfunctional or insufficient current capacity power supply is used with the EVM, the EVM LEDs will not turn on. See [Section 2.8.3](#) for LED information.

## 8 References

[DCA1000EVM Data Capture Card User's Guide](#)

---

## Revision History

NOTE: Page numbers for previous revisions may differ from page numbers in the current version.

<b>Changes from A Revision (August 2019) to B Revision</b>	<b>Page</b>
• Added Note. ....	16

---

## IMPORTANT NOTICE AND DISCLAIMER

TI PROVIDES TECHNICAL AND RELIABILITY DATA (INCLUDING DATASHEETS), DESIGN RESOURCES (INCLUDING REFERENCE DESIGNS), APPLICATION OR OTHER DESIGN ADVICE, WEB TOOLS, SAFETY INFORMATION, AND OTHER RESOURCES "AS IS" AND WITH ALL FAULTS, AND DISCLAIMS ALL WARRANTIES, EXPRESS AND IMPLIED, INCLUDING WITHOUT LIMITATION ANY IMPLIED WARRANTIES OF MERCHANTABILITY, FITNESS FOR A PARTICULAR PURPOSE OR NON-INFRINGEMENT OF THIRD PARTY INTELLECTUAL PROPERTY RIGHTS.

These resources are intended for skilled developers designing with TI products. You are solely responsible for (1) selecting the appropriate TI products for your application, (2) designing, validating and testing your application, and (3) ensuring your application meets applicable standards, and any other safety, security, or other requirements. These resources are subject to change without notice. TI grants you permission to use these resources only for development of an application that uses the TI products described in the resource. Other reproduction and display of these resources is prohibited. No license is granted to any other TI intellectual property right or to any third party intellectual property right. TI disclaims responsibility for, and you will fully indemnify TI and its representatives against, any claims, damages, costs, losses, and liabilities arising out of your use of these resources.

TI's products are provided subject to TI's Terms of Sale ([www.ti.com/legal/termsofsale.html](http://www.ti.com/legal/termsofsale.html)) or other applicable terms available either on [ti.com](http://ti.com) or provided in conjunction with such TI products. TI's provision of these resources does not expand or otherwise alter TI's applicable warranties or warranty disclaimers for TI products.

Mailing Address: Texas Instruments, Post Office Box 655303, Dallas, Texas 75265  
Copyright © 2020, Texas Instruments Incorporated