

EVALUATION KIT  
AVAILABLE**MAXIM****Dual, 10-Bit, 80Msps, Current-Output DAC****General Description**

The MAX5853 dual, 10-bit, 80Msps digital-to-analog converter (DAC) provides superior dynamic performance in wideband communication systems. The device integrates two 10-bit DAC cores, and a 1.24V reference. The converter supports single-ended and differential modes of operation. The MAX5853 dynamic performance is maintained over the entire 2.7V to 3.6V power-supply operating range. The analog outputs support a -1.0V to +1.25V compliance voltage.

The MAX5853 can also operate in interleave data mode to reduce the I/O pin count. This allows the converter to be updated on a single, 10-bit bus.

The MAX5853 features digital control of channel gain matching to within  $\pm 0.4\text{dB}$  in sixteen 0.05dB steps. Channel matching improves sideband suppression in analog quadrature modulation applications. The on-chip 1.24V bandgap reference includes a control amplifier that allows external full-scale adjustments of both channels through a single resistor. The internal reference can be disabled and an external reference may be applied for high-accuracy applications.

The MAX5853 features full-scale current outputs of 2mA to 20mA and operates from a 2.7V to 3.6V single supply. The DAC supports three modes of power-control operation: normal, low-power standby, and complete power-down. In power-down mode, the operating current is reduced to 1 $\mu\text{A}$ .

The MAX5853 is packaged in a 40-pin thin QFN with exposed paddle (EP) and is specified for the extended (-40°C to +85°C) temperature range.

Pin-compatible, higher speed, and lower resolution versions are also available. Refer to the MAX5854 (10-bit, 165Msps), the MAX5852\*\* (8-bit, 165Msps), and the MAX5851\*\* (8-bit, 80Msps) data sheets for more information. See Table 4 at the end of the data sheet.

**Applications**

Communications  
SatCom, LMDS, MMDS, HFC, DSL, WLAN,  
Point-to-Point Microwave Links

Wireless Base Stations

Quadrature Modulation

Direct Digital Synthesis (DDS)

Instrumentation/ATE

\*\*Future product—contact factory for availability.

**Features**

- ◆ 10-Bit, 80Msps Dual DAC
- ◆ Low Power  
77mW with  $I_{FS} = 5\text{mA}$  at  $f_{CLK} = 80\text{MHz}$
- ◆ 2.7V to 3.6V Single Supply
- ◆ Full Output Swing and Dynamic Performance at 2.7V Supply
- ◆ Superior Dynamic Performance  
78dBc SFDR at  $f_{OUT} = 20\text{MHz}$
- ◆ Programmable Channel Gain Matching
- ◆ Integrated 1.24V Low-Noise Bandgap Reference
- ◆ Single-Resistor Gain Control
- ◆ Interleaved Data Mode
- ◆ Single-Ended and Differential Clock Input Modes
- ◆ Miniature 40-Pin Thin QFN Package, 6mm x 6mm
- ◆ EV Kit Available—MAX5854 EV Kit

**Ordering Information**

PART	TEMP RANGE	PIN-PACKAGE
MAX5853ETL	-40°C to +85°C	40 Thin QFN-EP*

\*EP = Exposed paddle.

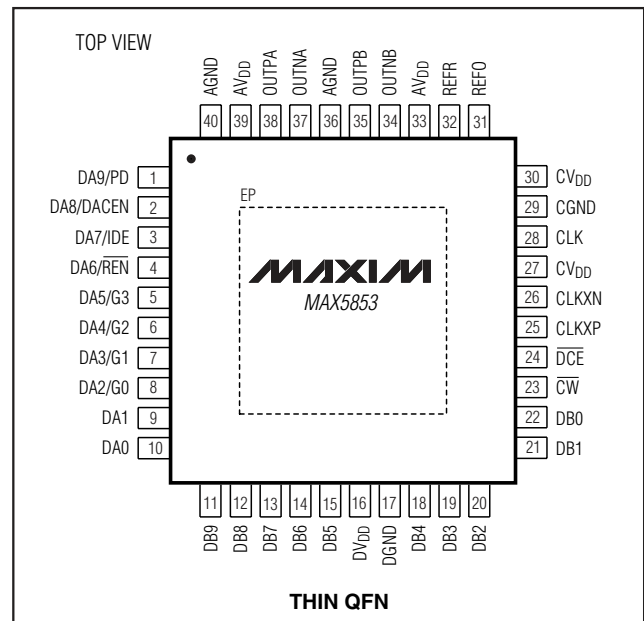
**Pin Configuration****MAXIM**

Maxim Integrated Products 1

**For pricing, delivery, and ordering information, please contact Maxim/Dallas Direct! at 1-888-629-4642, or visit Maxim's website at [www.maxim-ic.com](http://www.maxim-ic.com).**

**MAX5853**

# Dual, 10-Bit, 80MSPS, Current-Output DAC

## ABSOLUTE MAXIMUM RATINGS

AV <sub>DD</sub> to AGND .....	-0.3V to +4V	OUTPA, OUTNA to AGND .....	(AV <sub>DD</sub> - 4.8V) to (AV <sub>DD</sub> + 0.3V)
DV <sub>DD</sub> to DGND .....	-0.3V to +4V	OUTPB, OUTNB to AGND .....	(AV <sub>DD</sub> - 4.8V) to (AV <sub>DD</sub> + 0.3V)
CV <sub>DD</sub> to CGND .....	-0.3V to +4V	Maximum Current into Any Pin	
AV <sub>DD</sub> to DV <sub>DD</sub> .....	-4V to +4V	(excluding power supplies) .....	±50mA
AGND to DGND .....	-0.3V to +0.3V	Continuous Power Dissipation (T <sub>A</sub> = +70°C)	
AGND to CGND .....	-0.3V to +0.3V	40-Pin Thin QFN (derate 26.3mW/°C above +70°C) .....	2105mW
DGND to CGND .....	-0.3V to +0.3V	Operating Temperature Range .....	-40°C to +85°C
DA9–DA0, DB9–DB0, CW, DCE to DGND .....	-0.3V to +4V	Storage Temperature Range .....	-65°C to +150°C
CLK to CGND .....	-0.3V to (CV <sub>DD</sub> + 0.3V)	Junction Temperature .....	+150°C
CLKXN, CLKXP to CGND .....	-0.3V to +4V	Lead Temperature (soldering, 10s) .....	+300°C
REFR, REFO to AGND .....	-0.3V to (AV <sub>DD</sub> + 0.3V)		

Stresses beyond those listed under "Absolute Maximum Ratings" may cause permanent damage to the device. These are stress ratings only, and functional operation of the device at these or any other conditions beyond those indicated in the operational sections of the specifications is not implied. Exposure to absolute maximum rating conditions for extended periods may affect device reliability.

## ELECTRICAL CHARACTERISTICS

(AV<sub>DD</sub> = DV<sub>DD</sub> = CV<sub>DD</sub> = 3V, AGND = DGND = CGND = 0, f<sub>DAC</sub> = 80MSPS, differential clock, external reference, V<sub>REF</sub> = 1.2V, I<sub>FS</sub> = 20mA, differential output, output amplitude = 0dBFS, T<sub>A</sub> = T<sub>MIN</sub> to T<sub>MAX</sub>, unless otherwise noted. T<sub>A</sub> ≥ +25°C, guaranteed by production test. T<sub>A</sub> < +25°C guaranteed by design and characterization. Typical values are at T<sub>A</sub> = +25°C.)

PARAMETER	SYMBOL	CONDITIONS	MIN	TYP	MAX	UNITS
<b>STATIC PERFORMANCE</b>						
Resolution	N		10			Bits
Integral Nonlinearity	INL	R <sub>L</sub> = 0	-1.0	±0.25	+1.0	LSB
Differential Nonlinearity	DNL	Guaranteed monotonic, R <sub>L</sub> = 0	-0.5	±0.2	+0.5	LSB
Offset Error	V <sub>OS</sub>		-0.5	±0.1	+0.5	LSB
Gain Error (See Also <i>Gain Error Definition</i> Section)	GE	Internal reference (Note1)	-11.0	±1.5	+6.8	%FSR
		External reference	-6.25	±0.7	+4.10	
Gain-Error Temperature Drift		Internal reference		±150		ppm/°C
		External reference		±100		
<b>DYNAMIC PERFORMANCE</b>						
Spurious-Free Dynamic Range to Nyquist	SFDR	f <sub>CLK</sub> = 80MHz, A <sub>OUT</sub> = -1dBFS	f <sub>OUT</sub> = 10MHz	69.5	78	dBc
			f <sub>OUT</sub> = 20MHz		78	
			f <sub>OUT</sub> = 30MHz		72	
		f <sub>CLK</sub> = 44MHz, A <sub>OUT</sub> = -1dBFS	f <sub>OUT</sub> = 10MHz		78	
		f <sub>CLK</sub> = 25MHz, A <sub>OUT</sub> = -1dBFS	f <sub>OUT</sub> = 1MHz		79	
Spurious-Free Dynamic Range Within a Window	SFDR	f <sub>CLK</sub> = 80MHz, f <sub>OUT</sub> = 10MHz, A <sub>OUT</sub> = -1dBFS, span = 10MHz			85	dBc
		f <sub>CLK</sub> = 65MHz, f <sub>OUT</sub> = 5MHz, A <sub>OUT</sub> = -1dBFS, span = 2.5MHz			82	
		f <sub>CLK</sub> = 25MHz, f <sub>OUT</sub> = 1MHz, A <sub>OUT</sub> = -1dBFS, span = 2MHz			82	
Multitone Power Ratio to Nyquist	MTPR	8 tones at 400kHz spacing, f <sub>CLK</sub> = 78MHz, f <sub>OUT</sub> = 15MHz to 18.2MHz			74	dBc

# Dual, 10-Bit, 80Mps, Current-Output DAC

MAX5853

## ELECTRICAL CHARACTERISTICS (continued)

( $V_{DD} = DV_{DD} = CV_{DD} = 3V$ ,  $AGND = DGND = CGND = 0$ ,  $f_{DAC} = 80Mps$ , differential clock, external reference,  $V_{REF} = 1.2V$ ,  $I_{FS} = 20mA$ , differential output, output amplitude = 0dBFS,  $T_A = T_{MIN}$  to  $T_{MAX}$ , unless otherwise noted.  $T_A \geq +25^\circ C$ , guaranteed by production test.  $T_A < +25^\circ C$  guaranteed by design and characterization. Typical values are at  $T_A = +25^\circ C$ .)

PARAMETER	SYMBOL	CONDITIONS	MIN	TYP	MAX	UNITS
Multitone Spurious-Free Dynamic Range Within a Window		8 tones at 811kHz spacing, $f_{CLK} = 80MHz$ , $f_{OUT} = 10.8MHz$ to $17.2MHz$ , span = 15MHz		76		dBc
Total Harmonic Distortion to Nyquist (2nd- Through 8th-Order Harmonics Included)	THD	$f_{CLK} = 80MHz$ , $A_{OUT} = -1dBFS$	$f_{OUT} = 10MHz$	-76		dBc
			$f_{OUT} = 20MHz$	-75		
			$f_{OUT} = 30MHz$	-70		
		$f_{CLK} = 44MHz$ , $A_{OUT} = -1dBFS$	$f_{OUT} = 10MHz$	-76		
		$f_{CLK} = 25MHz$ , $A_{OUT} = -1dBFS$	$f_{OUT} = 1MHz$	-76		
Output Channel-to-Channel Isolation		$f_{OUT} = 10MHz$		90		dB
Channel-to-Channel Gain Mismatch		$f_{OUT} = 10MHz$ , $G[3:0] = 1000$		0.025		dB
Channel-to-Channel Phase Mismatch		$f_{OUT} = 10MHz$		0.05		Degrees
Signal-to-Noise Ratio to Nyquist	SNR	$f_{CLK} = 80MHz$ , $f_{OUT} = 5MHz$ , $I_{FS} = 20mA$		62		dB
		$f_{CLK} = 80MHz$ , $f_{OUT} = 5MHz$ , $I_{FS} = 5mA$		62		
Maximum DAC Conversion Rate	$f_{DAC}$	Interleaved mode disabled, $IDE = 0$	80			Mps
		Interleaved mode enabled, $IDE = 1$	80			
Glitch Impulse				5		pV-s
Output Settling Time	$t_S$	To $\pm 0.1\%$ error band (Note 3)		12		ns
Output Rise Time		10% to 90% (Note 3)		2.2		ns
Output Fall Time		90% to 10% (Note 3)		2.2		ns
<b>ANALOG OUTPUT</b>						
Full-Scale Output Current Range	$I_{FS}$		2		20	mA
Output Voltage Compliance Range			-1.00		+1.25	V
Output Leakage Current		Shutdown or standby mode	-5		+5	$\mu A$
<b>REFERENCE</b>						
Internal-Reference Output Voltage	$V_{REF0}$	$\overline{REN} = 0$	1.13	1.24	1.32	V
Internal-Reference Supply Rejection		$AV_{DD}$ varied from 2.7V to 3.6V		0.5		mV/V
Internal-Reference Output-Voltage Temperature Drift	$TCV_{REF0}$	$\overline{REN} = 0$		$\pm 50$		ppm/ $^\circ C$

# Dual, 10-Bit, 80Msps, Current-Output DAC

## ELECTRICAL CHARACTERISTICS (continued)

(AVDD = DVDD = CVDD = 3V, AGND = DGND = CGND = 0, fDAC = 80Msps, differential clock, external reference, VREF = 1.2V, IFS = 20mA, differential output, output amplitude = 0dBFS, TA = TMIN to TMAX, unless otherwise noted. TA ≥ +25°C, guaranteed by production test. TA < +25°C guaranteed by design and characterization. Typical values are at TA = +25°C.)

PARAMETER	SYMBOL	CONDITIONS	MIN	TYP	MAX	UNITS
Internal-Reference Output Drive Capability		$\overline{REN} = 0$		50		μA
External-Reference Input Voltage Range		$\overline{REN} = 1$	0.10	1.2	1.32	V
Current Gain	I <sub>FS</sub> /I <sub>REF</sub>			32		mA/mA
<b>LOGIC INPUTS (DA9–DA0, DB9–DB0, CW)</b>						
Digital Input-Voltage High	V <sub>IH</sub>		0.65 x DVDD			V
Digital Input-Voltage Low	V <sub>IL</sub>				0.3 x DVDD	V
Digital Input Current	I <sub>IN</sub>		-1		+1	μA
Digital Input Capacitance	C <sub>IN</sub>			3		pF
<b>SINGLE-ENDED CLOCK INPUT/OUTPUT AND DCE INPUT (CLK, DCE)</b>						
Digital Input-Voltage High	V <sub>IH</sub>	$\overline{DCE} = 1$	0.65 x CVDD			V
Digital Input-Voltage Low	V <sub>IL</sub>	$\overline{DCE} = 1$			0.3 x CVDD	V
Digital Input Current	I <sub>IN</sub>	$\overline{DCE} = 1$	-1		+1	μA
Digital Input Capacitance	C <sub>IN</sub>	$\overline{DCE} = 1$		3		pF
Digital Output-Voltage High	V <sub>OH</sub>	$\overline{DCE} = 0$ , I <sub>SOURCE</sub> = 0.5mA, Figure 1	0.9 x CVDD			V
Digital Output-Voltage Low	V <sub>OL</sub>	$\overline{DCE} = 0$ , I <sub>SINK</sub> = 0.5mA, Figure 1			0.1 x CVDD	V
<b>DIFFERENTIAL CLOCK INPUTS (CLKXP/CLKXN)</b>						
Differential Clock Input Internal Bias				CVDD / 2		V
Differential Clock Input Swing			0.5			V
Clock Input Impedance		Measured single ended		5		kΩ
<b>POWER REQUIREMENTS</b>						
Analog Power-Supply Voltage	AVDD		2.7	3	3.6	V
Digital Power-Supply Voltage	DVDD		2.7	3	3.6	V
Clock Power-Supply Voltage	CVDD		2.7	3	3.6	V
Analog Supply Current	IAVDD	I <sub>FS</sub> = 20mA (Note 2), single-ended clock mode		43.2	46	mA
		I <sub>FS</sub> = 20mA (Note 2), differential clock mode		43.2		
		I <sub>FS</sub> = 2mA (Note 2), single-ended clock mode		5		
		I <sub>FS</sub> = 2mA (Note 2), differential clock mode		5		

# Dual, 10-Bit, 80MSPS, Current-Output DAC

MAX5853

## ELECTRICAL CHARACTERISTICS (continued)

( $V_{DD} = DV_{DD} = CV_{DD} = 3V$ ,  $AGND = DGND = CGND = 0$ ,  $f_{DAC} = 80MSPS$ , differential clock, external reference,  $V_{REF} = 1.2V$ ,  $I_{FS} = 20mA$ , differential output, output amplitude = 0dBFS,  $T_A = T_{MIN}$  to  $T_{MAX}$ , unless otherwise noted.  $T_A \geq +25^\circ C$ , guaranteed by production test.  $T_A < +25^\circ C$  guaranteed by design and characterization. Typical values are at  $T_A = +25^\circ C$ .)

PARAMETER	SYMBOL	CONDITIONS	MIN	TYP	MAX	UNITS
Digital Supply Current	I <sub>DVDD</sub>	I <sub>FS</sub> = 20mA (Note 2), single-ended clock mode		3.4	4	mA
		I <sub>FS</sub> = 20mA (Note 2), differential clock mode		3.4		
Clock Supply Current	I <sub>CVDD</sub>	Single-ended clock mode ( $\overline{DCE} = 1$ ) (Note 2)		11.1	13.5	mA
		Differential clock mode ( $\overline{DCE} = 0$ ) (Note 2)		16.7		
Total Standby Current	I <sub>STANDBY</sub>	I <sub>AVDD</sub> + I <sub>DVDD</sub> + I <sub>CVDD</sub>		3.1	3.7	mA
Total Shutdown Current	I <sub>SHDN</sub>	I <sub>AVDD</sub> + I <sub>DVDD</sub> + I <sub>CVDD</sub>		1		μA
Total Power Dissipation	P <sub>TOT</sub>	Single-ended clock mode ( $\overline{DCE} = 1$ )	I <sub>FS</sub> = 20mA (Note 2)	173	191	mW
			I <sub>FS</sub> = 2mA (Note 2)	58		
		Differential clock mode ( $\overline{DCE} = 0$ )	I <sub>FS</sub> = 20mA (Note 2)	190		
			I <sub>FS</sub> = 2mA (Note 2)	75		
		Standby		9.3	11.1	
Shutdown		0.003				
<b>TIMING CHARACTERISTICS</b> (Figures 5 and 6)						
Propagation Delay				1		Clock cycles
DAC Data to CLK Rise/Fall Setup Time	t <sub>DCS</sub>	Single-ended clock mode ( $\overline{DCE} = 1$ ) (Note 4)	1.2			ns
		Differential clock mode ( $\overline{DCE} = 0$ ) (Note 4)	2.7			
DAC Data to CLK Rise/Fall Hold Time	t <sub>DCH</sub>	Single-ended clock mode ( $\overline{DCE} = 1$ ) (Note 4)	0.8			ns
		Differential clock mode ( $\overline{DCE} = 0$ ) (Note 4)	-0.5			
Control Word to $\overline{CW}$ Rise Setup Time	t <sub>CS</sub>		2.5			ns
Control Word to $\overline{CW}$ Rise Hold Time	t <sub>CW</sub>		2.5			ns
$\overline{CW}$ High Time	t <sub>CWH</sub>		5			ns
$\overline{CW}$ Low Time	t <sub>CWL</sub>		5			ns

# Dual, 10-Bit, 80Mps, Current-Output DAC

## ELECTRICAL CHARACTERISTICS (continued)

( $V_{DD} = DV_{DD} = CV_{DD} = 3V$ ,  $AGND = DGND = CGND = 0$ ,  $f_{DAC} = 80\text{Mps}$ , differential clock, external reference,  $V_{REF} = 1.2V$ ,  $I_{FS} = 20\text{mA}$ , differential output, output amplitude =  $0\text{dBFS}$ ,  $T_A = T_{MIN}$  to  $T_{MAX}$ , unless otherwise noted.  $T_A \geq +25^\circ\text{C}$ , guaranteed by production test.  $T_A < +25^\circ\text{C}$  guaranteed by design and characterization. Typical values are at  $T_A = +25^\circ\text{C}$ .)

PARAMETER	SYMBOL	CONDITIONS	MIN	TYP	MAX	UNITS
DACEN = 1 to $V_{OUT}$ Stable Time (Coming Out of Standby)	$t_{STB}$			3		$\mu\text{s}$
PD = 0 to $V_{OUT}$ Stable Time (Coming Out of Power-Down)	$t_{SHDN}$			500		$\mu\text{s}$
Maximum Clock Frequency at CLKXP/CLKXN Input	$f_{CLK}$		80			MHz
Clock High Time	$t_{CXH}$	CLKXP or CLKXN input		3		ns
Clock Low Time	$t_{CXL}$	CLKXP or CLKXN input		3		ns
CLKXP Rise to CLK Output Rise Delay	$t_{CDH}$	$\overline{DCE} = 0$		2.7		ns
CLKXP Fall to CLK Output Fall Delay	$t_{CDL}$	$\overline{DCE} = 0$		2.7		ns

**Note 1:** Including the internal reference voltage tolerance and reference amplifier offset.

**Note 2:**  $f_{DAC} = 80\text{Mps}$ ,  $f_{OUT} = 10\text{MHz}$ .

**Note 3:** Measured single ended with  $50\Omega$  load and complementary output connected to ground.

**Note 4:** Guaranteed by design, not production tested.

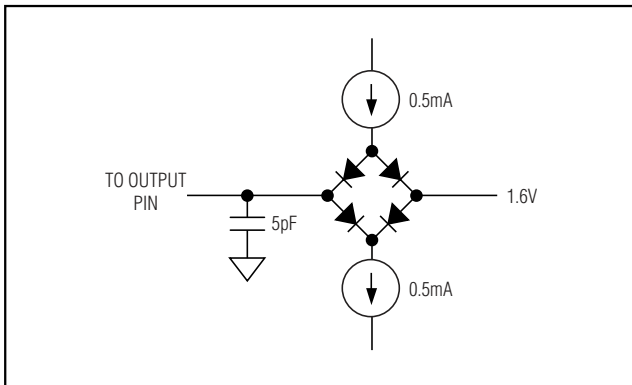

Figure 1. Load Test Circuit for CLK Outputs

# Dual, 10-Bit, 80Mps, Current-Output DAC

MAX5853

## Typical Operating Characteristics

( $AV_{DD} = DV_{DD} = CV_{DD} = 3V$ ,  $AGND = DGND = CGND = 0$ , external reference,  $I_{FS} = 20mA$ , differential output, differential clock (unless otherwise noted),  $T_A = +25^{\circ}C$ .)

**SPURIOUS-FREE DYNAMIC RANGE vs. OUTPUT FREQUENCY ( $f_{CLK} = 80MHz$ )**

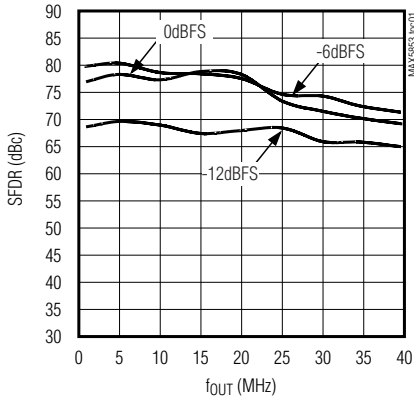

**SPURIOUS-FREE DYNAMIC RANGE vs. OUTPUT FREQUENCY ( $f_{CLK} = 44MHz$ )**

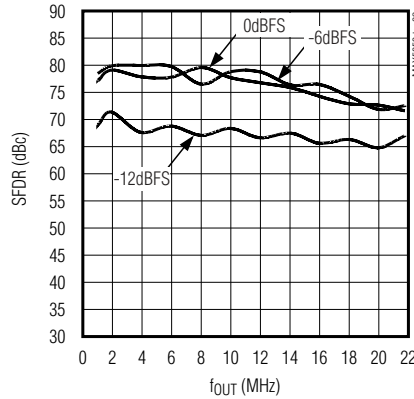

**SPURIOUS-FREE DYNAMIC RANGE vs. OUTPUT FREQUENCY ( $f_{CLK} = 25MHz$ )**

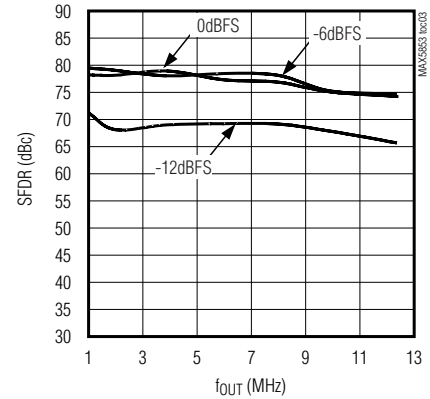

**SPURIOUS-FREE DYNAMIC RANGE vs. OUTPUT FREQUENCY ( $f_{CLK} = 65MHz$ )**

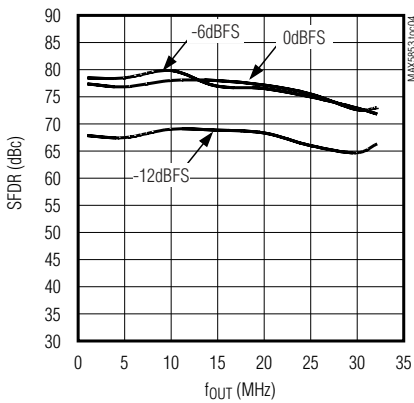

**SPURIOUS-FREE DYNAMIC RANGE vs. OUTPUT FREQUENCY ( $f_{CLK} = 80MHz$ )**

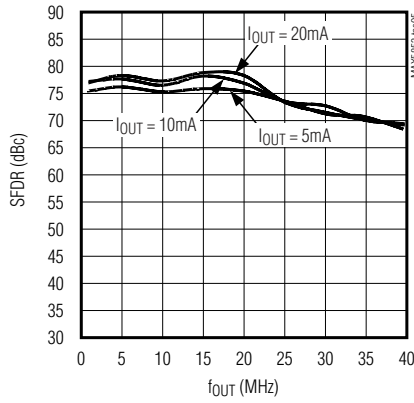

**SPURIOUS-FREE DYNAMIC RANGE vs. OUTPUT FREQUENCY ( $f_{CLK} = 80MHz$ )**

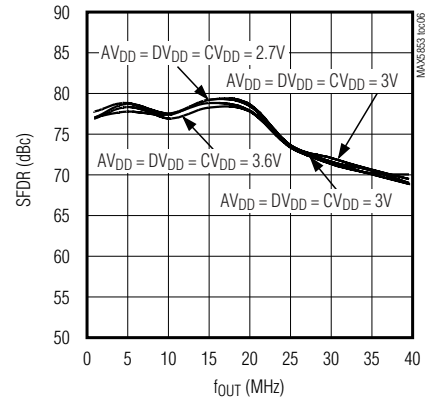

**SPURIOUS-FREE DYNAMIC RANGE vs. TEMPERATURE ( $f_{CLK} = 80MHz$ ,  $f_{OUT} = 10MHz$ ,  $A_{OUT} = 0dBFS$ )**

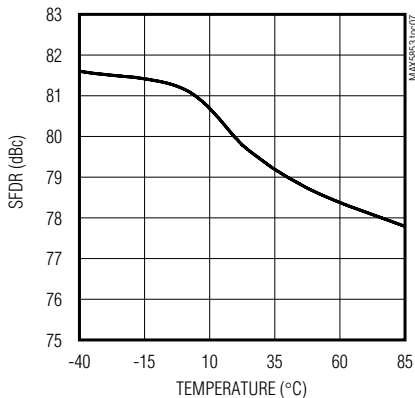

**TWO-TONE INTERMODULATION DISTORTION ( $f_{CLK} = 80MHz$ , 8MHz WINDOW)**

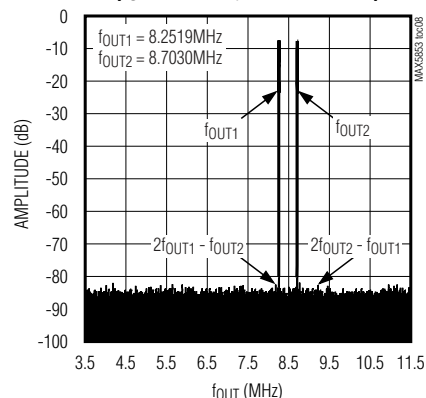

# Dual, 10-Bit, 80Mps, Current-Output DAC

## Typical Operating Characteristics (continued)

( $V_{DD} = DV_{DD} = CV_{DD} = 3V$ ,  $AGND = DGND = CGND = 0$ , external reference,  $I_{FS} = 20mA$ , differential output, differential clock (unless otherwise noted),  $T_A = +25^{\circ}C$ .)

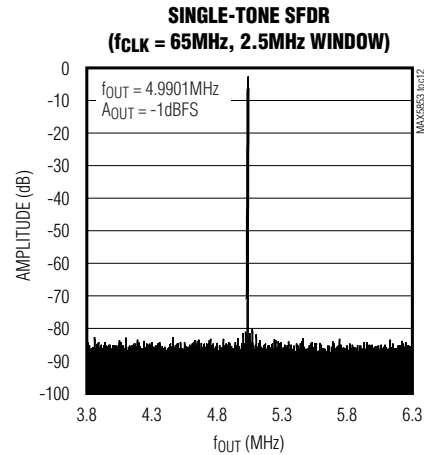
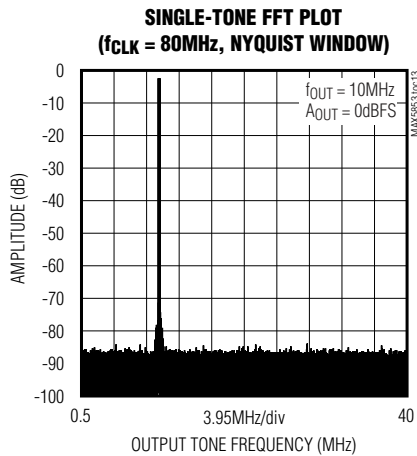
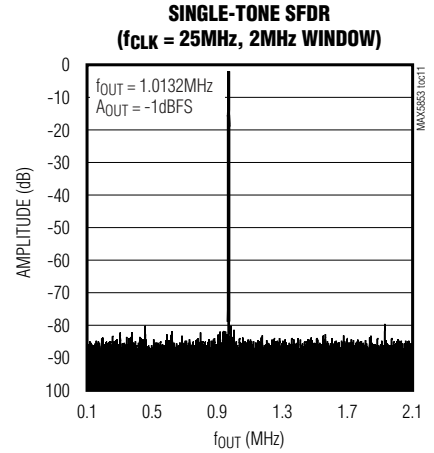
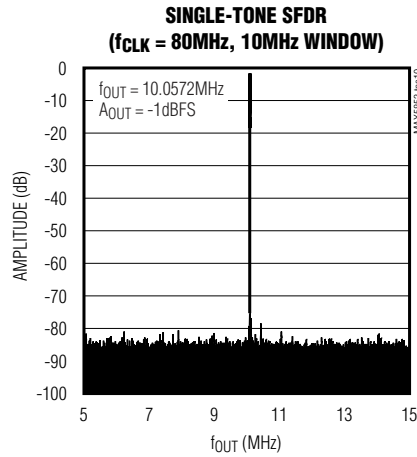
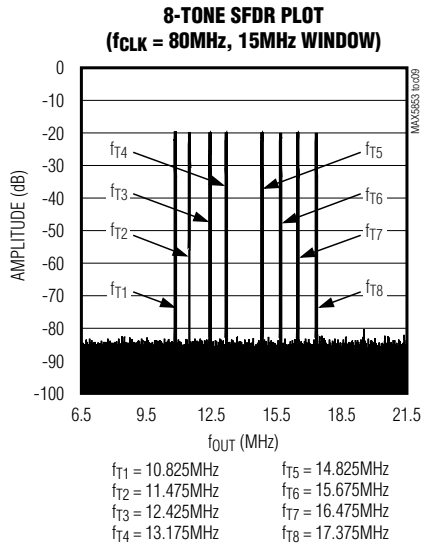



# Dual, 10-Bit, 80Mps, Current-Output DAC

MAX5853

## Typical Operating Characteristics (continued)

( $V_{DD} = DV_{DD} = CV_{DD} = 3V$ ,  $AGND = DGND = CGND = 0$ , external reference,  $I_{FS} = 20mA$ , differential output, differential clock (unless otherwise noted),  $T_A = +25^\circ C$ .)

**INTEGRAL NONLINEARITY vs. DIGITAL INPUT CODE**

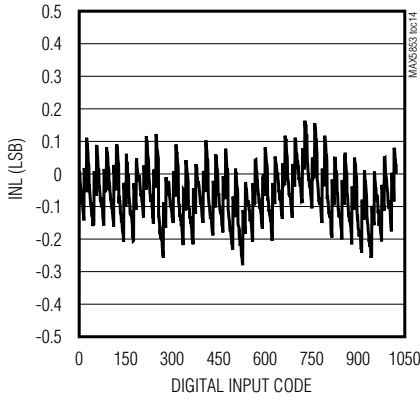

**DIFFERENTIAL NONLINEARITY vs. DIGITAL INPUT CODE**

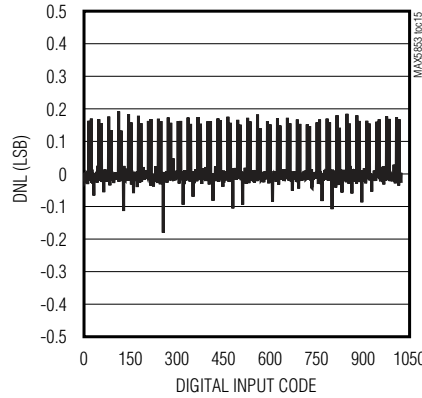

**POWER DISSIPATION vs. CLOCK FREQUENCY**  
( $f_{OUT} = 10MHz$ ,  $A_{OUT} = 0dBFS$ )

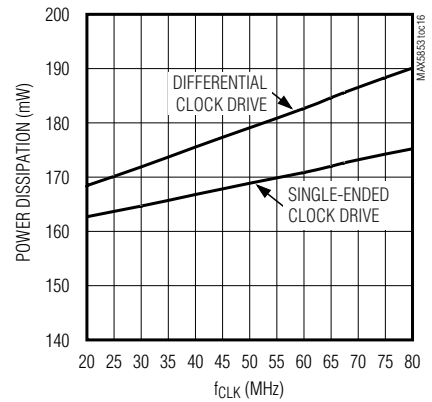

**POWER DISSIPATION vs. SUPPLY VOLTAGES**  
( $f_{CLK} = 80MHz$ ,  $f_{OUT} = 10MHz$ )

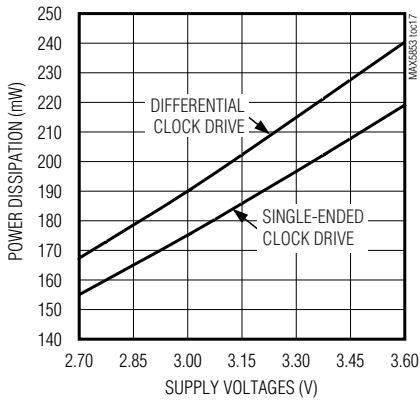

**REFERENCE VOLTAGE vs. SUPPLY VOLTAGES**  
( $f_{CLK} = 80MHz$ ,  $f_{OUT} = 10MHz$ )

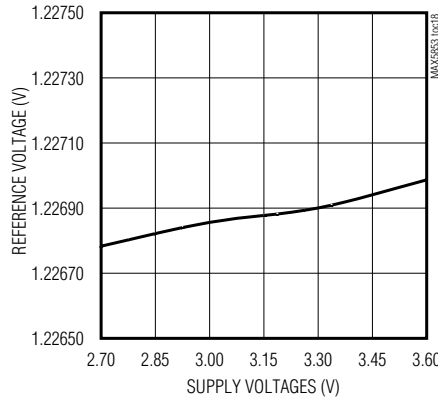

**REFERENCE VOLTAGE vs. TEMPERATURE**

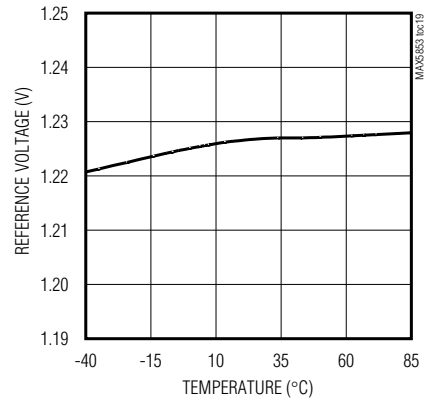

**DYNAMIC RESPONSE RISE TIME**

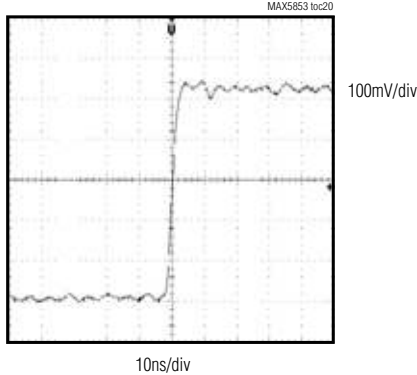

**DYNAMIC RESPONSE FALL TIME**

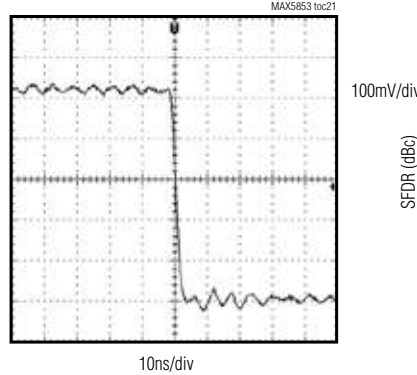

**SPURIOUS-FREE DYNAMIC RANGE vs. OUTPUT FREQUENCY**  
( $f_{CLK} = 80MHz$ )

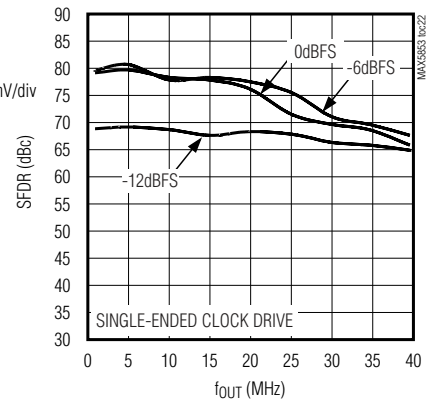

# Dual, 10-Bit, 80MSPS, Current-Output DAC

## Pin Description

PIN	NAME	FUNCTION
1	DA9/PD	Channel A Input Data Bit 9 (MSB)/Power-Down
2	DA8/DACEN	Channel A Input Data Bit 8/DAC Enable Control
3	DA7/IDE	Channel A Input Data Bit 7/Interleaved Data Enable
4	DA6/ $\overline{\text{REN}}$	Channel A Input Data Bit 6/Reference Enable. Setting $\overline{\text{REN}} = 0$ enables the internal reference. Setting $\overline{\text{REN}} = 1$ disables the internal reference.
5	DA5/G3	Channel A Input Data Bit 5/Channel A Gain Adjustment Bit 3
6	DA4/G2	Channel A Input Data Bit 4/Channel A Gain Adjustment Bit 2
7	DA3/G1	Channel A Input Data Bit 3/Channel A Gain Adjustment Bit 1
8	DA2/G0	Channel A Input Data Bit 2/Channel A Gain Adjustment Bit 0
9	DA1	Channel A Input Data Bit 1
10	DA0	Channel A Input Data Bit 0 (LSB)
11	DB9	Channel B Input Data Bit 9 (MSB)
12	DB8	Channel B Input Data Bit 8
13	DB7	Channel B Input Data Bit 7
14	DB6	Channel B Input Data Bit 6
15	DB5	Channel B Input Data Bit 5
16	DV <sub>DD</sub>	Digital Power Input. See the <i>Power Supplies, Bypassing, Decoupling, and Layout</i> section for more details.
17	DGND	Digital Ground
18	DB4	Channel B Input Data Bit 4
19	DB3	Channel B Input Data Bit 3
20	DB2	Channel B Input Data Bit 2
21	DB1	Channel B Input Data Bit 1
22	DB0	Channel B Input Data Bit 0 (LSB)
23	$\overline{\text{CW}}$	Active-Low Control Word Write Pulse. The control word is latched on the rising edge of $\overline{\text{CW}}$ .
24	$\overline{\text{DCE}}$	Active-Low Differential Clock Enable Input. Drive $\overline{\text{DCE}}$ low to enable the differential clock inputs CLKXP and CLKXN. Drive $\overline{\text{DCE}}$ high to disable the differential clock inputs and enable the single-ended CLK input.
25	CLKXP	Positive Differential Clock Input. With $\overline{\text{DCE}} = 0$ , CLKXP and CLKXN are enabled. With $\overline{\text{DCE}} = 1$ , CLKXP and CLKXN are disabled. Connect CLKXP to CGND when the differential clock is disabled.
26	CLKXN	Negative Differential Clock Input. With $\overline{\text{DCE}} = 0$ , CLKXP and CLKXN are enabled. With $\overline{\text{DCE}} = 1$ , CLKXP and CLKXN are disabled. Connect CLKXN to CV <sub>DD</sub> when the differential clock is disabled.
27, 30	CV <sub>DD</sub>	Clock Power Input. See the <i>Power Supplies, Bypassing, Decoupling, and Layout</i> section for more
28	CLK	Single-Ended Clock Input/Output. With the differential clock disabled ( $\overline{\text{DCE}} = 1$ ), CLK becomes a single-ended conversion clock input. With the differential clock enabled ( $\overline{\text{DCE}} = 0$ ), CLK is a single-ended output that mirrors the differential clock inputs CLKXP and CLKXN. See the <i>Clock Modes</i> section for more information on CLK.
29	CGND	Clock Ground
31	REFO	Reference Input/Output. REFO serves as a reference input when the internal reference is disabled. If the internal 1.24V reference is enabled, REFO serves as an output for the internal reference. When the internal reference is enabled, bypass REFO to AGND with a 0.1 $\mu$ F capacitor

# Dual, 10-Bit, 80Mps, Current-Output DAC

**MAX5853**

## Pin Description (continued)

PIN	NAME	FUNCTION
32	REFR	Full-Scale Current Adjustment. To set the output full-scale current, connect an external resistor RSET between REFR and AGND. The output full-scale current is equal to $32 \times V_{REFO}/R_{SET}$ .
33, 39	AV <sub>DD</sub>	Analog Power Input. See the <i>Power Supplies, Bypassing, Decoupling, and Layout</i> section for more details.
34	OUTNB	Channel B Negative Analog Current Output
35	OUTPB	Channel B Positive Analog Current Output
36, 40	AGND	Analog Ground
37	OUTNA	Channel A Negative Analog Current Output
38	OUTPA	Channel A Positive Analog Current Output
—	EP	Exposed Paddle. Connect EP to the common point of all ground planes.

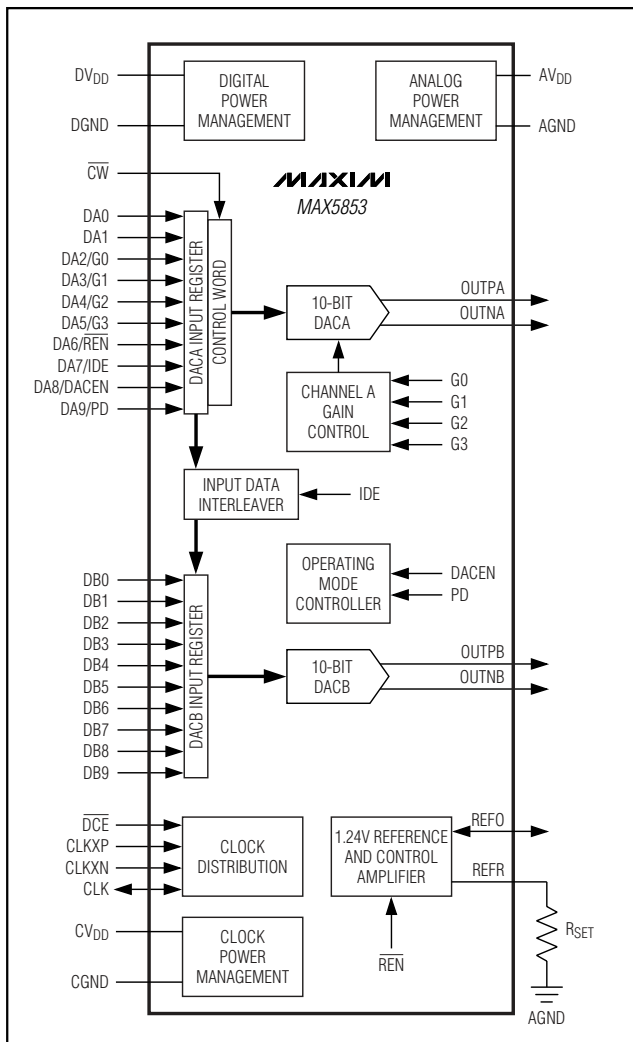

Figure 2. Simplified Diagram

## Detailed Description

The MAX5853 dual, high-speed, 10-bit, current-output DAC provides superior performance in communication systems requiring low-distortion analog-signal reconstruction. The MAX5853 combines two DACs and an on-chip 1.24V reference (Figure 2). The current outputs of the DACs can be configured for differential or single-ended operation. The full-scale output current range is adjustable from 2mA to 20mA to optimize power dissipation and gain control.

The MAX5853 accepts an input data and a DAC conversion rate of 80MHz. The inputs are latched on the rising edge of the clock whereas the output latches on the following rising edge.

The MAX5853 features three modes of operation: normal, standby, and power-down (Table 2). These modes allow efficient power management. In power-down, the MAX5853 consumes only 1µA of supply current. Wake-up time from standby mode to normal DAC operation is 3µs.

### Programming the DAC

An 8-bit control word routed through channel A's data port programs the gain matching, reference, and the operational mode of the MAX5853. The control word is latched on the rising edge of  $\overline{CW}$ .  $\overline{CW}$  is independent of the DAC clock. The DAC clock can always remain running when the control word is written to the DAC. Table 1 and Table 2 represent the control word format and function.

The gain on channel A can be adjusted to achieve gain matching between two channels in a user's system. The gain on channel A can be adjusted from -0.4dB to 0.35dB in steps of 0.05dB by using bits G3 to G0 (see Table 3).

# Dual, 10-Bit, 80MSPS, Current-Output DAC

**Table 1. Control Word Format and Function**

MSB								LSB	
PD	DACEN	IDE	$\overline{\text{REN}}$	G3	G2	G1	G0	X	X
CONTROL WORD	FUNCTION								
PD	Power-Down. The part enters power-down mode if PD = 1.								
DACEN	DAC Enable. When DACEN = 0 and PD = 0, the part enters standby mode.								
IDE	Interleaved Data Mode. IDE = 1 enables the interleaved data mode. In this mode, digital data for both channels is applied through channel A in a multiplexed fashion. Channel B data is written on the falling edge of the clock signal and channel A data is written on the rising edge of the clock signal.								
$\overline{\text{REN}}$	Reference Enable Bit. $\overline{\text{REN}}$ = 0 activates the internal reference. $\overline{\text{REN}}$ = 1 disables the internal reference and requires the user to apply an external reference between 0.1V to 1.32V.								
G3	Bit 3 (MSB) of Gain Adjust Word								
G2	Bit 2 of Gain Adjust Word								
G1	Bit 1 of Gain Adjust Word								
G0	Bit 0 (LSB) of Gain Adjust Word								

**Table 2. Configuration Modes**

MODE	PD	DACEN	IDE	$\overline{\text{REN}}$
Normal operation; noninterleaved inputs; internal reference active	0	1	0	0
Normal operation; noninterleaved inputs; internal reference disabled	0	1	0	1
Normal operation; interleaved inputs; internal reference disabled	0	1	1	1
Standby	0	0	X	X
Power-down	1	X	X	X
Power-up	0	1	X	X

X = Don't care.

**Table 3. Gain Difference Setting**

GAIN ADJUSTMENT ON CHANNEL A (dB)	G3	G2	G1	G0
+0.4	0	0	0	0
0	1	0	0	0
-0.35	1	1	1	1

## Device Power-Up and States of Operation

At power-up, the MAX5853's default configuration is internal reference, noninterleaved input mode with a gain of 0dB and a fully operational converter. In shutdown, the MAX5853 consumes only 1 $\mu$ A of supply current, and in standby the current consumption is 3.1mA. Wake-up time from standby mode to normal operation is 3 $\mu$ s.

## Clock Modes

The MAX5853 allows both single-ended CMOS and differential clock mode operation, and supports update rates of up to 80MSPS. These modes are selected through an active-low control line called  $\overline{\text{DCE}}$ . In single-ended clock mode ( $\overline{\text{DCE}}$  = 1), the CLK pin functions as an input, which accepts a user-provided single-ended clock signal. Data is written to the converter on the rising edge of the clock. The DAC outputs (previous data) are updated simultaneously on the same edge.

If the  $\overline{\text{DCE}}$  pin is pulled low, the MAX5853 operates in differential clock mode. In this mode, the clock signal has to be applied to the differential clock input pins CLKXP/CLKXN. The differential input accepts an input range of  $\geq 0.5\text{V}_{\text{P-P}}$  and a common-mode range of 1V to (CVDD - 0.5V), making the part ideal for low-input amplitude clock drives. CLKXP/CLKXN also help to minimize the jitter, and allow the user to connect a crystal oscillator directly to the MAX5853.

The CLK pin now becomes an output, and provides a single-ended replica of the differential clock signal, which may be used to synchronize the input data. Data is written to the device on the rising edge of the CLK signal.





# Dual, 10-Bit, 80Mps, Current-Output DAC

**MAX5853**

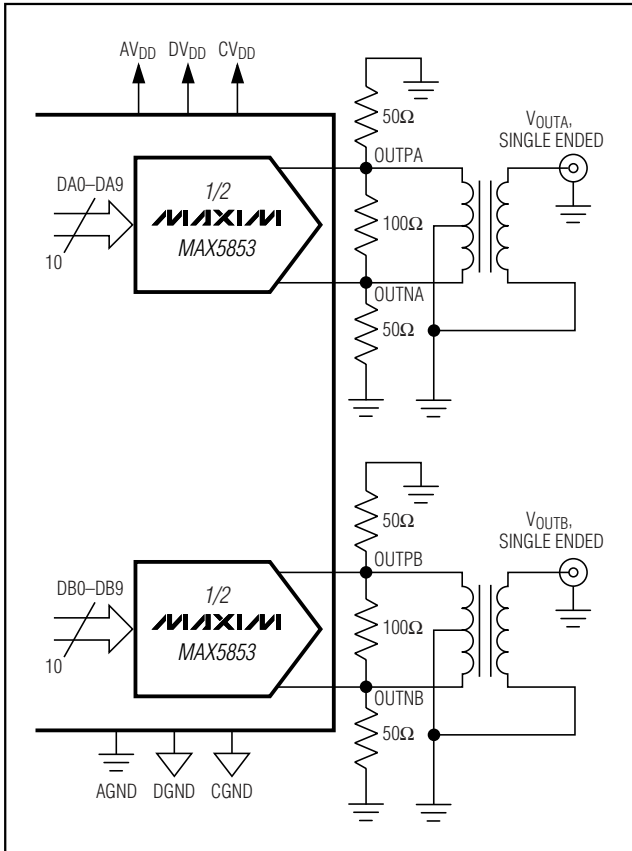

Figure 7. Application with Output Transformer Performing Differential-to-Single-Ended Conversion

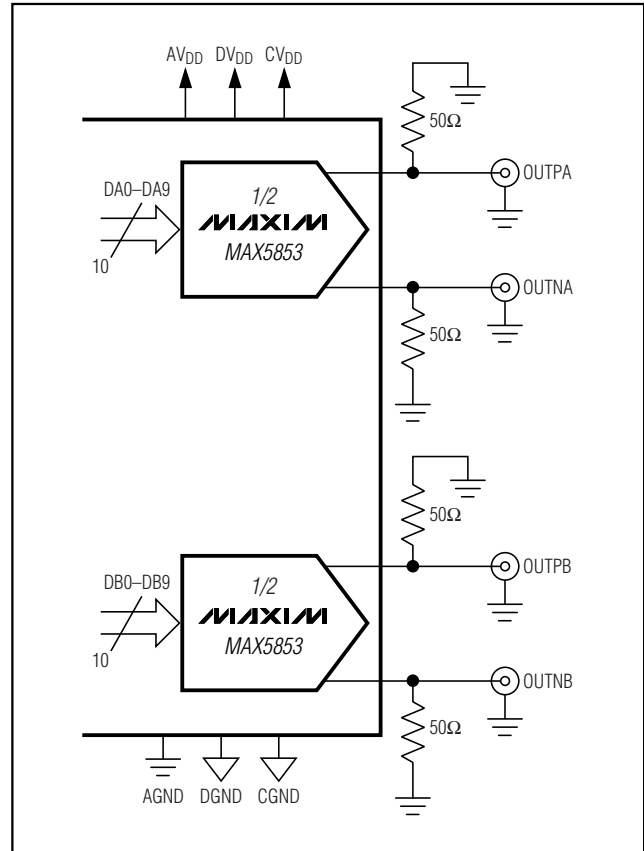

Figure 8. Application with DC-Coupled Differential Outputs

## Applications Information

### Differential-to-Single-Ended Conversion

The MAX5853 exhibits excellent dynamic performance to synthesize a wide variety of modulation schemes, including high-order QAM modulation with OFDM.

Figure 7 shows a typical application circuit with output transformers performing the required differential-to-single-ended signal conversion. In this configuration, the MAX5853 operates in differential mode, which reduces even-order harmonics, and increases the available output power.

### Differential DC-Coupled Configuration

Figure 8 shows the MAX5853 output operating in differential, DC-coupled mode. This configuration can be used in communication systems employing analog quadrature upconverters and requiring a baseband sampling, dual-channel, high-speed DAC for I/Q syn-

thesis. In these applications, information bandwidth can extend from 10MHz down to several hundred kilohertz. DC-coupling is desirable to eliminate long discharge time constants that are problematic with large, expensive coupling capacitors. Analog quadrature upconverters have a DC common-mode input requirement of typically 0.7V to 1.0V. The MAX5853 differential I/Q outputs can maintain the desired full-scale level at the required 0.7V to 1.0V DC common-mode level when powered from a single 2.85V ( $\pm 5\%$ ) supply. The MAX5853 meets this low-power requirement with minimal reduction in dynamic range while eliminating the need for level-shifting resistor networks.

### Power Supplies, Bypassing, Decoupling, and Layout

Grounding and power-supply decoupling strongly influence the MAX5853 performance. Unwanted digital crosstalk can couple through the input, reference,

## Dual, 10-Bit, 80Mps, Current-Output DAC

power-supply, and ground connections, which can affect dynamic specifications, like signal-to-noise ratio or spurious-free dynamic range. In addition, electromagnetic interference (EMI) can either couple into or be generated by the MAX5853. Observe the grounding and power-supply decoupling guidelines for high-speed, high-frequency applications. Follow the power supply and filter configuration to realize optimum dynamic performance.

Use of a multilayer printed circuit (PC) board with separate ground and power-supply planes is recommended. Run high-speed signals on lines directly above the ground plane. The MAX5853 has separate analog and digital ground buses (AGND, CGND, and DGND, respectively). Provide separate analog, digital, and clock ground sections on the PC board with only one point connecting the three planes. The ground connection points should be located underneath the device and connected to the exposed paddle. Run digital signals above the digital ground plane and analog/clock signals above the analog/clock ground plane. Digital signals should be kept away from sensitive analog, clock, and reference inputs. Keep digital signal paths short and metal trace lengths matched to avoid propagation delay and data skew mismatch.

The MAX5853 includes three separate power-supply inputs: analog (AV<sub>DD</sub>), digital (DV<sub>DD</sub>), and clock (CV<sub>DD</sub>). Use a single linear regulator power source to branch out to three separate power-supply lines (AV<sub>DD</sub>, DV<sub>DD</sub>, CV<sub>DD</sub>) and returns (AGND, DGND, CGND). Filter each power-supply line to the respective return line using LC filters comprising ferrite beads and 10µF capacitors. Filter each supply input locally with 0.1µF ceramic capacitors to the respective return lines.

**Note:** To maintain the dynamic performance of the *Electrical Characteristics*, ensure the voltage difference between DV<sub>DD</sub>, AV<sub>DD</sub>, and CV<sub>DD</sub> does not exceed 150mV.

### Thermal Characteristics and Packaging

#### Thermal Resistance

40-lead thin QFN-EP:

$$\theta_{JA} = 38^{\circ}\text{C/W}$$

The MAX5853 is packaged in a 40-pin thin QFN-EP package, providing greater design flexibility, increased thermal efficiency, and optimized AC performance of the DAC. The EP enables the implementation of grounding techniques, which are necessary to ensure highest performance operation.

In this package, the data converter die is attached to an EP leadframe with the back of this frame exposed at the package bottom surface, facing the PC board side of the package. This allows a solid attachment of the package to the PC board with standard infrared (IR) flow soldering techniques. A specially created land pattern on the PC board, matching the size of the EP (4.1mm × 4.1mm), ensures the proper attachment and grounding of the DAC. Designing vias\* into the land area and implementing large ground planes in the PC board design allows for highest performance operation of the DAC. Use an array of 3 × 3 vias (≤0.3mm diameter per via hole and 1.2mm pitch between via holes) for this 40-pin thin QFN-EP package (package code: T4066-1).

### Dynamic Performance Parameter Definitions

#### Total Harmonic Distortion (THD)

THD is the ratio of the RMS sum of all essential harmonics (within a Nyquist window) of the input signal to the fundamental itself. This can be expressed as:

$$\text{THD} = 20 \times \log \left( \frac{\sqrt{V_2^2 + V_3^2 + V_4^2 \dots + V_N^2}}{V_1} \right)$$

where  $V_1$  is the fundamental amplitude, and  $V_2$  through  $V_N$  are the amplitudes of the 2nd through Nth order harmonics. The MAX5853 uses the first seven harmonics for this calculation.

#### Spurious-Free Dynamic Range (SFDR)

SFDR is the ratio of RMS amplitude of the carrier frequency (maximum signal component) to the RMS value of their next-largest spectral component. SFDR is usually measured in dBc with respect to the carrier frequency amplitude or in dBFS with respect to the DAC's full-scale range. Depending on its test condition, SFDR is observed within a predefined window or to Nyquist.

#### Multitone Power Ratio (MTPR)

A series of equally spaced tones are applied to the DAC with one tone removed from the center of the range. MTPR is defined as the worst-case distortion (usually a 3rd-order harmonic product of the fundamental frequencies), which appears as the largest spur at the frequency of the missing tone in the sequence. This test can be performed with any number of input tones; however, four and eight tones are among the most common test conditions for CDMA- and GSM/EDGE-type applications.

\*Vias connect the land pattern to internal or external copper planes.



# Dual, 10-Bit, 80MSPS, Current-Output DAC

MAX5853

## Intermodulation Distortion (IMD)

The two-tone IMD is the ratio expressed in dBc of either output tone to the worst 3rd-order (or higher) IMD products.

## Static Performance Parameter Definitions

### Integral Nonlinearity (INL)

Integral nonlinearity (INL) is the deviation of the values on an actual transfer function from a line drawn between the end points of the transfer function, once offset and gain errors have been nullified. For a DAC, the deviations are measured at every individual step.

### Differential Nonlinearity (DNL)

Differential nonlinearity (DNL) is the difference between an actual step height and the ideal value of 1 LSB. A DNL error specification no more negative than -1 LSB guarantees monotonic transfer function.

### Offset Error

Offset error is the current flowing from positive DAC output when the digital input code is set to zero. Offset error is expressed in LSBs.

### Gain Error

A gain error is the difference between the ideal and the actual full-scale output current on the transfer curve, after nullifying the offset error. This error alters the slope of the transfer function and corresponds to the same percentage error in each step. The ideal current is defined by reference voltage at  $V_{REF0} / I_{REF} \times 32$ .

## Settling Time

The settling time is the amount of time required from the start of a transition until the DAC output settles to its new output value to within the converter's specified accuracy.

## Glitch Impulse

A glitch is generated when a DAC switches between two codes. The largest glitch is usually generated around the midscale transition, when the input pattern transitions from 011...111 to 100...000. This occurs due to timing variations between the bits. The glitch impulse is found by integrating the voltage of the glitch at the midscale transition over time. The glitch impulse is usually specified in pV-s.

Table 4. Part Selection Table

PART	SPEED (MSPS)	RESOLUTION
MAX5851	80	8-bit, dual
MAX5852	165	8-bit, dual
MAX5853	80	10-bit, dual
MAX5854	165	10-bit, dual

## Chip Information

TRANSISTOR COUNT: 9,035

PROCESS: CMOS

# Dual, 10-Bit, 80MSPS, Current-Output DAC

## Package Information

(The package drawing(s) in this data sheet may not reflect the most current specifications. For the latest package outline information, go to [www.maxim-ic.com/packages](http://www.maxim-ic.com/packages).)

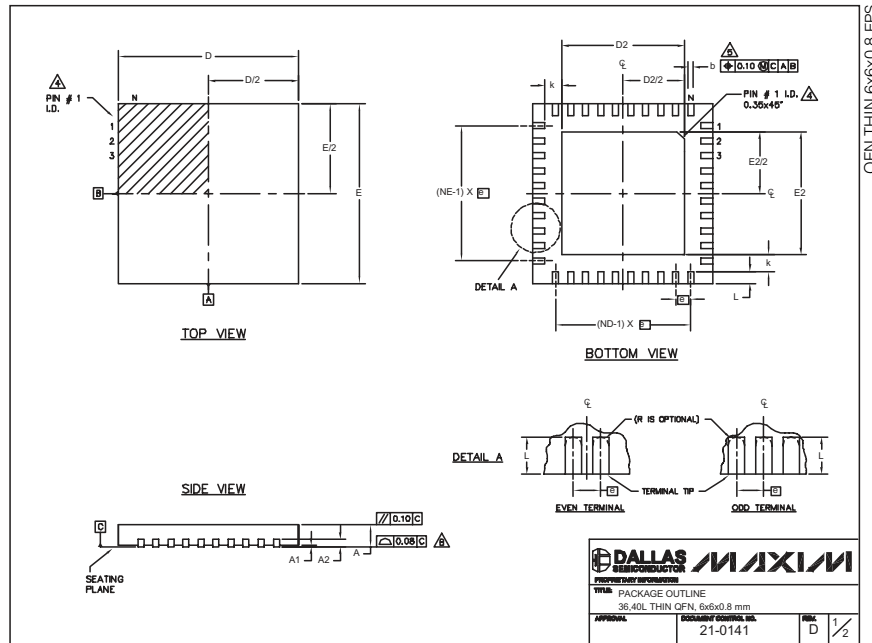

COMMON DIMENSIONS						EXPOSED PAD VARIATIONS					
PKG. SYMBOL	36L 6x6			40L 6x6			D2		E2		
	MIN.	NOM.	MAX.	MIN.	NOM.	MAX.	MIN.	NOM.	MAX.	MIN.	MAX.
A	0.70	0.75	0.80	0.70	0.75	0.80					
A1	0	0.02	0.05	0	0.02	0.05					
A2	0.20 REF.			0.20 REF.							
b	0.20	0.25	0.30	0.20	0.25	0.30					
D	5.90	6.00	6.10	5.90	6.00	6.10					
E	5.90	6.00	6.10	5.90	6.00	6.10					
e	0.50 BSC.			0.50 BSC.							
k	0.25	-	-	0.25	-	-					
L	0.46	0.66	0.66	0.30	0.40	0.50					
N	36			40							
ND	9			10							
NE	9			10							
JEDEC	WJJD-1			WJJD-2							

NOTES:

- DIMENSIONING & TOLERANCING CONFORM TO ASME Y14.5M-1994.
- ALL DIMENSIONS ARE IN MILLIMETERS. ANGLES ARE IN DEGREES.
- N IS THE TOTAL NUMBER OF TERMINALS.

△ THE TERMINAL #1 IDENTIFIER AND TERMINAL NUMBERING CONVENTION SHALL CONFORM TO JEDEC SPP-012. DETAILS OF TERMINAL #1 IDENTIFIER ARE OPTIONAL, BUT MUST BE LOCATED WITHIN THE ZONE INDICATED. THE TERMINAL #1 IDENTIFIER MAY BE EITHER A MOLD OR MARKED FEATURE.

△ DIMENSION b APPLIES TO METALLIZED TERMINAL AND IS MEASURED BETWEEN 0.25 mm AND 0.30 mm FROM TERMINAL TIP.

- ND AND NE REFER TO THE NUMBER OF TERMINALS ON EACH D AND E SIDE RESPECTIVELY.
- DEPOPULATION IS POSSIBLE IN A SYMMETRICAL FASHION.
- COPLANARITY APPLIES TO THE EXPOSED HEAT SINK SLUG AS WELL AS THE TERMINALS.
- DRAWING CONFORMS TO JEDEC MO220.
- WARPAGE SHALL NOT EXCEED 0.10 mm.

**DALLAS SEMICONDUCTOR**  
MAXIM  
PACKAGE OUTLINE  
36, 40L THIN QFN, 6x6x0.8 mm  
APPROVAL: [ ] DOCUMENT CONTROL: [ ] REL. D 2/2  
21-0141

Maxim cannot assume responsibility for use of any circuitry other than circuitry entirely embodied in a Maxim product. No circuit patent licenses are implied. Maxim reserves the right to change the circuitry and specifications without notice at any time.

18 **Maxim Integrated Products, 120 San Gabriel Drive, Sunnyvale, CA 94086 408-737-7600**