

The Altech Selection of Breakers	4-5
Application Examples UL508A	6-9
UL489 Miniature Molded Case Circuit Breakers	
UL (AC), DL (DC) Series	
• UL489 Miniature Molded Case Circuit Breaker.....	10-11
• C Trip Characteristic AC	12
• D Trip Characteristic AC	13
• C Trip Characteristic DC	14
• D Trip Characteristic DC.....	15
• Accessories for UL/DL Series	16
• Trip Curves and Technical Data	17-19
L (AC or DC) Series	
• UL489 Miniature Molded Case Circuit Breaker.....	20-21
• C Trip Characteristic AC	22
• D Trip Characteristic AC	23
• C and D Trip Characteristics DC	24
• Trip Curves and Technical Data.....	25
• Accessories for L Series	26-27
UL489 Busbar System	
• Introduction and Ordering Information	28-35
UL508 Manual Motor Controllers “Suitable as Motor Disconnect”	
UM (V-EA) Series	
• UL508 Manual Motor Controllers “Suitable as Motor Disconnect”.....	36-37
• B Trip Characteristic	38
• C Trip Characteristic	39
• D Trip Characteristic	40
• E Trip Characteristic	41
• G Trip Characteristic.....	42
• Z Trip Characteristic.....	43
• Trip Curves and Technical Data	44-47
MA Series	
• Three Phase Adjustable Trip Miniature Circuit Breakers/Manual Motor Controllers	48-49
• Accessories V-EA/MA Series	50-51
MS Series	
• Three Phase Adjustable Trip Economy Manual Motor Controllers.....	52
• Accessories MS Series	53
UL1077 Supplementary Protectors	
UR Series	
• UL1077 Supplementary Protectors.....	54-55
• B Trip Characteristic	56
• C Trip Characteristic	57
• D Trip Characteristic	58
• Accessories UR Series	59
• Trip Curves and Technical Data	60-61
R Series	
• UL1077 Supplementary Protectors.....	62-63
• B Trip Characteristic	64
• C Trip Characteristic	65
• D Trip Characteristic	66
• Trip Curves and Technical Data.....	67
• Accessories UR Series	68-69
UL1077 / UL508 Busbar System	
• Introduction and Ordering Information	70-79
TR Series UL1077 Recognized Supplementary Protector /Circuit Breaker for Equipment	80-85
RP Series RCCB Earth Leakage Circuit Breaker	86-87
Index	88-93
Terms and Conditions	94

UL 489

UL 508

UL 1077

UL 1077
Equipment Breakers

Earth Leakage
Circuit Breakers

ANNEX

The Altech Selection of Breakers

The Advantages

In today's very competitive marketplace you need reliability, so you need to use circuit breakers that are high quality and technically correct for your application. Altech is a US leader in DIN rail mounted breakers with ratings up to 63A. Only Altech offers DIN rail mounted breakers that meet UL489, UL508 or UL1077 approvals with a short circuit interrupt capacity of up to 10kA. No other manufacturer offers this complete line. This assures you the right product for your application requirements.

UL (AC), DL (DC), V-EA and UR Series Advantages



UL 489

UL (AC), DL (DC) Series UL489 Miniature Molded Case Circuit Breakers



IEC 60947-2
Short Circuit Tested

ACCESSORIES

- Auxiliary Contact, Alarm Switch
- Shunt Trip
- Neutral Pole
- Undervoltage Trip (not UL)
- Touch Protection Caps
- Cooling Spacer
- Mounting Screw 34mm
- Lock-out Adapter

UL 489

UL 508

UL 1077

UL 1077
Equipment B breakers

Earth Leakage
Circuit Breakers

ANNEX

UL 508

UM (V-EA) Series UL508 Manual Motor Controllers
 “Suitable as Motor Disconnect”



ACCESSORIES

- Auxiliary Contact, Alarm Switch
- Shunt Trip
- Undervoltage Trip (not UL)
- Neutral Pole
- Touch Protection Caps
- Cooling Spacer
- Mounting Screw 34mm
- Lock-out Adapter**



UL508 Listed
E511762



300600



up to 25A
B,C,D curve



up to 25A
B,C,D curve



UL 1077

**UR Series UL1077 Recognized
Supplementary Protector**



ACCESSORIES

- Auxiliary Contact, Alarm Switch
- Shunt Trip
- Undervoltage Trip (not UL)
- Neutral Pole
- Touch Protection Caps
- Cooling Spacer
- Mounting Screw 34mm
- Lock-out Adapter

**2 series, 5 lines, 3 UL approvals, AC and DC models
and the most trip curves in the industry.**

Altech has the broadest offering in the industry.

Typical UL508A Panel

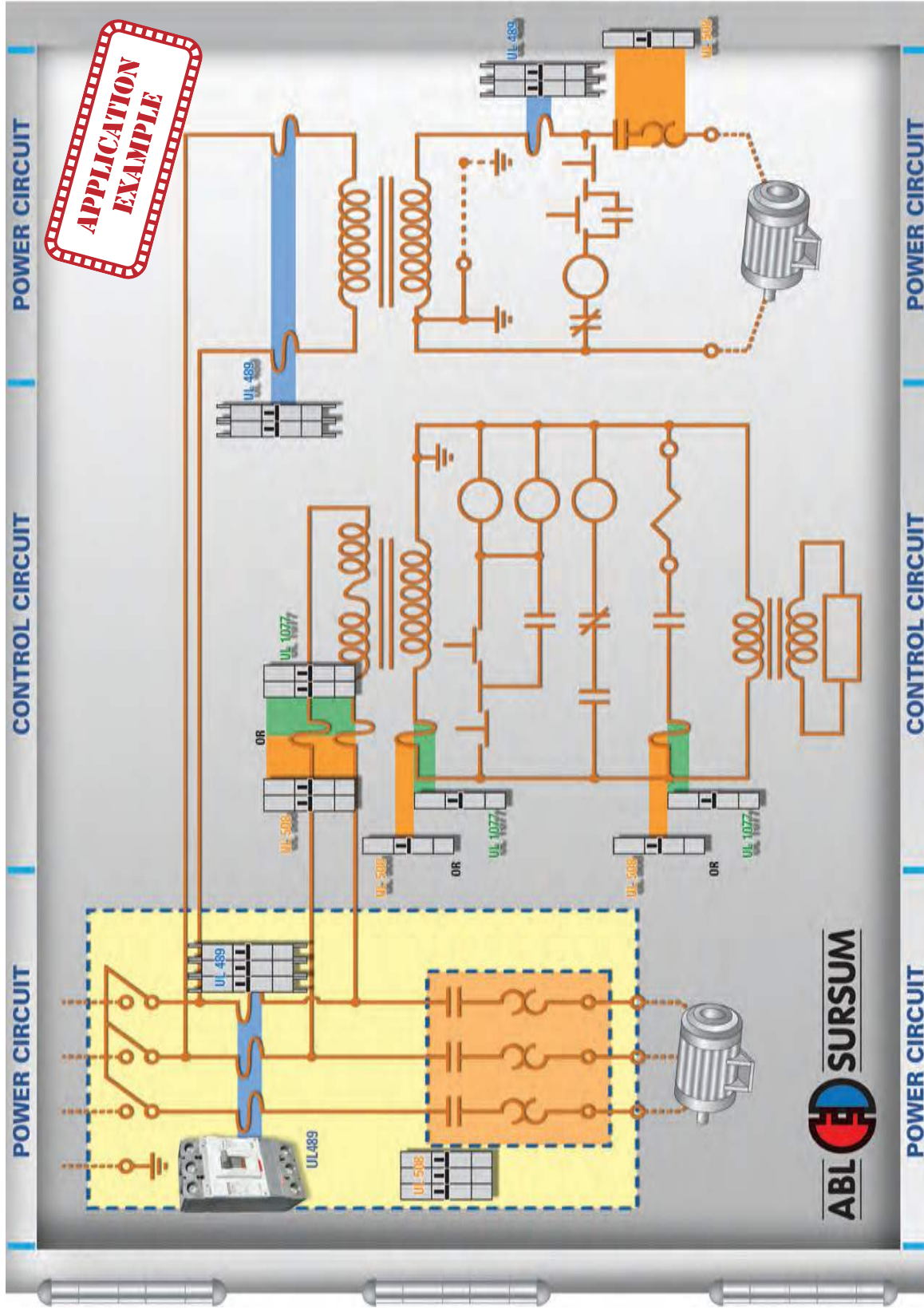

Disclaimer: This is an application example. Installation should be done by a qualified electrician under the guidance of UL/NEC® specifications.

Typical Motor Group Installation

(see NEC® article 430.53 for reference and more information).

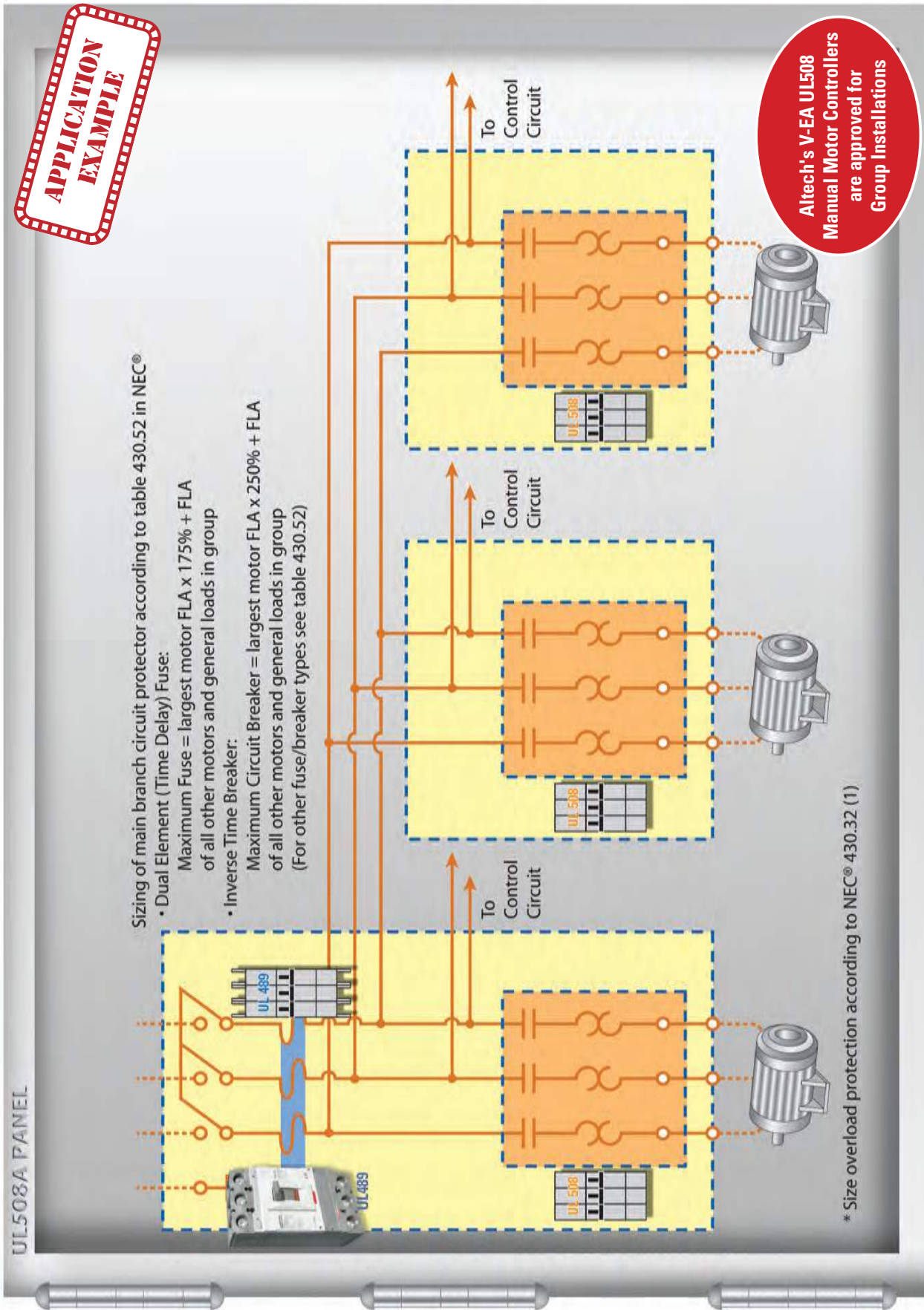

Disclaimer: This is an application example. Installation should be done by a qualified electrician under the guidance of UL/NEC® specifications.

Typical Motor Group Installation

(see NEC® article 430.53 for reference and more information).

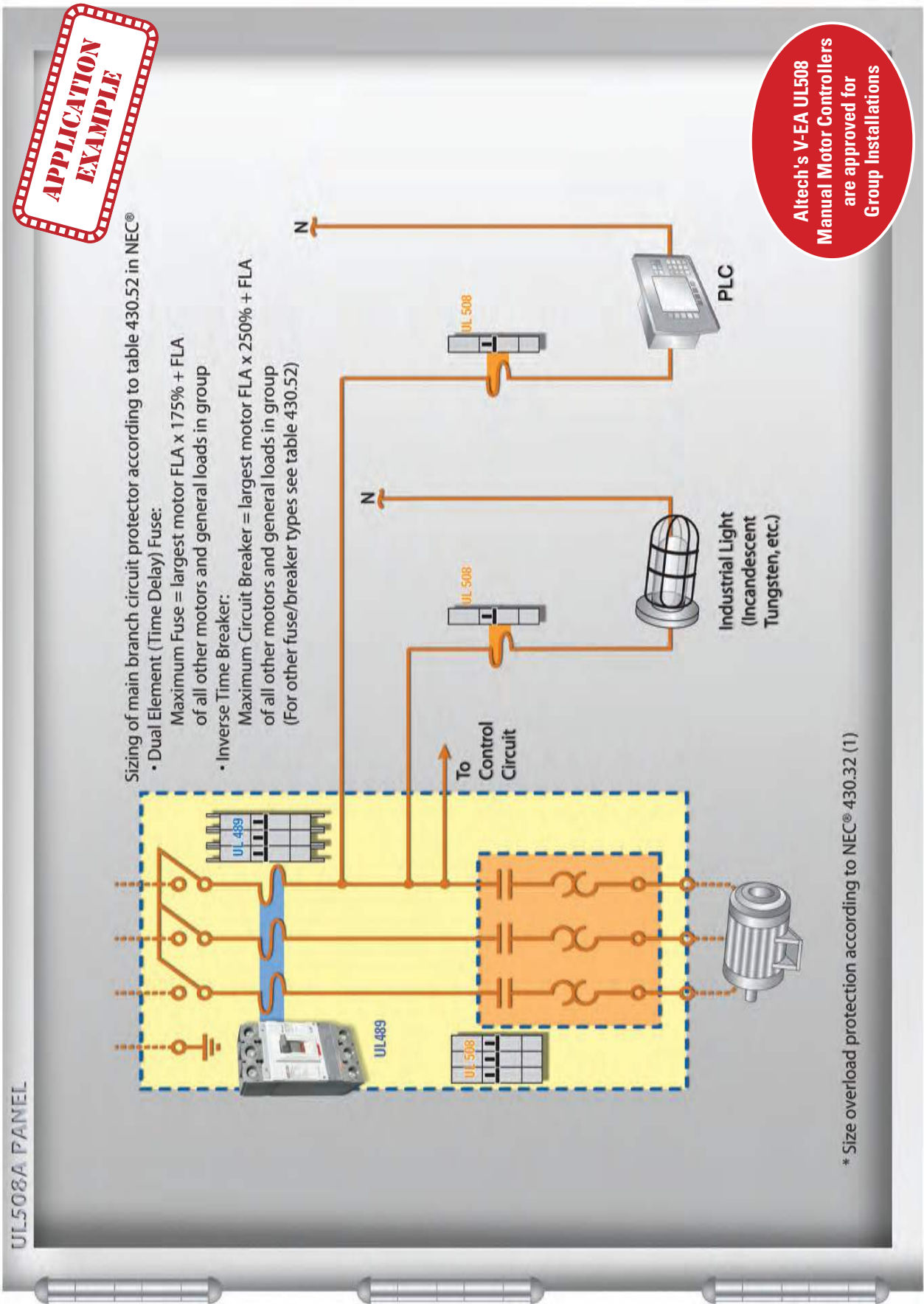

Disclaimer: This is an application example. Installation should be done by a qualified electrician under the guidance of UL/NEC® specifications.

UL 489

UL 508

UL 1077

UL 1077 Equipment Breakers

Earth Leakage Circuit Breakers

ANNEX

UL(AC), DL(DC) Series

UL489 Miniature Molded Case Circuit Breakers

- Available in AC and DC models
- DIN Rail Mounted
- 17.5mm width
- Thermal Magnetic
- 240V, 480Y/277V AC, 50/60Hz
- 125V DC (1 pole); 125/250V DC (2 pole)
- 10kA Short Circuit Interrupting Capacity
- HACR Type 40°C
- Line/Load reversible



Current/ Voltage Rating	
UL-Series	0.3 - 63A/240V AC, 0.3-32A/480Y/277V AC* (48V DC / pole pending)
DL-Series	0.3 - 63A/125/250V DC
Calibration Temperature	40°C (104°F)
Ambient Temperature	-25°C to +70°C (-13°F to 158°F)
Storage Temperature	-40°C to +70°C (-40°F to 158°F)
Terminal Size Acceptability	Top: 18-3 AWG; Bottom: 18-2 AWG
Terminal Torque (min/max)	2 Nm (17.7 lb.in.) / 2.5Nm (22.2 lb.in)
Electrical Life	6,000 switching cycles ON/ OFF
Mechanical Life	10,000 switching cycles ON/ OFF
Vibration Resistance	> 15g according to DIN EN 60069-2-59 during a load with $I_1 = 1.05 \times I_N$
Resistance to mechanical shocks	25g @ 11ms
Degree of protection acc. IEC/EN 60529	IP20
Mounting Orientation	In any plane

*One device, dual voltage ratings.

Short Circuit Interrupting Capacity According to UL 489

No. Poles	Type	0.3-32A	40-63A
1	AC	10kA @ 120, 240, 277V	10kA @ 120, 240V
2-3	AC	10kA @ 120, 240, 480Y/277V	10kA @ 120 240V

No. Poles	Type	0.3-32A	40-63A
1	DC	10kA @ 125V	10kA @ 125V
2	DC	10kA @ 125/250V	10kA @ 125/250V

Short Circuit Interrupting Capacity According to IEC 60947-2, DIN EN 60947-2

No. Poles	Type	0.3-32	40-63A
1	AC	15kA @ 240V	15kA @ 240V
2-3	AC	15kA @ 415V	10kA @ 415V

Marking Details

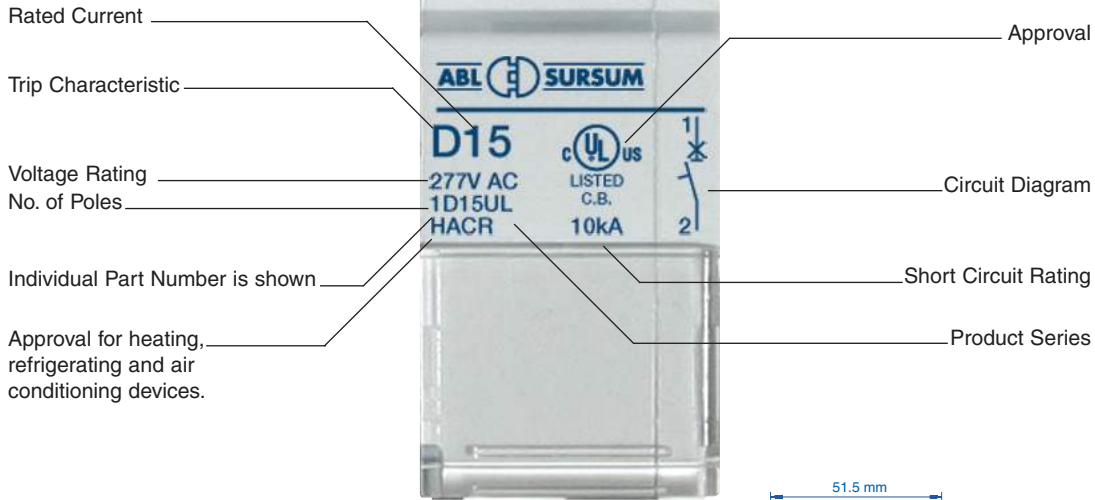

Dimensions in mm

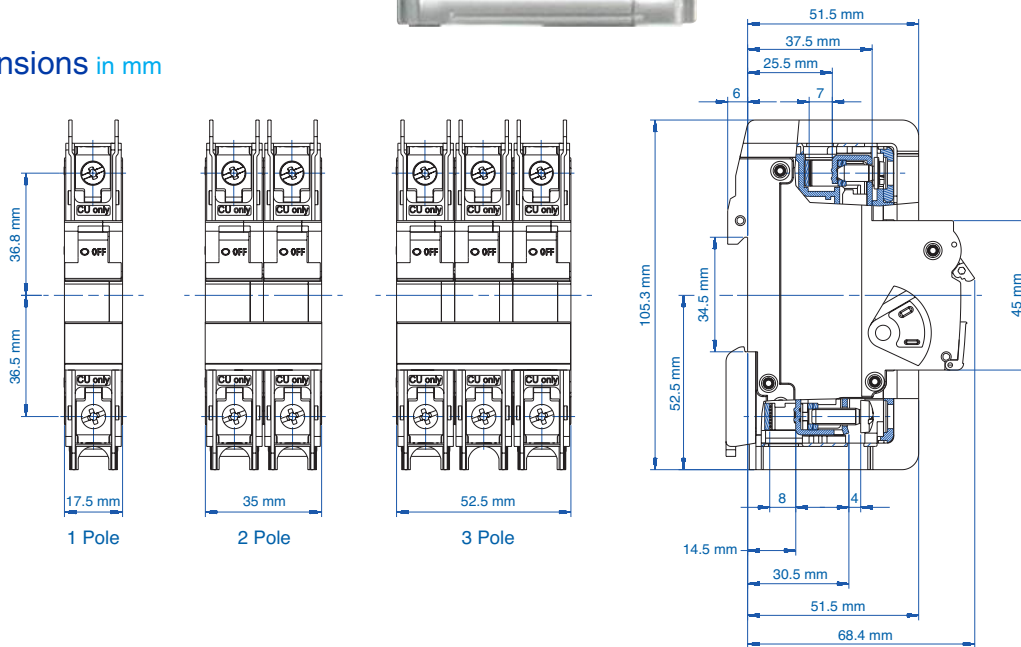

Trip-Characteristics*				Applications								
Characteristic Trip Boundaries				Lighting Wiring Protection Control Circuits	Business Equipment Appliances	Transformers	Power Supplies Heaters	Motors		Reactive Load	Telecommu- nications/ Computer Equipment	Power Supplies
Thermal Trip		Magnetic Trip						Low Inrush	High Inrush			
Must not Trip>100ms	Must Trip <1hr	Must not Trip>100ms	Must Trip at 100ms									
C-Characteristics AC												
1.05xRC	1.35xRC	5xRC	10xRC									
C-Characteristics DC												
1.05xRC	1.35xRC	7xRC	14xRC									
D-Characteristics AC												
1.05xRC	1.35xRC	10xRC	16xRC									
D-Characteristics DC												
1.05xRC	1.35xRC	14xRC	22.4xRC									

*The value of each characteristic is shown vertically beneath its corresponding heading.



Warning!

This information should only be used as a selection guide. The use of a Miniature Circuit Breaker in an application with a certain Trip-Characteristic always requires prototype testing! It is the responsibility of the circuit design engineer to select the appropriate Miniature Circuit Breaker for his specific application.

UL 489

UL 508

UL 1077

UL 1077
Equipment Breakers

Earth Leakage
Circuit Breakers

ANNEX

UL - Series

C-Trip

Characteristic



Application Examples:

Low inrush motors, resistive loads, wiring protection, receptacles, lighting, and control circuit applications. Relatively short thermal trip delay and medium magnetic trip point.



Standard Pack: 12

Weight:

0.3-32A:

1.74kg (3.83lb.)

40-63A:

1.98kg (4.37lb.)

One Pole

Rated Current	Type/ Cat. No.	Rated Voltage
0.3A	1C03UL	277V AC
0.5A	1C05UL	277V AC
1.0A	1C1UL	277V AC
1.6A	1C1.6UL	277V AC
2.0A	1C2UL	277V AC
3.0A	1C3UL	277V AC
4.0A	1C4UL	277V AC
5.0A	1C5UL	277V AC
6.0A	1C6UL	277V AC
8.0A	1C8UL	277V AC
10A	1C10UL	277V AC
12A	1C12UL	277V AC
13A	1C13UL	277V AC
15A	1C15UL	277V AC
16A	1C16UL	277V AC
20A	1C20UL	277V AC
25A	1C25UL	277V AC
30A	1C30UL	277V AC
32A	1C32UL	277V AC
40A	1C40UL	240V AC
50A	1C50UL	240V AC
60A	1C60UL	240V AC
63A	1C63UL	240V AC



Standard Pack: 4

Weight:

0.3-32A:

1.74kg (3.83lb.)

40-63A:

1.98kg (4.37lb.)

Three Pole

Rated Current	Type/ Cat. No.	Rated Voltage
0.3A	3C03UL	480Y/277V AC
0.5A	3C05UL	480Y/277V AC
1.0A	3C1UL	480Y/277V AC
1.6A	3C1.6UL	480Y/277V AC
2.0A	3C2UL	480Y/277V AC
3.0A	3C3UL	480Y/277V AC
4.0A	3C4UL	480Y/277V AC
5.0A	3C5UL	480Y/277V AC
6.0A	3C6UL	480Y/277V AC
8.0A	3C8UL	480Y/277V AC
10A	3C10UL	480Y/277V AC
12A	3C12UL	480Y/277V AC
13A	3C13UL	480Y/277V AC
15A	3C15UL	480Y/277V AC
16A	3C16UL	480Y/277V AC
20A	3C20UL	480Y/277V AC
25A	3C25UL	480Y/277V AC
30A	3C30UL	480Y/277V AC
32A	3C32UL	480Y/277V AC
40A	3C40UL	240V AC
50A	3C50UL	240V AC
60A	3C60UL	240V AC
63A	3C63UL	240V AC



Standard Pack: 6

Weight:

0.3-32A:

1.74kg (3.83lb.)

40-63A:

1.98kg (4.37lb.)

Two Pole

Rated Current	Type/ Cat. No.	Rated Voltage
0.3A	2C03UL	480Y/277V AC
0.5A	2C05UL	480Y/277V AC
1.0A	2C1UL	480Y/277V AC
1.6A	2C1.6UL	480Y/277V AC
2.0A	2C2UL	480Y/277V AC
3.0A	2C3UL	480Y/277V AC
4.0A	2C4UL	480Y/277V AC
5.0A	2C5UL	480Y/277V AC
6.0A	2C6UL	480Y/277V AC
8.0A	2C8UL	480Y/277V AC
10A	2C10UL	480Y/277V AC
12A	2C12UL	480Y/277V AC
13A	2C13UL	480Y/277V AC
15A	2C15UL	480Y/277V AC
16A	2C16UL	480Y/277V AC
20A	2C20UL	480Y/277V AC
25A	2C25UL	480Y/277V AC
30A	2C30UL	480Y/277V AC
32A	2C32UL	480Y/277V AC
40A	2C40UL	240V AC
50A	2C50UL	240V AC
60A	2C60UL	240V AC
63A	2C63UL	240V AC



Add-on Neutral Pole

Rated Current	Type/ Cat. No.	Rated Voltage
0.3-32A	N32UL	480/277V AC
40-63A	N63UL	240V AC

Standard Pack: 6

Weight:

0.99kg (2.18 lb.)

UL - Series

**D-Trip
Characteristic**



E329510

Application Examples:

High inrush motors, transformers, power supplies, heaters and reactive loads. Relatively long thermal trip delay and very high magnetic trip point.



Standard Pack: 12

Weight:
0.3-32A:
1.74kg (3.83lb.)
40-63A:
1.98kg (4.37lb.)

One Pole

Rated Current	Type/ Cat. No.	Rated Voltage
0.3A	1D03UL	277V AC
0.5A	1D05UL	277V AC
1.0A	1D1UL	277V AC
1.6A	1D1.6UL	277V AC
2.0A	1D2UL	277V AC
3.0A	1D3UL	277V AC
4.0A	1D4UL	277V AC
5.0A	1D5UL	277V AC
6.0A	1D6UL	277V AC
8.0A	1D8UL	277V AC
10A	1D10UL	277V AC
12A	1D12UL	277V AC
13A	1D13UL	277V AC
15A	1D15UL	277V AC
16A	1D16UL	277V AC
20A	1D20UL	277V AC
25A	1D25UL	277V AC
30A	1D30UL	277V AC
32A	1D32UL	277V AC
40A	1D40UL	240V AC
50A	1D50UL	240V AC
60A	1D60UL	240V AC
63A	1D63UL	240V AC



Standard Pack: 4

Weight:
0.3-32A:
1.74kg (3.83lb.)
40-63A:
1.98kg (4.37lb.)

Three Pole

Rated Current	Type/ Cat. No.	Rated Voltage
0.3A	3D03UL	480Y/277V AC
0.5A	3D05UL	480Y/277V AC
1.0A	3D1UL	480Y/277V AC
1.6A	3D1.6UL	480Y/277V AC
2.0A	3D2UL	480Y/277V AC
3.0A	3D3UL	480Y/277V AC
4.0A	3D4UL	480Y/277V AC
5.0A	3D5UL	480Y/277V AC
6.0A	3D6UL	480Y/277V AC
8.0A	3D8UL	480Y/277V AC
10A	3D10UL	480Y/277V AC
12A	3D12UL	480Y/277V AC
13A	3D13UL	480Y/277V AC
15A	3D15UL	480Y/277V AC
16A	3D16UL	480Y/277V AC
20A	3D20UL	480Y/277V AC
25A	3D25UL	480Y/277V AC
30A	3D30UL	480Y/277V AC
32A	3D32UL	480Y/277V AC
40A	3D40UL	240V AC
50A	3D50UL	240V AC
60A	3D60UL	240V AC
63A	3D63UL	240V AC



Standard Pack: 6

Weight:
0.3-32A:
1.74kg (3.83lb.)
40-63A:
1.98kg (4.37lb.)

Two Pole

Rated Current	Type/ Cat. No.	Rated Voltage
0.3A	2D03UL	480Y/277V AC
0.5A	2D05UL	480Y/277V AC
1.0A	2D1UL	480Y/277V AC
1.6A	2D1.6UL	480Y/277V AC
2.0A	2D2UL	480Y/277V AC
3.0A	2D3UL	480Y/277V AC
4.0A	2D4UL	480Y/277V AC
5.0A	2D5UL	480Y/277V AC
6.0A	2D6UL	480Y/277V AC
8.0A	2D8UL	480Y/277V AC
10A	2D10UL	480Y/277V AC
12A	2D12UL	480Y/277V AC
13A	2D13UL	480Y/277V AC
15A	2D15UL	480Y/277V AC
16A	2D16UL	480Y/277V AC
20A	2D20UL	480Y/277V AC
25A	2D25UL	480Y/277V AC
30A	2D30UL	480Y/277V AC
32A	2D32UL	480Y/277V AC
40A	2D40UL	240V AC
50A	2D50UL	240V AC
60A	2D60UL	240V AC
63A	2D63UL	240V AC



Add-on Neutral Pole

Rated Current	Type/ Cat. No.	Rated Voltage
0.3-32A	N32UL	480/277V AC
40-63A	N63UL	240V AC

Standard Pack: 6

Weight:
0.99kg (2.18 lb.)

UL 489

UL 508

UL 1077

UL 1077
Equipment Breakers

Earth Leakage
Circuit Breakers

ANNEX

DL - Series C-Trip (DC) Characteristic

Application Examples:

Telecommunication equipment,
computer equipment, uninterruptable power supplies.



One Pole



Standard Pack: 12

Weight:

0.3-32A:

1.86kg (4.1lb.)

40-63A:

2.10kg (4.6lb.)

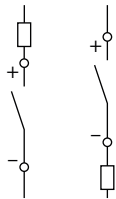

Rated Current	Type/ Cat. No.	Rated Voltage
0.3A	1C03DL	125V DC
0.5A	1C05DL	125V DC
1.0A	1C1DL	125V DC
1.6A	1C1.6DL	125V DC
2.0A	1C2DL	125V DC
3.0A	1C3DL	125V DC
4.0A	1C4DL	125V DC
5.0A	1C5DL	125V DC
6.0A	1C6DL	125V DC
8.0A	1C8DL	125V DC
10A	1C10DL	125V DC
12A	1C12DL	125V DC
13A	1C13DL	125V DC
15A	1C15DL	125V DC
16A	1C16DL	125V DC
20A	1C20DL	125V DC
25A	1C25DL	125V DC
30A	1C30DL	125V DC
32A	1C32DL	125V DC
40A	1C40DL	125V DC
50A	1C50DL	125V DC
60A	1C60DL	125V DC
63A	1C63DL	125V DC

Two Pole



Standard Pack: 6

Weight:

0.3-32A:

1.86kg (4.1lb.)

40-63A:

2.10kg (4.6lb.)

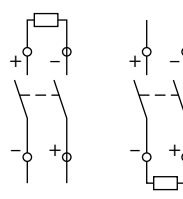

Rated Current	Type/ Cat. No.	Rated Voltage
0.3A	2C03DL	125/250V DC
0.5A	2C05DL	125/250V DC
1.0A	2C1DL	125/250V DC
1.6A	2C1.6DL	125/250V DC
2.0A	2C2DL	125/250V DC
3.0A	2C3DL	125/250V DC
4.0A	2C4DL	125/250V DC
5.0A	2C5DL	125/250V DC
6.0A	2C6DL	125/250V DC
8.0A	2C8DL	125/250V DC
10A	2C10DL	125/250V DC
12A	2C12DL	125/250V DC
13A	2C13DL	125/250V DC
15A	2C15DL	125/250V DC
16A	2C16DL	125/250V DC
20A	2C20DL	125/250V DC
25A	2C25DL	125/250V DC
30A	2C30DL	125/250V DC
32A	2C32DL	125/250V DC
40A	2C40DL	125/250V DC
50A	2C50DL	125/250V DC
60A	2C60DL	125/250V DC
63A	2C63DL	125/250V DC



Warning!

Correct polarity must be observed
when connecting the DC circuit breakers.



DL - Series D-Trip (DC) Characteristic

Application Examples:

Telecommunication equipment,
computer equipment, uninterruptable power supplies.



One Pole



Standard Pack: 12

Weight:
0.3-32A: 1.86kg (4.1lb.)
40-63A: 2.10kg (4.6lb.)

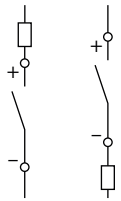

Rated Current	Type/ Cat. No.	Rated Voltage
0.3A	1D03DL	125V DC
0.5A	1D05DL	125V DC
1.0A	1D1DL	125V DC
1.6A	1D1.6DL	125V DC
2.0A	1D2DL	125V DC
3.0A	1D3DL	125V DC
4.0A	1D4DL	125V DC
5.0A	1D5DL	125V DC
6.0A	1D6DL	125V DC
8.0A	1D8DL	125V DC
10A	1D10DL	125V DC
12A	1D12DL	125V DC
13A	1D13DL	125V DC
15A	1D15DL	125V DC
16A	1D16DL	125V DC
20A	1D20DL	125V DC
25A	1D25DL	125V DC
30A	1D30DL	125V DC
32A	1D32DL	125V DC
40A	1D40DL	125V DC
50A	1D50DL	125V DC
60A	1D60DL	125V DC
63A	1D63DL	125V DC



Standard Pack: 6

Weight:
0.3-32A: 1.86kg (4.1lb.)
40-63A: 2.10kg (4.6lb.)

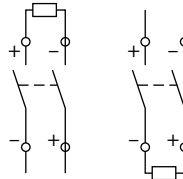

Two Pole

Rated Current	Type/ Cat. No.	Rated Voltage
0.3A	2D03DL	125/250V DC
0.5A	2D05DL	125/250V DC
1.0A	2D1DL	125/250V DC
1.6A	2D1.6DL	125/250V DC
2.0A	2D2DL	125/250V DC
3.0A	2D3DL	125/250V DC
4.0A	2D4DL	125/250V DC
5.0A	2D5DL	125/250V DC
6.0A	2D6DL	125/250V DC
8.0A	2D8DL	125/250V DC
10A	2D10DL	125/250V DC
12A	2D12DL	125/250V DC
13A	2D13DL	125/250V DC
15A	2D15DL	125/250V DC
16A	2D16DL	125/250V DC
20A	2D20DL	125/250V DC
25A	2D25DL	125/250V DC
30A	2D30DL	125/250V DC
32A	2D32DL	125/250V DC
40A	2D40DL	125/250V DC
50A	2D50DL	125/250V DC
60A	2D60DL	125/250V DC
63A	2D63DL	125/250V DC



Warning!
Correct polarity must be observed
when connecting the DC circuit breakers.



UL 489

UL 508

UL 1077

UL 1077
Equipment Breakers

Earth Leakage
Circuit Breakers

ANNEX



Auxiliary Contact, Alarm Switch

Type/ Cat No.	Description	Contacts Type	Std Pk
H10UL	1 Auxiliary Contact	1NO	6
H11UL	2 Auxiliary Contacts	1NO + 1NC	6
H12UL	3 Auxiliary Contacts	1NO + 2NC	6
H21UL	3 Auxiliary Contacts	2NO + 1NC	6
HLS11L*	1 Auxiliary/1 Signal Contact	1CO + 1CO (Signal)	6

Rated Operating Currents	10A@240V AC 3A@110V DC 1A@220V DC
---------------------------------	---

Minimum Contact Load	1mA @ 24V DC
Torque	max. 0.8Nm (7 lb.in)

Wire Range:

Single Wire	1.0mm ² - 2.5mm ² (18-14 AWG)
Stranded Wire	1.0mm ² - 1.5mm ² (18-16 AWG)
Stranded Wire with Ferrule	1.0mm ² - 1.5mm ² (18-16 AWG)

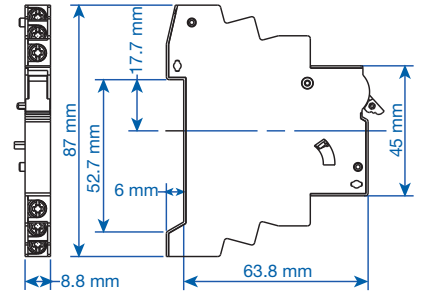

Dimensions HxxUL.

Shunt Trip

Type/ Cat No.	Rated Voltage U _N	Max. Operating Current @ U _N	Std Pk
FA12UL	12V AC/DC	1.3A	5
FA24UL	24V AC/DC	0.6A	5
FA48UL	48 - 72V AC/DC	0.2A	5
FA110UL	110 - 240V AC/DC, 277V AC	0.25A @ 110V 0.5A @ 240V 0.58A @ 277V	5

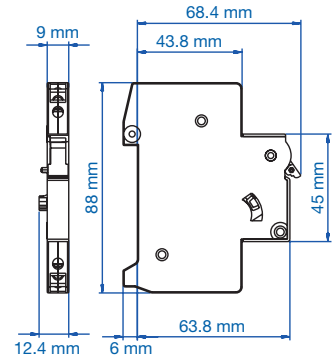

Dimensions HLS11L.



Neutral Pole

Type/ Cat No.	Rated Current I _N	Rated Voltage U _N	Std Pk
N32UL	0.3 - 32A	480Y/277V AC	6
N63UL	40 - 63A	240V AC	6

Touch Protection Caps

to cover the terminal screw holes on the switching devices, neutral Poles and shunt trips for increased touch protection.



Type/ Cat No.	Std Pk
BS.UL	100

Cooling Spacer



Type/ Cat No.	Std Pk
15.960	1

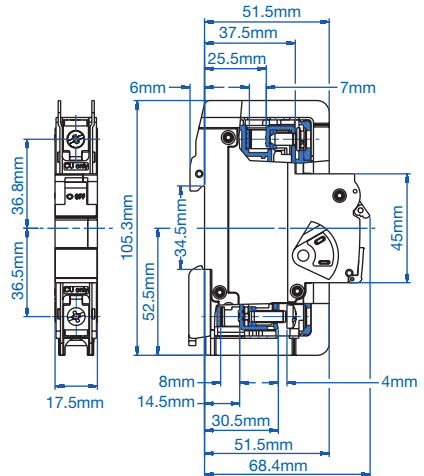

Dimensions NxxUL, FauxUL

Mounting Screw 34mm

to connect the auxiliary contact and shunt trip or neutral Pole to the circuit breaker.



Type/ Cat No.	Std Pk
E983419	10

Lock-out Adapter**



Type/ Cat No.	Std Pk
EASS	10

** UL and DL series can also be locked in the on and off position by simply using a common lead or meter seal, which gets fed through the hole in the handle and a corresponding hole in the housing.

UL Series (AC) Trip Curves

C (AC) Trip Curve

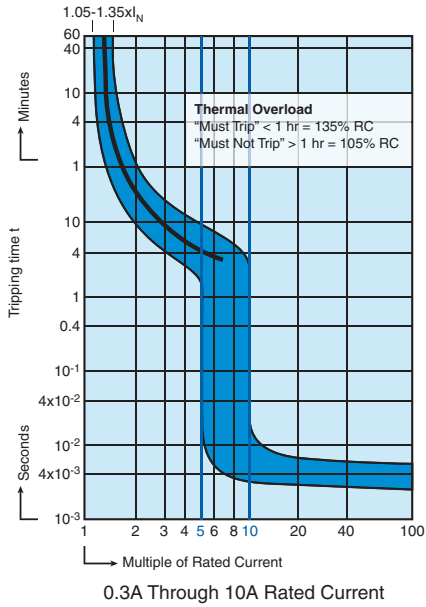

D (AC) Trip Curve

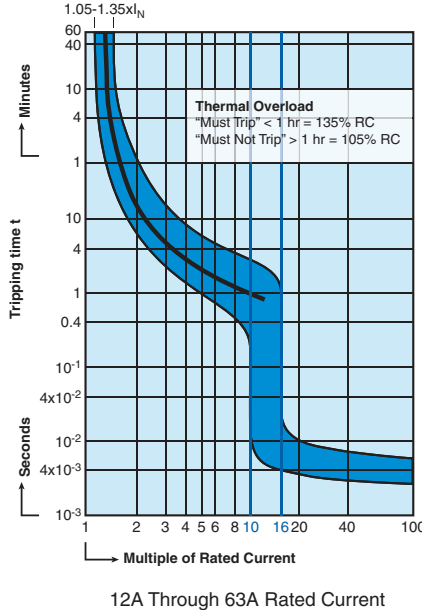
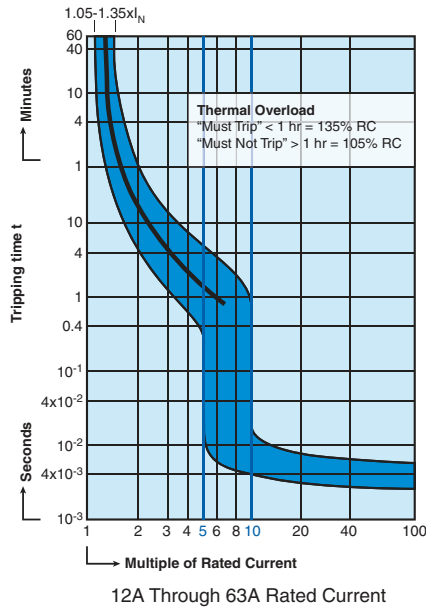
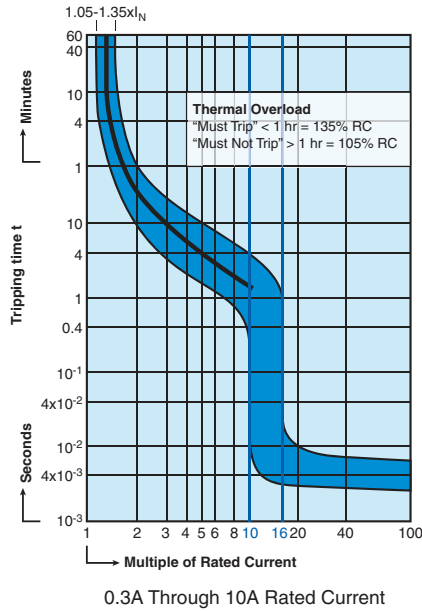

"C" Magnetic Trip Parameters

Rated current 0.3A to 63A.

1. Hold for a minimum of 100ms at surge of 5 times rated current.
2. Trip in under 100ms at 10 times rated current.

"D" Magnetic Trip Parameters

Rated current 0.3A to 63A.

1. Hold for a minimum of 100ms at surge of 10 times rated current.
2. Trip in under 100ms at 16 times rated current.

UL Series (DC) Trip Curves

C (DC) Trip Curve

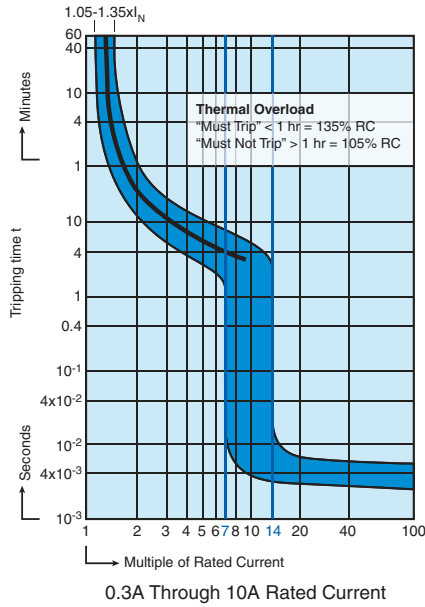

D (DC) Trip Curve

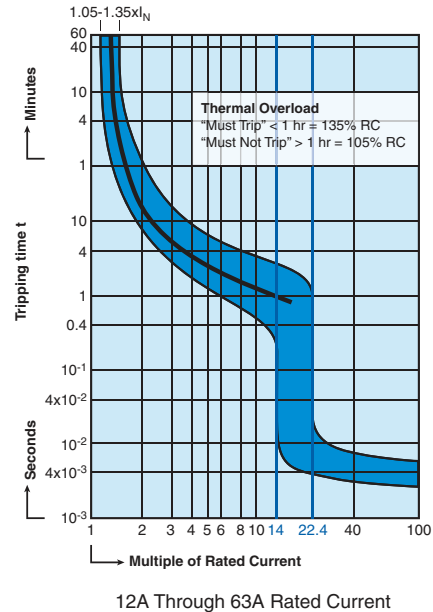
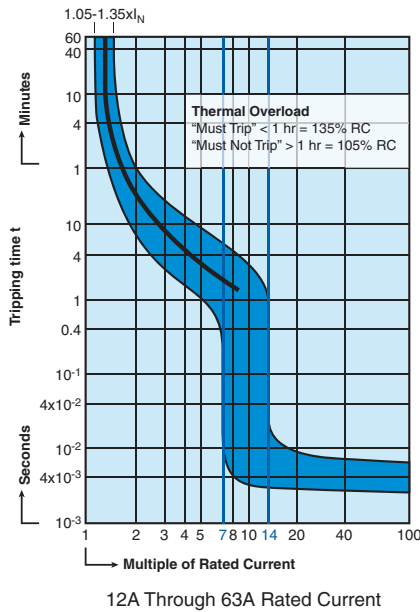
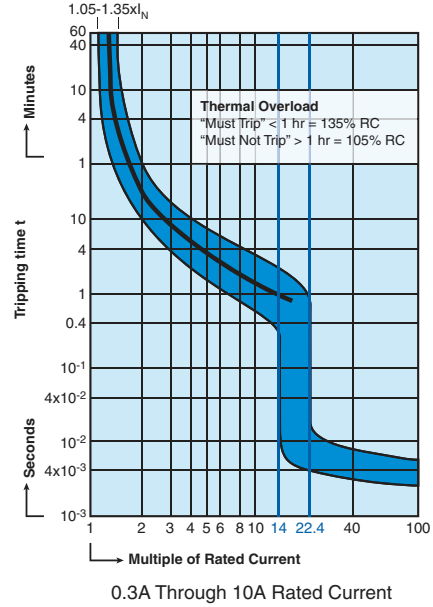

"C" Magnetic Trip Parameters

Rated current 0.3A to 63A.

1. Hold for a minimum of 100ms at surge of 7 times rated current.
2. Trip in under 100ms at 14 times rated current.

"D" Magnetic Trip Parameters

Rated current 0.3A to 63A.

1. Hold for a minimum of 100ms at surge of 14 times rated current.
2. Trip in under 100ms at 22.4 times rated current.

UL/ DL Series Internal Resistance

Rated Current (A)	Trip Characteristic	
	C (Ohm)	D (Ohm)
0.3	16.8620	16.8620
0.5	6.8540	6.0009
1.0	1.7000	1.7560
1.6	0.5870	0.5870
2.0	0.4190	0.4190
3.0	0.2020	0.2020
4.0	0.1090	0.1090
5.0	0.0654	0.0654
6.0	0.0528	0.0491
8.0	0.0278	0.0240
10	0.0216	0.0187
12	0.0084	0.0085
13	0.0084	0.0085
15/ 16	0.0085	0.0076
20	0.0067	0.0064
25	0.0050	0.0041
30/ 32	0.0032	0.0027
40	0.0025	0.0022
50	0.0019	0.0018
60/ 63	0.0018	0.0017

UL Series Let-through Energy I²t Diagram, D Trip 1 pole

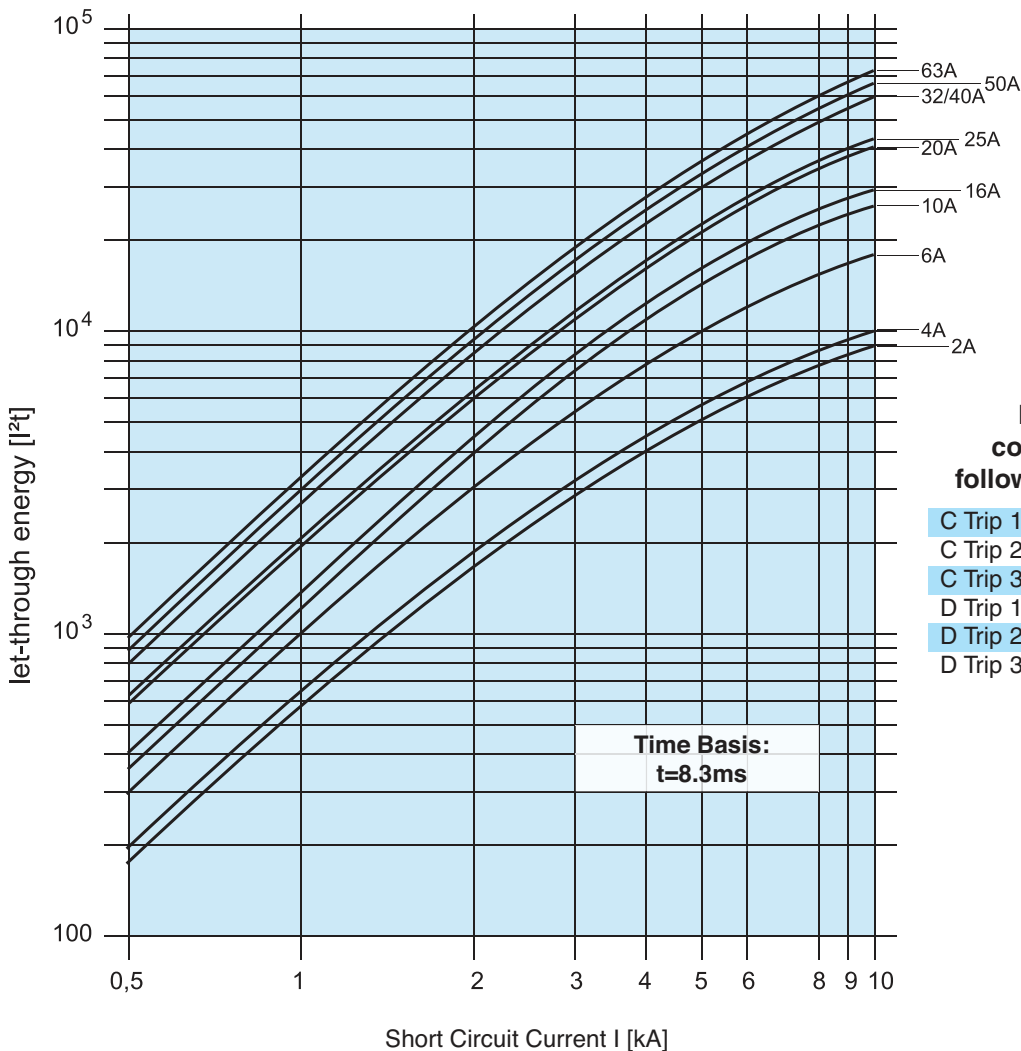

UL 489

UL 508

UL 1077

UL 1077
Equipment Breakers

Earth Leakage
Circuit Breakers

ANNEX

UM (V-EA) Series

UL508 Listed Manual Motor Controllers “Suitable as Motor Disconnect”



- DIN Rail Mounted
- 17.5mm width per pole
- Thermal Magnetic
- 0.3-60A / 480Y/277V AC, 50/60Hz
- 10kA Short Circuit Withstand Capacity
- Applications Include:
 - AC Motor Starting, Across the Line
 - AC General Use
 - AC Resistance
 - AC Discharge Lamps (Ballast)
 - AC Incandescent Lamps (Tungsten)



E511762



300600

up to 25A
B,C,D curve

PENDING



Current/ Voltage Rating	0.3-60A/480Y/277V AC 0.3-25A: 1 pole - 42V DC; 2 Pole - 80V DC 30-60A: 1 pole - 24V DC; 2 Pole - 60V DC
Short Circuit Withstand Rating (UL/CSA - Ratings)	0.3-60A (RC): 10kA with UL-listed RK5 back-up fuse or MCCB
Group Short Circuit Withstand Rating (UL/CSA - Ratings)	0.3-10A (RC): 10kA; 12-60A (RC): 5kA no branch circuit protection required
Interrupting Capacity (VDE - Ratings)	0.3-63A (RC): 10kA
Calibration Temperature	40°C (104°F)
Operating Temperature	-25°C to 70°C (-13°F to 158°F)
Storage Temperature	-40°C to 70°C (-40°F to 158°F)
Terminal Size Acceptability	Top: 18-3 AWG; Bottom: 18-2 AWG
Terminal Torque (min/max)	2 Nm (17.7 lb.in.) / 2.5Nm (22.2 lb.in)
Horse Power Ratings	see page 46
Mechanical Endurance Ratings	see page 47
Vibration Resistance	> 15g according to DIN EN 60069-2-59 during a load with $I_1 = 1.05 \times I_N$
Degree of protection acc. IEC/EN 60529	IP20
Mounting Orientation	In any plane

Short Circuit Withstand Ratings for UM (V-EA) Manual Motor Controller

Trip Curve	Amp Range	Backup Protection	UL-Listed RK5-Fuse up to 10kA	UL-Listed MCCB up to 10kA	No BCP Required up to:
all	0.3 - 10A		4xRC* min 15A, max 70A	4xRC* min 15A, max 70A	10kA
all	12 - 30/32A		4xRC* max 125A	4xRC* max 125A	5kA
all	40 - 50A		4xRC* max 200A	4xRC* max 200A	5kA
all	60 / 63A		4xRC* max 250A	4xRC* max 250A	5kA

*up to nearest rated current

Marking Details

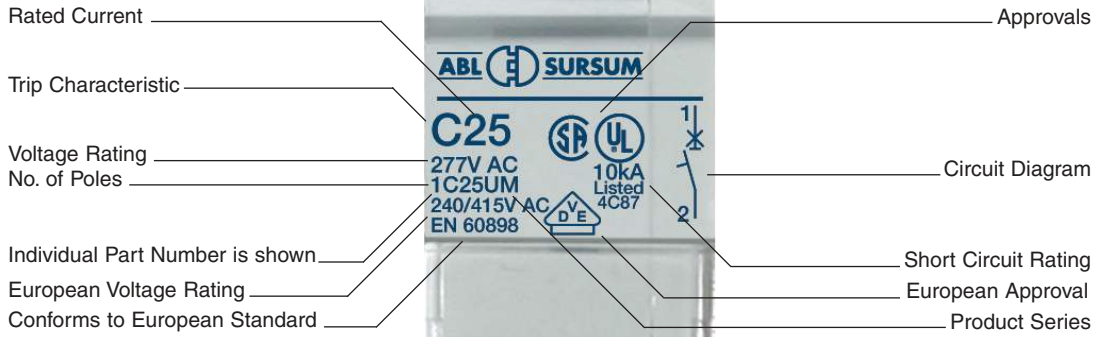

Dimensions in mm

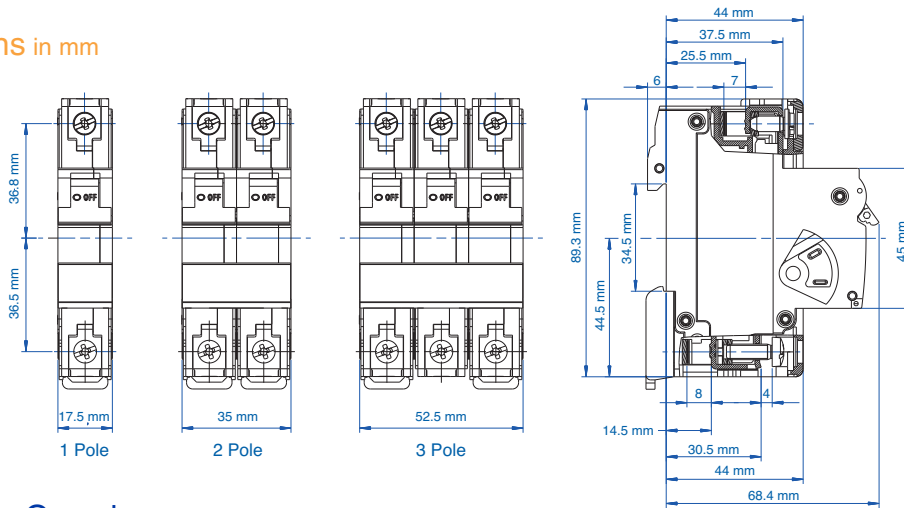

Application Overview

Trip-Characteristics*				Applications											
Characteristic Trip Boundaries				Lighting Wiring Protection Control Circuits	Business Equipment Appliances	Transformers	Power Supplies Heaters	Motors				General Electronics	Solenoid	Semi- conductors/ Components/ devices with low surge- current and short circuit withstand capabilities	Reactive Load
Thermal Trip		Magnetic Trip						General	Low Inrush	High Inrush	High Efficiency				
Must not Trip>100ms	Must Trip <1hr	Must not Trip>100ms	Must Trip at 100ms												
B-Characteristics															
1.13xRC	1.45xRC	3xRC	5xRC												
C-Characteristics															
1.13xRC	1.45xRC	5xRC	10xRC												
D-Characteristics															
1.13xRC	1.45xRC	10xRC	16xRC												
E-Characteristics															
1.05xRC	1.35xRC	14xRC	18xRC												
G-Characteristics															
1.05xRC	1.35xRC	8xRC	10xRC												
Z-Characteristics															
1.05xRC	1.35xRC	2xRC	3xRC												

*The value of each characteristic is shown vertically beneath its corresponding heading.



Warning!

This information should only be used as a selection guide. The use of a Miniature Circuit Breaker/Manual Motor Controller in an application with a certain Trip-Characteristic always requires prototype testing! It is the responsibility of the circuit design engineer to select the appropriate Miniature Circuit Breaker/Manual Motor Controller for his specific application.

V-EA Series B-Trip Characteristic

Application Examples:

Business equipment, wiring protection, lighting, appliances, control circuits, some motors and some electronic applications. Relatively long thermal trip delay but low magnetic trip point.



E511762



300600



upto 25A
B,C,D curve



One Pole

Rated Current	Type/ Voltage	Approvals
1.0A	1B1UM	UL SP
1.6A	1B1.6UM	UL SP
2.0A	1B2UM	UL SP
2.5A	1B2.5UM	UL SP
3.0A	1B3UM	UL SP
3.5A	1B3.5UM	UL SP
4.0A	1B4UM	UL SP
5.0A	1B5UM	UL SP
6.0A	1B6UM	UL SP
10A	1B10UM	UL SP
13A	1B13UM	UL SP
15A	1B15UM	UL SP
16A	1B16UM	UL SP
20A	1B20UM	UL SP
25A	1B25UZ	UL SP
30A	1B30UM	UL SP
32A	1B32UM	UL SP
40A	1B40UM	UL SP
50A	1B50UM	UL SP
60A	1B60UM	UL SP
63A	1B63UM	UL SP

Standard Pack: 12

Weight:

0.3A - 32A

1.75kg (3.86 lb.)

40A - 63A

2.07kg (4.56 lb.)



Three Pole

Rated Current	Type/ Cat. No.	Approvals
1.0A	3B1UM	UL SP
1.6A	3B1.6UM	UL SP
2.0A	3B2UM	UL SP
2.5A	3B2.5UM	UL SP
3.0A	3B3UM	UL SP
3.5A	3B3.5UM	UL SP
4.0A	3B4UM	UL SP
5.0A	3B5UM	UL SP
6.0A	3B6UM	UL SP
10A	3B10UM	UL SP
13A	3B13UM	UL SP
15A	3B15UM	UL SP
16A	3B16UM	UL SP
20A	3B20UM	UL SP
25A	3B25UM	UL SP
30A	3B30UM	UL SP
32A	3B32UM	UL SP
40A	3B40UM	UL SP
50A	3B50UM	UL SP
60A	3B60UM	UL SP
63A	3B63UM	UL SP

Standard Pack: 4

Weight:

0.3A - 32A

1.75kg (3.86 lb.)

40A - 63A

2.07kg (4.56 lb.)



Two Pole

Rated Current	Type/ Cat. No.	Approvals
1.0A	2B1UM	UL SP
1.6A	2B1.6UM	UL SP
2.0A	2B2UM	UL SP
2.5A	2B2.5UM	UL SP
3.0A	2B3UM	UL SP
3.5A	2B3.5UM	UL SP
4.0A	2B4UM	UL SP
5.0A	2B5UM	UL SP
6.0A	2B6UM	UL SP
10A	2B10UM	UL SP
13A	2B13UM	UL SP
15A	2B15UM	UL SP
16A	2B16UM	UL SP
20A	2B20UM	UL SP
25A	2B25UM	UL SP
30A	2B30UM	UL SP
32A	2B32UM	UL SP
40A	2B40UM	UL SP
50A	2B50UM	UL SP
60A	2B60UM	UL SP
63A	2B63UM	UL SP

Standard Pack: 6

Weight:

0.3A - 32A

1.75kg (3.86 lb.)

40A - 63A

2.07kg (4.56 lb.)



Add-on Neutral Pole

Rated Current	Type/ Cat. No.	Approvals
0.3-63A/ 480Y/277V	N63UM	UL SP

Standard Pack: 6

Weight:

0.775kg (1.71lb.)

V-EA Series C-Trip Characteristic

Application Examples:

Low inrush motors, lighting, wiring protection, appliances, business equipment, and control circuit applications. Relatively long thermal trip delay and medium magnetic trip point.



E511762



300600



upto 25A
B,C,D curve

UL 489

UL 508

UL 1077

UL 1077
Equipment Breakers

Earth Leakage
Circuit Breakers

ANNEX

One Pole



Standard Pack: 12

Weight:

0.3A - 32A

1.75kg (3.86 lb.)

40A - 63A

2.07kg (4.56 lb.)

Rated Current	Type/ Cat. No.	Approvals
0.3A	1C03UM	UL SP
0.5A	1C05UM	UL SP
0.75A	1C075UM	UL SP
1.0A	1C1UM	UL SP
1.6A	1C1.6UM	UL SP
2.0A	1C2UM	UL SP
2.5A	1C2.5UM	UL SP
3.0A	1C3UM	UL SP
3.5A	1C3.5UM	UL SP
4.0A	1C4UM	UL SP
5.0A	1C5UM	UL SP
6.0A	1C6UM	UL SP
8.0A	1C8UM	UL SP
10A	1C10UM	UL SP
13A	1C13UM	UL SP
15A	1C15UM	UL SP
16A	1C16UM	UL SP
20A	1C20UM	UL SP
25A	1C25UM	UL SP
30A	1C30UM	UL SP
32A	1C32UM	UL SP
40A	1C40UM	UL SP
50A	1C50UM	UL SP
60A	1C60UM	UL SP
63A	1C63UM	UL SP



Standard Pack: 4

Weight:

0.3A - 32A

1.75kg (3.86 lb.)

40A - 63A

2.07kg (4.56 lb.)

Three Pole

Rated Current	Type/ Cat. No.	Approvals
0.3A	3C03UM	UL SP
0.5A	3C05UM	UL SP
0.75A	3C075UM	UL SP
1.0A	3C1UM	UL SP
1.6A	3C1.6UM	UL SP
2.0A	3C2UM	UL SP
2.5A	3C2.5UM	UL SP
3.0A	3C3UM	UL SP
3.5A	3C3.5UM	UL SP
4.0A	3C4UM	UL SP
5.0A	3C5UM	UL SP
6.0A	3C6UM	UL SP
8.0A	3C8UM	UL SP
10A	3C10UM	UL SP
13A	3C13UM	UL SP
15A	3C15UM	UL SP
16A	3C16UM	UL SP
20A	3C20UM	UL SP
25A	3C25UM	UL SP
30A	3C30UM	UL SP
32A	3C32UM	UL SP
40A	3C40UM	UL SP
50A	3C50UM	UL SP
60A	3C60UM	UL SP
63A	3C63UM	UL SP

Two Pole



Standard Pack: 6

Weight:

0.3A - 32A

1.75kg (3.86 lb.)

40A - 63A

2.07kg (4.56 lb.)

Rated Current	Type/ Cat. No.	Approvals
0.3A	2C03UM	UL SP
0.5A	2C05UM	UL SP
0.75A	2C075UM	UL SP
1.0A	2C1UM	UL SP
1.6A	2C1.6UM	UL SP
2.0A	2C2UM	UL SP
2.5A	2C2.5UM	UL SP
3.0A	2C3UM	UL SP
3.5A	2C3.5UM	UL SP
4.0A	2C4UM	UL SP
5.0A	2C5UM	UL SP
6.0A	2C6UM	UL SP
8.0A	2C8UM	UL SP
10A	2C10UM	UL SP
13A	2C13UM	UL SP
15A	2C15UM	UL SP
16A	2C16UM	UL SP
20A	2C20UM	UL SP
25A	2C25UM	UL SP
30A	2C30UM	UL SP
32A	2C32UM	UL SP
40A	2C40UM	UL SP
50A	2C50UM	UL SP
60A	2C60UM	UL SP
63A	2C63UM	UL SP



Add-on Neutral Pole

Rated Current	Type/ Cat. No.	Approvals
0.3-63A/ 480Y/277V	N63UM	UL SP

Standard Pack: 6

Weight:

0.775kg (1.71lb.)

V-EA Series D-Trip Characteristic

Application Examples:

High inrush motors, transformers, power supplies, heaters and reactive loads. Relatively long thermal trip delay and very high magnetic trip point.



One Pole



Standard Pack: 12

Weight:

0.3A - 32A

1.75kg (3.86 lb.)

40A - 63A

2.07kg (4.56 lb.)

Rated Current	Type/ Cat. No.	Approvals
0.3A	1D03UM	UL SP
0.5A	1D05UM	UL SP
0.75A	1D075UM	UL SP
1.0A	1D1UM	UL SP
1.6A	1D1.6UM	UL SP
2.0A	1D2UM	UL SP
2.5A	1D2.5UM	UL SP
3.0A	1D3UM	UL SP
3.5A	1D3.5UM	UL SP
4.0A	1D4UM	UL SP
5.0A	1D5UM	UL SP
6.0A	1D6UM	UL SP
8.0A	1D8UM	UL SP
10A	1D10UM	UL SP
13A	1D13UM	UL SP
15A	1D15UM	UL SP
16A	1D16UM	UL SP
20A	1D20UM	UL SP
25A	1D25UM	UL SP
30A	1D30UM	UL SP
32A	1D32UM	UL SP
40A	1D40UM	UL SP
50A	1D50UM	UL SP
60A	1D60UM	UL SP
63A	1D63UM	UL SP

Three Pole



Standard Pack: 4

Weight:

0.3A - 32A

1.75kg (3.86 lb.)

40A - 63A

2.07kg (4.56 lb.)

Rated Current	Type/ Cat. No.	Approvals
0.3A	3D03UM	UL SP
0.5A	3D05UM	UL SP
0.75A	3D075UM	UL SP
1.0A	3D1UM	UL SP
1.6A	3D1.6UM	UL SP
2.0A	3D2UM	UL SP
2.5A	3D2.5UM	UL SP
3.0A	3D3UM	UL SP
3.5A	3D3.5UM	UL SP
4.0A	3D4UM	UL SP
5.0A	3D5UM	UL SP
6.0A	3D6UM	UL SP
8.0A	3D8UM	UL SP
10A	3D10UM	UL SP
13A	3D13UM	UL SP
15A	3D15UM	UL SP
16A	3D16UM	UL SP
20A	3D20UM	UL SP
25A	3D25UM	UL SP
30A	3D30UM	UL SP
32A	3D32UM	UL SP
40A	3D40UM	UL SP
50A	3D50UM	UL SP
60A	3D60UM	UL SP
63A	3D63UM	UL SP

Two Pole



Standard Pack: 6

Weight:

0.3A - 32A

1.75kg (3.86 lb.)

40A - 63A

2.07kg (4.56 lb.)

Rated Current	Type/ Cat. No.	Approvals
0.3A	2D03UM	UL SP
0.5A	2D05UM	UL SP
0.75A	2D075UM	UL SP
1.0A	2D1UM	UL SP
1.6A	2D1.6UM	UL SP
2.0A	2D2UM	UL SP
2.5A	2D2.5UM	UL SP
3.0A	2D3UM	UL SP
3.5A	2D3.5UM	UL SP
4.0A	2D4UM	UL SP
5.0A	2D5UM	UL SP
6.0A	2D6UM	UL SP
8.0A	2D8UM	UL SP
10A	2D10UM	UL SP
13A	2D13UM	UL SP
15A	2D15UM	UL SP
16A	2D16UM	UL SP
20A	2D20UM	UL SP
25A	2D25UM	UL SP
30A	2D30UM	UL SP
32A	2D32UM	UL SP
40A	2D40UM	UL SP
50A	2D50UM	UL SP
60A	2D60UM	UL SP
63A	2D63UM	UL SP

Add-on Neutral Pole



Rated Current	Type/ Cat. No.	Approvals
0.3-63A/ 480Y/277V	N63UM	UL SP

Standard Pack: 6

Weight:

0.775kg (1.71lb.)

V-EA Series E-Trip Characteristic

Application Examples:

High efficiency motors, which have exceedingly high inrush currents. Relatively short thermal trip delays and very high magnetic trip points.



Standard Pack: 12

Weight:

0.3A - 32A
1.75kg (3.86 lb.)
40A - 63A
2.07kg (4.56 lb.)

One Pole

Rated Current	Type/ Cat. No.	Approvals
0.3A	1E03UM	UL SP
0.5A	1E05UM	UL SP
0.75A	1E075UM	UL SP
1.0A	1E1UM	UL SP
1.6A	1E1.6UM	UL SP
2.0A	1E2UM	UL SP
2.5A	1E2.5UM	UL SP
3.0A	1E3UM	UL SP
3.5A	1E3.5UM	UL SP
4.0A	1E4UM	UL SP
5.0A	1E5UM	UL SP
6.0A	1E6UM	UL SP
8.0A	1E8UM	UL SP
10A	1E10UM	UL SP
12A	1E12UM	UL SP
13A	1E13UM	UL SP
15A	1E15UM	UL SP
16A	1E16UM	UL SP
20A	1E20UM	UL SP
25A	1E25UM	UL SP
30A	1E30UM	UL SP
32A	1E32UM	UL SP
40A	1E40UM	UL SP
50A	1E50UM	UL SP
60A	1E60UM	UL SP
63A	1E63UM	UL SP



Standard Pack: 4

Weight:

0.3A - 32A
1.75kg (3.86 lb.)
40A - 63A
2.07kg (4.56 lb.)

Three Pole

Rated Current	Type/ Cat. No.	Approvals
0.3A	3E03UM	UL SP
0.5A	3E05UM	UL SP
0.75A	3E075UM	UL SP
1.0A	3E1UM	UL SP
1.6A	3E1.6UM	UL SP
2.0A	3E2UM	UL SP
2.5A	3E2.5UM	UL SP
3.0A	3E3UM	UL SP
3.5A	3E3.5UM	UL SP
4.0A	3E4UM	UL SP
5.0A	3E5UM	UL SP
6.0A	3E6UM	UL SP
8.0A	3E8UM	UL SP
10A	3E10UM	UL SP
12A	3E12UM	UL SP
13A	3E13UM	UL SP
15A	3E15UM	UL SP
16A	3E16UM	UL SP
20A	3E20UM	UL SP
25A	3E25UM	UL SP
30A	3E30UM	UL SP
32A	3E32UM	UL SP
40A	3E40UM	UL SP
50A	3E50UM	UL SP
60A	3E60UM	UL SP
63A	3E63UM	UL SP



Standard Pack: 6

Weight:

0.3A - 32A
1.75kg (3.86 lb.)
40A - 63A
2.07kg (4.56 lb.)

Two Pole

Rated Current	Type/ Cat. No.	Approvals
0.3A	2E03UM	UL SP
0.5A	2E05UM	UL SP
0.75A	2E075UM	UL SP
1.0A	2E1UM	UL SP
1.6A	2E1.6UM	UL SP
2.0A	2E2UM	UL SP
2.5A	2E2.5UM	UL SP
3.0A	2E3UM	UL SP
3.5A	2E3.5UM	UL SP
4.0A	2E4UM	UL SP
5.0A	2E5UM	UL SP
6.0A	2E6UM	UL SP
8.0A	2E8UM	UL SP
10A	2E10UM	UL SP
12A	2E12UM	UL SP
13A	2E13UM	UL SP
15A	2E15UM	UL SP
16A	2E16UM	UL SP
20A	2E20UM	UL SP
25A	2E25UM	UL SP
30A	2E30UM	UL SP
32A	2E32UM	UL SP
40A	2E40UM	UL SP
50A	2E50UM	UL SP
60A	2E60UM	UL SP
63A	2E63UM	UL SP



Add-on Neutral Pole

Rated Current	Type/ Cat. No.	Approvals
0.3-63A/ 480Y/277V	N63UM	UL SP

Standard Pack: 6

Weight:

0.775kg (1.71lb.)

UL 489

UL 508

UL 1077

UL 1077
Equipment Breakers

Earth Leakage
Circuit Breakers

ANNEX

V-EA Series

G-Trip

Characteristic

Application Examples:

General industrial, including motors, some transformers, solenoids, control circuits, lighting and wiring. Meets the US trip norms with relatively short thermal trip delay and high magnetic trip point.



E511762 300600



One Pole

Rated Current	Type/ Cat. No.	Approvals
0.3A	1G03UM	UL SP
0.5A	1G05UM	UL SP
0.8A	1G08UM	UL SP
1.0A	1G1UM	UL SP
1.6A	1G1.6UM	UL SP
2.0A	1G2UM	UL SP
2.5A	1G2.5UM	UL SP
3.0A	1G3UM	UL SP
3.5A	1G3.5UM	UL SP
4.0A	1G4UM	UL SP
5.0A	1G5UM	UL SP
6.0A	1G6UM	UL SP
8.0A	1G8UM	UL SP
10A	1G10UM	UL SP
12A	1G12UM	UL SP
13A	1G13UM	UL SP
15A	1G15UM	UL SP
16A	1G16UM	UL SP
20A	1G20UM	UL SP
25A	1G25UM	UL SP
30A	1G30UM	UL SP
32A	1G32UM	UL SP
40A	1G40UM	UL SP
50A	1G50UM	UL SP
60A	1G60UM	UL SP
63A	1G63UM	UL SP

Standard Pack: 12

Weight:

0.3A - 32A

1.75kg (3.86 lb.)

40A - 63A

2.07kg (4.56 lb.)



Three Pole

Rated Current	Type/ Cat. No.	Approvals
0.3A	3G03UM	UL SP
0.5A	3G05UM	UL SP
0.8A	3G08UM	UL SP
1.0A	3G1UM	UL SP
1.6A	3G1.6UM	UL SP
2.0A	3G2UM	UL SP
2.5A	3G2.5UM	UL SP
3.0A	3G3UM	UL SP
3.5A	3G3.5UM	UL SP
4.0A	3G4UM	UL SP
5.0A	3G5UM	UL SP
6.0A	3G6UM	UL SP
8.0A	3G8UM	UL SP
10A	3G10UM	UL SP
12A	3G12UM	UL SP
13A	3G13UM	UL SP
15A	3G15UM	UL SP
16A	3G16UM	UL SP
20A	3G20UM	UL SP
25A	3G25UM	UL SP
30A	3G30UM	UL SP
32A	3G32UM	UL SP
40A	3G40UM	UL SP
50A	3G50UM	UL SP
60A	3G60UM	UL SP
63A	3G63UM	UL SP

Standard Pack: 4

Weight:

0.3A - 32A

1.75kg (3.86 lb.)

40A - 63A

2.07kg (4.56 lb.)



Two Pole

Rated Current	Type/ Cat. No.	Approvals
0.3A	2G03UM	UL SP
0.5A	2G05UM	UL SP
0.8A	2G08UM	UL SP
1.0A	2G1UM	UL SP
1.6A	2G1.6UM	UL SP
2.0A	2G2UM	UL SP
2.5A	2G2.5UM	UL SP
3.0A	2G3UM	UL SP
3.5A	2G3.5UM	UL SP
4.0A	2G4UM	UL SP
5.0A	2G5UM	UL SP
6.0A	2G6UM	UL SP
8.0A	2G8UM	UL SP
10A	2G10UM	UL SP
12A	2G12UM	UL SP
13A	2G13UM	UL SP
15A	2G15UM	UL SP
16A	2G16UM	UL SP
20A	2G20UM	UL SP
25A	2G25UM	UL SP
30A	2G30UM	UL SP
32A	2G32UM	UL SP
40A	2G40UM	UL SP
50A	2G50UM	UL SP
60A	2G60UM	UL SP
63A	2G63UM	UL SP

Standard Pack: 6

Weight:

0.3A - 32A

1.75kg (3.86 lb.)

40A - 63A

2.07kg (4.56 lb.)



Add-on Neutral Pole

Rated Current	Type/ Cat. No.	Approvals
0.3-63A/ 480Y/277V	N63UM	UL SP

Standard Pack: 6

Weight:

0.775kg (1.71lb.)

V-EA Series Z-Trip Characteristic

Application Examples:

Semiconductors, components which fail-short (vs. fail-open), and components/devices with low surge-current and short circuit withstand capabilities. Relatively short thermal delay and very low magnetic trip point.



E511762



300600

UL 489

UL 508

UL 1077

UL 1077
Equipment Breakers

Earth Leakage
Circuit Breakers

ANNEX

One Pole



Standard Pack: 12

Weight:

0.3A - 32A

1.75kg (3.86 lb.)

40A - 63A

2.07kg (4.56 lb.)

Rated Current	Type/ Cat. No.	Approvals
0.3A	1Z03UM	UL SF
0.5A	1Z05UM	UL SF
0.75A	1Z075UM	UL SF
1.0A	1Z1UM	UL SF
1.6A	1Z1.6UM	UL SF
2.0A	1Z2UM	UL SF
2.5A	1Z2.5UM	UL SF
3.0A	1Z3UM	UL SF
3.5A	1Z3.5UM	UL SF
4.0A	1Z4UM	UL SF
5.0A	1Z5UM	UL SF
6.0A	1Z6UM	UL SF
8.0A	1Z8UM	UL SF
10A	1Z10UM	UL SF
12A	1Z12UM	UL SF
13A	1Z13UM	UL SF
15A	1Z15UM	UL SF
16A	1Z16UM	UL SF
20A	1Z20UM	UL SF
25A	1Z25UM	UL SF
30A	1Z30UM	UL SF
32A	1Z32UM	UL SF
40A	1Z40UM	UL SF
50A	1Z50UM	UL SF



Standard Pack: 4

Weight:

0.3A - 32A

1.75kg (3.86 lb.)

40A - 63A

2.07kg (4.56 lb.)

Three Pole

Rated Current	Type/ Cat. No.	Approvals
0.3A	3Z03UM	UL SF
0.5A	3Z05UM	UL SF
0.75A	3Z075UM	UL SF
1.0A	3Z1UM	UL SF
1.6A	3Z1.6UM	UL SF
2.0A	3Z2UM	UL SF
2.5A	3Z2.5UM	UL SF
3.0A	3Z3UM	UL SF
3.5A	3Z3.5UM	UL SF
4.0A	3Z4UM	UL SF
5.0A	3Z5UM	UL SF
6.0A	3Z6UM	UL SF
8.0A	3Z8UM	UL SF
10A	3Z10UM	UL SF
12A	3Z12UM	UL SF
13A	3Z13UM	UL SF
15A	3Z15UM	UL SF
16A	3Z16UM	UL SF
20A	3Z20UM	UL SF
25A	3Z25UM	UL SF
30A	3Z30UM	UL SF
32A	3Z32UM	UL SF
40A	3Z40UM	UL SF
50A	3Z50UM	UL SF

Two Pole



Standard Pack: 6

Weight:

0.3A - 32A

1.75kg (3.86 lb.)

40A - 63A

2.07kg (4.56 lb.)

Rated Current	Type/ Cat. No.	Approvals
0.3A	2Z03UM	UL SF
0.5A	2Z05UM	UL SF
0.75A	2Z075UM	UL SF
1.0A	2Z1UM	UL SF
1.6A	2Z1.6UM	UL SF
2.0A	2Z2UM	UL SF
2.5A	2Z2.5UM	UL SF
3.0A	2Z3UM	UL SF
3.5A	2Z3.5UM	UL SF
4.0A	2Z4UM	UL SF
5.0A	2Z5UM	UL SF
6.0A	2Z6UM	UL SF
8.0A	2Z8UM	UL SF
10A	2Z10UM	UL SF
12A	2Z12UM	UL SF
13A	2Z13UM	UL SF
15A	2Z15UM	UL SF
16A	2Z16UM	UL SF
20A	2Z20UM	UL SF
25A	2Z25UM	UL SF
30A	2Z30UM	UL SF
32A	2Z32UM	UL SF
40A	2Z40UM	UL SF
50A	2Z50UM	UL SF



Add-on Neutral Pole

Rated Current	Type/ Cat. No.	Approvals
0.3-63A/ 480Y/277V	N63UM	UL SF

Standard Pack: 6

Weight:

0.775kg (1.71 lb.)

V-EA Trip Curves

B Trip Curve

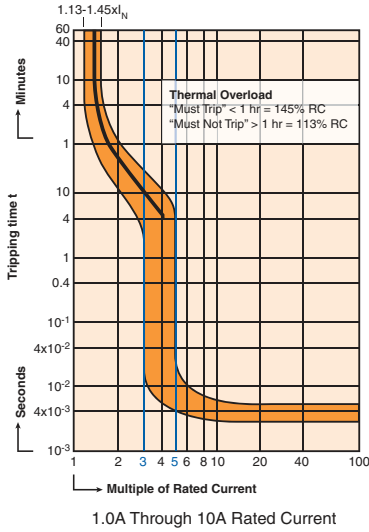

C Trip Curve

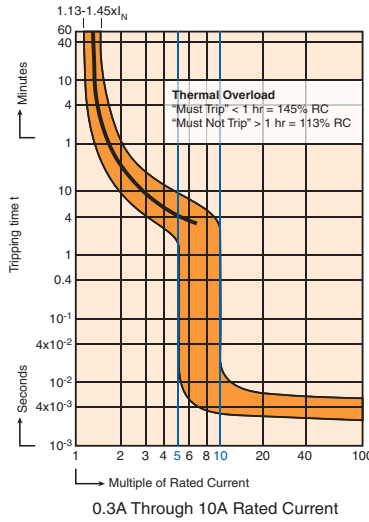

D Trip Curve

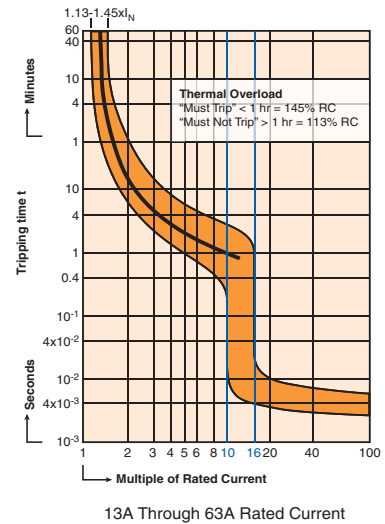
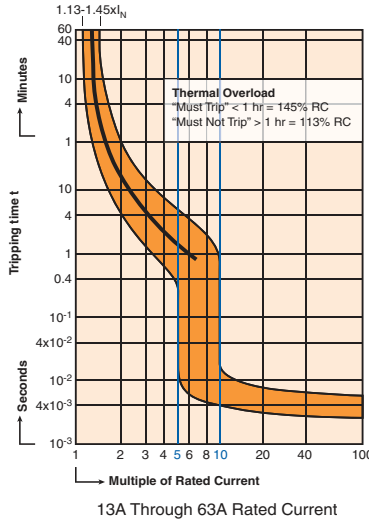
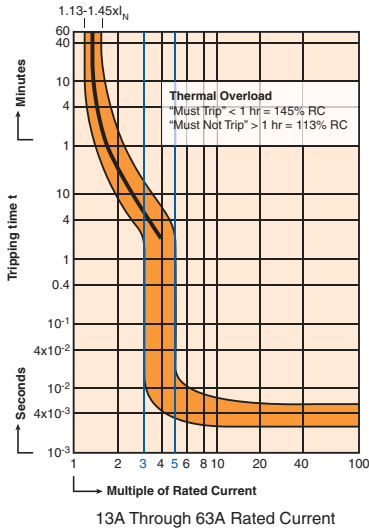
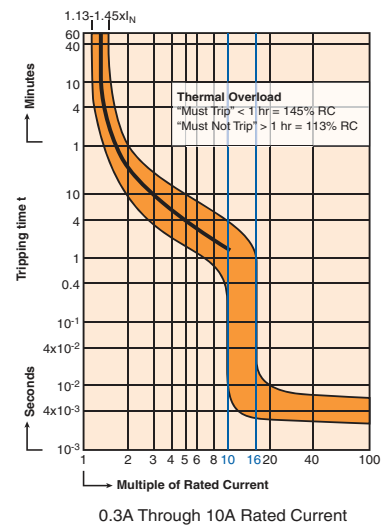

“B” Magnetic Trip Parameters

Rated current 1.0A to 63A.

1. Hold for a minimum of 100ms at surge of 3 times rated current.
2. Trip in under 100ms at 5 times rated current.

“C” Magnetic Trip Parameters

Rated current 0.3A to 63A.

1. Hold for a minimum of 100ms at surge of 5 times rated current.
2. Trip in under 100ms at 10 times rated current.

“D” Magnetic Trip Parameters

Rated current 0.3A to 63A.

1. Hold for a minimum of 100ms at surge of 10 times rated current.
2. Trip in under 100ms at 16 times rated current.

V-EA Trip Curves

E Trip Curve

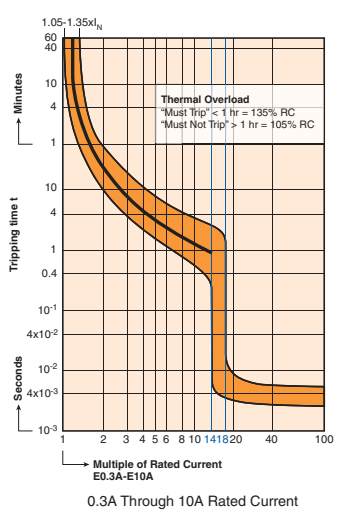

G Trip Curve

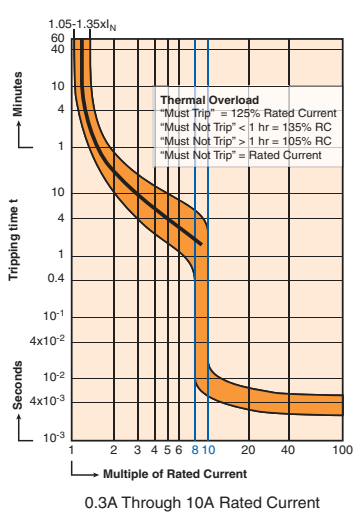

Z Trip Curve

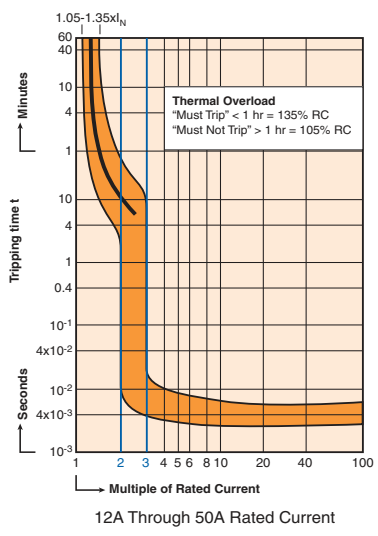
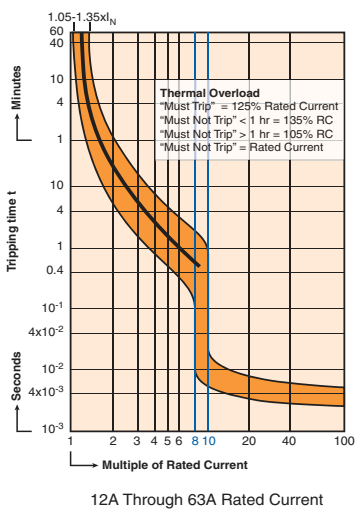
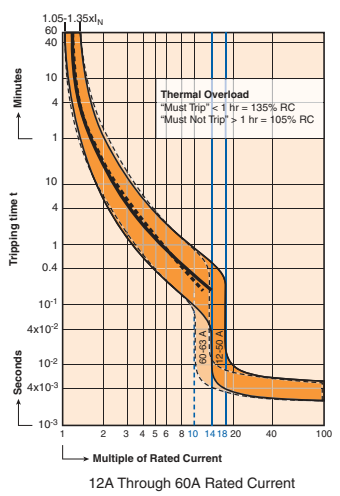
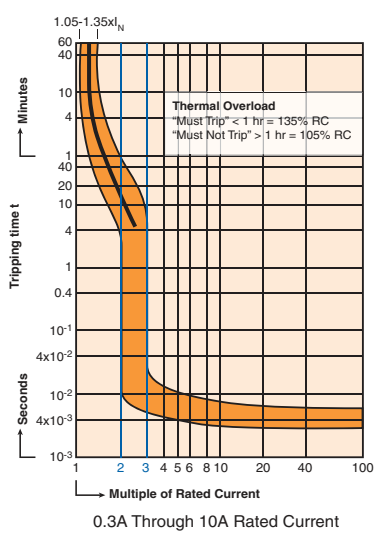

"E" Magnetic Trip Parameters
 Rated Current, 0.3A to 50A,
 60/63A (dotted line).

- Magnetic Trip:**
1. Hold for a minimum of 100ms at surge of 14 times (60A, 10 times) rated current.
 2. Trip in under 100ms at 18 times (60A, 14 times) rated current.

"G" Magnetic Trip Parameters
 Rated Current, 0.3A to 63A.

- Magnetic Trip:**
1. Hold for a minimum of 100ms at surge of 8 times rated current.
 2. Trip in under 100ms at 10 times rated current.

"Z" Trip Parameters
 Rated Current, 0.3A to 50A.

- Magnetic Trip:**
1. Hold for a minimum of 100ms at 2 times rated current.
 2. Trip in under 100ms at 3 times rated current.

Table HP 1: AMPERE RATINGS & HORSEPOWER RATING 1 PHASE

			FLA & LRC CONVERTED TO TABLE HORSEPOWER (SEE NOTE #2) USE FLA & LRC RATINGS WHERE NO HP RATING IS GIVEN					
			NOMINAL CIRCUIT VOLTAGE					
V-EA RATED	MOTOR NAMEPLATE	MOTOR NAMEPLATE	110-120 VAC	200 VAC	208 VAC	220-240 VAC	265 VAC	277 VAC
CURRENT (SEE NOTE #1)	FLA RATING	STARTING/ LRC RATING						
0.30A 0.50A 0.75A	0.30A 0.50A 0.75A	1.80A 3.00A 4.35A						
0.80A 1.0A 1.6A	0.80A 1.0A 1.6A	4.8A 6.0A 9.6A						
2.0A 2.5A 3.0A	2.0A 2.5A 3.0A	12.0A 15.0A 18.0A		1/6hp 1/6hp	1/6hp 1/6hp	1/6hp 1/6hp 1/4hp	1/6hp 1/6hp 1/4hp	1/6hp 1/4hp 1/3hp
3.5A 4.0A	3.5A 4.0A	21.0A 24.0A		1/4hp 1/4hp	1/4hp 1/3hp	1/4hp 1/3hp	1/3hp 1/3hp	1/3hp 1/3hp
5.0A 6.0A 8.0A	5.0A 6.0A 8.0A	30.0A 36.0A 48.0A	1/6hp 1/4hp 1/3hp	1/3hp 1/2hp 3/4hp	1/2hp 1/2hp 3/4hp	1/2hp 1/2hp 1hp	1/2hp 3/4hp 1hp	1/2hp 3/4hp 1hp
10.0A	10.0A	60.0A	1/2hp	1hp	1hp	11/2hp	11/2hp	2hp
12.0A 12.5A	12.0A 12.5A	72.0A 75.0A	1/2hp 1/2hp	11/2hp 11/2hp	11/2hp 11/2hp	2hp 2hp	2hp 2hp	2hp 2hp
13.0A 15.0A 16.0A	13.0A 15.0A 16.0A	78.0A 90.0A 96.0A	1/2hp 3/4hp 1hp	11/2hp 2hp 2hp	11/2hp 2hp 2hp	2hp 2hp 2hp	2hp 3hp 3hp	2hp 3hp 3hp
20.0A 25.0A	20.0A 25.0A	120.0A 150.0A	11/2hp 2hp	3hp 3hp	3hp 3hp	3hp 3hp	3hp 5hp	3hp 5hp
30.0A	30.0A	180.0A	2hp	3hp	3hp	5hp	5hp	5hp
32.0A	32.0A	192.0A	2hp	3hp	5hp	5hp	5hp	5hp
40.0A	40.0A	240.0A	3hp	5hp	71/2hp	71/2hp	71/2hp	71/2hp
50.0A 60.0A	50.0A 60.0A	300.0A 360.0A	3hp 5hp	71/2hp 10hp	10hp 10hp	10hp 10hp	10hp 10hp	10hp 15hp

NOTE #1: For AC motor circuit nameplate full load current, AC general-use loads, AC resistance loads, AC incandescent lamp (tungsten) loads, AC electric discharge lamp (ballast) loads.
NOTE #2: Conversions per UL508® Table 45.2 and NFPA-70: National Electrical Code® 2011 Tables 430-248 and 430-251(A).

TABLE HP 2: AMPERE RATING & HORSEPOWER RATING 3 PHASE & 2 PHASE - 4 WIRE

FLA & LRC RATINGS CONVERTED TO TABLE HORSEPOWER (SEE NOTE #2) USE FLA & LRC RATINGS WHERE NO HP IS LISTED													
V-EA RATED CURRENT (SEE NOTE #1)	MOTOR NAMEPLATE FLA RATING	MOTOR NAMEPLATE STARTING/ LRC RATING	110-120 VAC		200 VAC		208 VAC		220-240 VAC (SEE NOTE #3)		440-480 VAC		
			Motor Design		Motor Design		Motor Design		Motor Design		Motor Design		
			B, C, D	E	B, C, D	E	B, C, D	E	B, C, D	E	B, C, D	E	
0.30A 0.50A 0.75A	0.30A 0.50A 0.75A	3.0A 5.0A 7.5A											
0.80A 1.0A 1.6A	0.80A 1.0A 1.6A	8.0A 10.0A 16.0A										1/2hp	1/2hp
2.0A 2.5A 3.0A	2.0A 2.5A 3.0A	20.0A 25.0A 30.0A			1/2hp 1/2hp	1/2hp 1/2hp	1/2hp 1/2hp	1/2hp 1/2hp	1/2hp 1/2hp 1/2hp	1/2hp 1/2hp 1/2hp	1/2hp 1/2hp 1/2hp	11/2hp	11/2hp
3.5A 4.0A	3.5A 4.0A	35.0A 40.0A			1/2hp 3/4hp	1/2hp 3/4hp	3/4hp 3/4hp	3/4hp 3/4hp	3/4hp 3/4hp	3/4hp 3/4hp	3/4hp 3/4hp	2hp	2hp
5.0A 6.0A 8.0A	5.0A 6.0A 8.0A	42.0A 50.4A 67.2A	1/2hp 1/2hp 3/4hp	1/2hp 1/2hp 3/4hp	1hp 1hp 2hp	1hp 1hp 2hp	1hp 1hp 2hp	1hp 1hp 2hp	1hp 11/2hp 2hp	1hp 11/2hp 2hp	3hp 3hp 5hp	3hp 3hp 5hp	
10.0A 12.0A 12.5A	10.0A 12.0A 12.5A	84.0A 100.8A 105.0A	1hp 11/2hp 11/2hp	1hp 11/2hp 11/2hp	2hp 3hp 3hp	2hp 3hp 3hp	2hp 3hp 3hp	2hp 3hp 3hp	3hp 3hp 3hp	3hp 3hp 3hp	3hp 3hp 3hp	5hp 71/2hp 71/2hp	5hp 71/2hp 71/2hp
13.0A 15.0A 16.0A	13.0A 15.0A 16.0A	109.2A 126.0A 134.4A	11/2hp 2hp 2hp	11/2hp 2hp 2hp	3hp 3hp 3hp	3hp 3hp 3hp	3hp 3hp 3hp	3hp 3hp 3hp	3hp 3hp 5hp	3hp 3hp 5hp	3hp 3hp 5hp	71/2hp 10hp 10hp	71/2hp 10hp 10hp
20.0A 25.0A	20.0A 25.0A	168.0A 210.0A	3hp 3hp	3hp 3hp	5hp 5hp	5hp 5hp	5hp 71/2hp	5hp 71/2hp	5hp 71/2hp	5hp 71/2hp	5hp 71/2hp	10hp 15hp	10hp 15hp
30.0A	30.0A	252.0A	5hp	5hp	5hp	5hp	71/2hp	71/2hp	10hp	10hp	20hp	20hp	
32.0A	32.0A	268.8A	5hp	5hp	5hp	5hp	10hp	10hp	10hp	10hp	20hp	20hp	
40.0A	40.0A	226.0A	5hp	5hp	10hp	71/2hp	10hp	71/2hp	10hp	10hp	30hp	20hp	
50.0A 60.0A	50.0A 60.0A	282.5A 339.0A	71/2hp 10hp	71/2hp 10hp	15hp 15hp	10hp 10hp	15hp 20hp	10hp 10hp	15hp 20hp	10hp 15hp	30hp 40hp	25hp 30hp	

NOTE #1: For AC motor circuit nameplate full load current, AC general-use loads, AC resistance loads, AC incandescent lamp (tungsten) loads, AC electric discharge lamp (ballast) loads.
NOTE #2: Conversions per UL508® proposed Tables 45.2 and 45.4 and NFPA-70: National Electrical Code® 2011 Tables 430-249, 430-250 and 430-251(B).

V-EA INTERNAL RESISTANCE

Rated Current (Amp)	Trip Characteristic					
	B (Ohms)	C (Ohms)	D (Ohms)	E (Ohms)	G (Ohms)	Z (Ohms)
0.3	—	16.8620	16.8620	14.52000	16.8620	31.5060
0.5	—	6.8540	6.0009	5.92000	6.8540	10.2460
0.75/0.8	—	3.0540	3.0540	2.70000	3.0540	5.3920
1.0	—	1.7000	1.7560	1.48000	1.7560	2.6910
1.6	—	0.5870	0.5870	0.57400	0.5870	0.9440
2.0	—	0.4190	0.4190	0.40500	0.4190	0.8900
2.5	—	0.2950	0.2950	0.26900	0.2950	0.4290
3.0	—	0.2020	0.2020	0.18600	0.2020	0.3460
3.5	—	0.1390	0.1390	0.13900	0.1390	0.1790
4.0	—	0.1090	0.1090	0.10600	0.1090	0.1620
5.0	—	0.0654	0.0654	0.05900	0.0654	0.1050
6.0	0.0528	0.0528	0.0491	0.04600	0.0491	0.0823
8.0	—	0.0278	0.0240	0.03040	0.0333	0.0371
10	0.0216	0.0216	0.0187	0.02020	0.0211	0.0278
12/12.5	—	—	—	0.00724	0.0084	0.0151
13	0.0113	0.0084	0.0085	0.00724	0.0084	0.0151
15/16	0.0085	0.0085	0.0076	0.00731	0.0076	0.0114
20	0.0067	0.0067	0.0064	0.00582	0.0064	0.0075
25	0.0050	0.0050	0.0041	0.00411	0.0046	0.0050
30/32	0.0032	0.0032	0.0027	0.00272	0.0030	0.0032
40	0.0025	0.0025	0.0022	0.00212	0.0022	0.0022
50	0.0019	0.0019	0.0018	0.00184	0.0019	0.00195
60/63	0.0018	0.0018	0.0017	0.00172	0.00179	—

Resistances listed are “hot” values, as opposed to cold start values. Operating voltage drop across the V-EA and power loss per pole can be approximated with basic formulas:

$$V_{DROP} = I_{OPERATING} \times R_{TABLE}$$

$$P_{LOSS P/P} = I_{OPERATING}^2 \times R_{TABLE}$$

Voltage drops should be reviewed when V-EAs with high internal resistance are used (e.g., load voltage minimums). Power loss should be reviewed when V-EAs with high rated currents are used (e.g., enclosure heating).

The listed V-EA internal resistance values should not be used in calculations of available short-circuit current downstream of the V-EA. The dynamic impedance of the V-EA under short-circuit conditions can vary significantly from internal resistance values in normal operation.

LINE CURRENT FREQUENCY EFFECTS ON TRIP CURVES

Frequency Effects on Magnetic Trip Curves					
Trip Curve	Trip Zone At 16 2/3 - 60Hz (x RC)	Trip Zone At 100 Hz (x RC)	Trip Zone At 200 Hz (x RC)	Trip Zone At 400 Hz (x RC)	Trip Zone At DC (x RC)
Z	2 - 3	2.2 - 3.3	2.4 - 3.6	2.8 - 4.2	3.0 - 4.5
B	3 - 5	3.3 - 5.5	3.6 - 6.0	4.2 - 7.0	4.5 - 7.5
C	5 - 10	5.5 - 11.0	6.0 - 12	7.0 - 14.0	7.5 - 15.0
G	8 - 10	8.8 - 11.0	9.6 - 12.0	11.2 - 14.0	12.0 - 15.0
D	10 - 16	11.0 - 17.6	12.0 - 19.2	14.0 - 22.4	15.0 - 24.0
E	14 - 18	15.4 - 19.8	16.8 - 21.6	19.6 - 25.2	21.0 - 27.0

The thermal trip is not affected by the frequency of the line current. The magnetic trip is within the trip zone of the characteristic curve for frequencies from 16 2/3 to 60Hz. At lower and higher frequencies, the magnetic trip will be delayed longer than indicated by the characteristic curve, roughly as follows:

- At 100Hz:** Mag. Trip Current = 1.1 x curve current
- At 200Hz:** Mag. Trip Current = 1.2 x curve current
- At 400Hz:** Mag. Trip Current = 1.4 x curve current
- At DC:** Mag. Trip Current = 1.5 x curve current

For example, at 16 2/3 - 60 Hz the magnetic trip zone for the “G” characteristic is 8 to 10 times the rated current of the specific V-EA (i.e., hold for at least 100ms at 8 x RC, trip in less than 100ms at 10 x RC). With a 400Hz current, a magnetic trip at 10 x RC would be greatly delayed (thermal would likely trip first), as the magnetic trip zone is now 11.2 to 14 x RC. If a quicker magnetic trip is required with 400Hz, the “B” or “C” characteristic should be considered.

MECHANICAL ENDURANCE RATINGS (ON/OFF OPERATIONS)

Application	2 x (1.15 x RC)	2 x RC	RC	No Load	Total
AC General Use	—	6,000	—	4,000	10,000
AC Motor Starting Across the Line	1,000	—	5,000	4,000	10,000
AC Incandescent Lamps (Tungsten)	—	—	6,000	4,000	10,000
AC Electrical Discharge Lamps (Ballast)	—	6,000	—	4,000	10,000
AC Resistance	—	6,000	—	4,000	10,000

Manufacturers self certification 20000 ON/OFF operations with no load

UL 489

UL 508

UL 1077

UL 1077
Equipment Breakers

Earth Leakage
Circuit Breakers

ANNEX

MA-Series

Three Phase Adjustable Trip Miniature Circuit Breakers/ Manual Motor Controllers



 E511762

 CAN/CSA-C22.2 No.14 certified

The MA was designed to handle the high inrush loads of 3 phase transformers, power supplies, motors, etc. The MA protects wiring and equipment from damage caused by the three major classes of over-current, yet greatly reduces the number of nuisance trips in high starting and inrush current circuits.

An IEC device with excellent ratings under a UL listing at 480Y/277V (including group ratings) and at 500V under international standards, the Altech/ABL Sursum MA provides short and long term cost effective circuit protection for USA and/or export applications. The short term advantages include: (1) adjustable thermal trip allows finalization of initial designs before procurement of the load equipment is complete; (2) snap-on mounting for readily available, internationally standardized DIN Rail saves panel layout design time as well as installation and change labor; (3) large cage-clamp terminals with screws suitable to power screwdrivers, simplifies and speeds wiring; (4) convenient switched disconnect during factory testing and/or initial start-up saves time and aggravation. The key long term advantage is customer satisfaction and proven over-current protection of wiring and equipment (and the lack of rework/repair costs).

Type Designation

MA	16	U	M
(a)	(b)	(c)	(d)

- (a) = MA - Manual Motor Controller
 (b) = Rated Current
 (c) = U - US Housing
 = R - US Housing + Ring Tongue
 (d) = M - Part No. Designation

Voltage Rating	480Y/277V AC
AIC (Interrupt Capacity)	0.16A-2.5A: 42kA; 4.0A-16A: 14kA; 20A-40A: 10kA
Standard Short Circuit Withstand Rating (UL/CSA Ratings)	0.16A-2.5A: 42kA; 4.0A-16A: 14kA; 20A-40A: 10kA
Group Short Circuit Ratings (UL/CSA Ratings)	see above
Typical Life	6,000 on/off operations with 2xRC
Calibration Temperature	25°C, +0°, -5° (77°F, +0° -9°)
Standard Pack and Weight	1/450g (1.0 lb.)
Terminal Size Acceptability	Top/Bottom: 18-3 AWG
Terminal Torque (min/max)	2 Nm (17.7 lb.in.) / 2.5Nm (22.2 lb.in)

Cat. No.	Rated Current	FLA Dial Adjustment Markings	GROUP SHORT CIRCUIT RATING AT 480VAC ^a (and BCP size)	3Ø HORSEPOWER RATINGS AT NOMINAL LINE VOLTAGE (See Note for HEA Definition)				
				110-120V HP (HEA)	200V HP (HEA)	208V HP (HEA)	220-240V HP (HEA)	460-480V HP (HEA)
MA016UM	0.16A	0.1/ 0.12/0.14/0.16	42kARMS symmetrical (max. 1200A MCCB or RK5)					
MA025UM	0.25A	0.16/0.19/0.22/0.25						
MA040UM	0.40A	0.25/0.30/0.35/0.40						
MA063UM	0.63A	0.40/0.48/0.56/0.63						
MA1.0UM	1.0A	0.63/0.75/0.87/1.0						
MA1.6UM	1.6A	1.0/1.2/1.4/1.6						
MA2.5UM	2.5A	1.6/1.9/2.2/2.5						
MA4.0UM	4.0A	2.5/3.0/3.5/4.0	14kARMS	1/2 (4.0)	3/4 (3.2)	3/4 (3.1)	1 (3.6)	2 (3.42)
MA6.3UM	6.3A	4.0/4.8/5.6/6.3	symmetrical (max. 350A MCCB or RK5)	3/4 (5.6)	1 1/2 (6.0)	1 1/2 (5.7)	1 1/2 (5.2)	3 (4.8)
MA10UM	10A	6.3/7.5/8.7/10		1 (7.2)	2 (7.8)	2 (7.5)	3 (9.6)	5 (7.6)
MA16UM	16A	10/12/14/16		2 (13.6)	3 (11.0)	3 (10.6)	5 (15.2)	10 (14.0)
MA20UM	20A	16/17/18.5/20	10kARMS	3 (19.2)	5 (17.5)	5 (16.7)	5 (15.2)	10 (14.0)
MA25UM	25A	20/21.5/23/25	symmetrical (max. 350A MCCB or RK5)	3 (19.2)	5 (17.5)	7 1/2 (24.2)	7 1/2 (22.0)	15 (21.0)
MA32UM	32A	25/27/30/32		5 (30.4)	7 1/2 (25.0)	7 1/2 (24.2)	10 (28.0)	20 (27.0)
MA40UM	40A	32/34/37/40		5 (30.4)	10 (32.0)	10 (31.0)	10 (28.0)	25 (34.0)

Note: HEA - Horsepower Equivalent Amperes, the nominal amperage assigned to standard motor horsepower ratings in design guide tables such as NFPA-70 Tables 430-248, 430-249, 430-250; UL1077 Table 16.2; CSA - C22.2 No. 235-M89 Tables 44 and 45; CSA-C22.2 No. 14-M91 Table 19, etc. Multiply HEA values (in parenthesis) by 1.1 if power factor is 90%, and by 1.2 if power factor is 80%.

^a The standard-circuit short-circuit rating is 14kA for all types. Group ratings can be used in a standard circuit (e.g., MA1.0U at 42kA), but a higher standard rating cannot be used in a group circuit (e.g., MA40U at 14kA only in standard circuit.)

Dimensions in mm

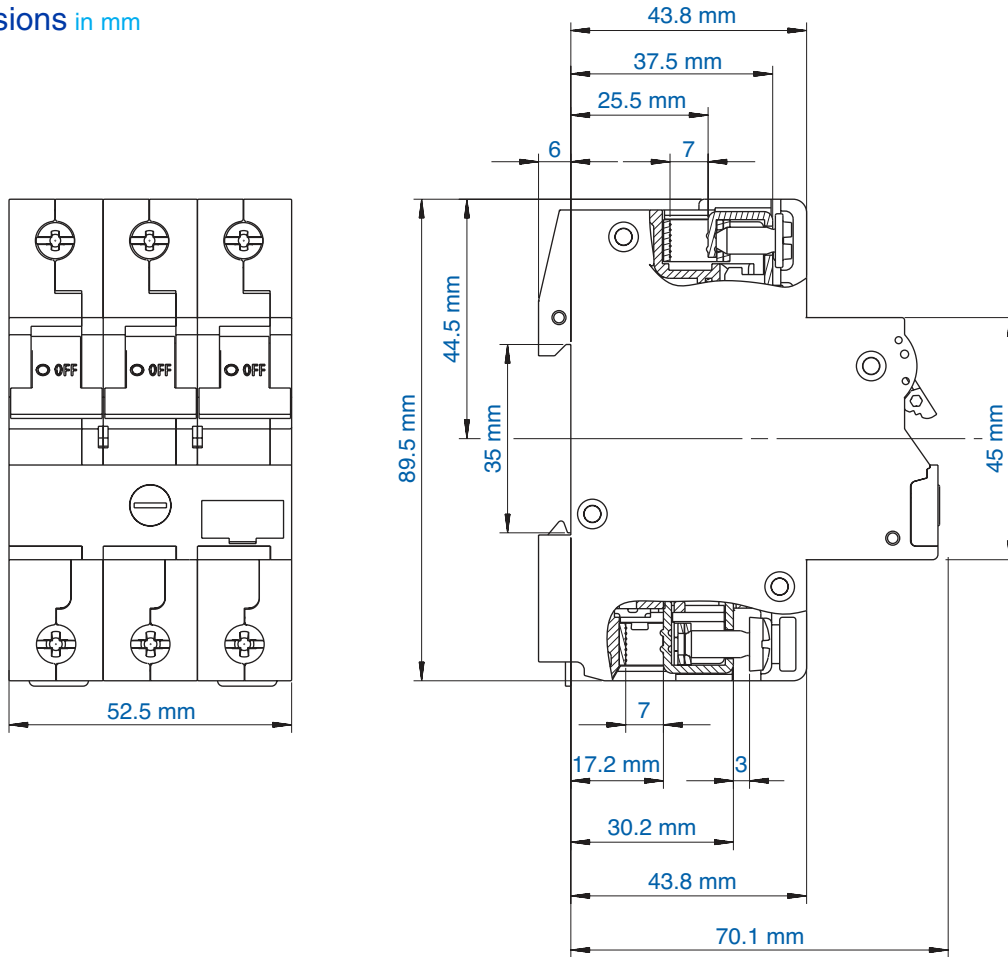

MA- Series Trip Curves

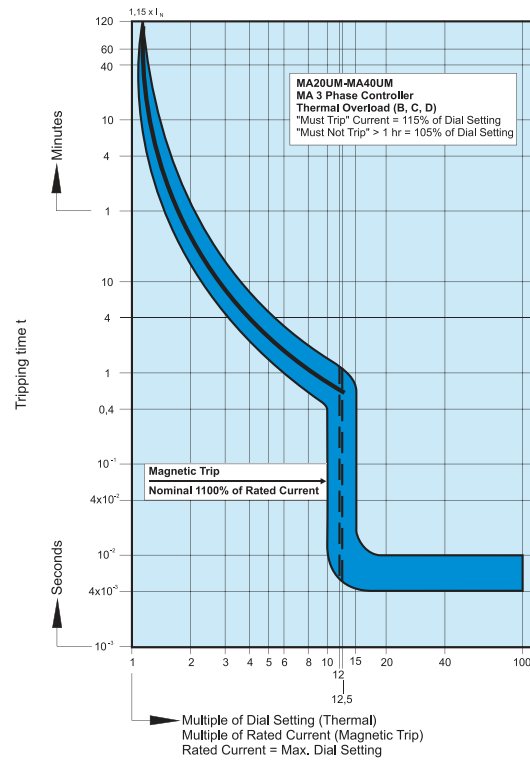
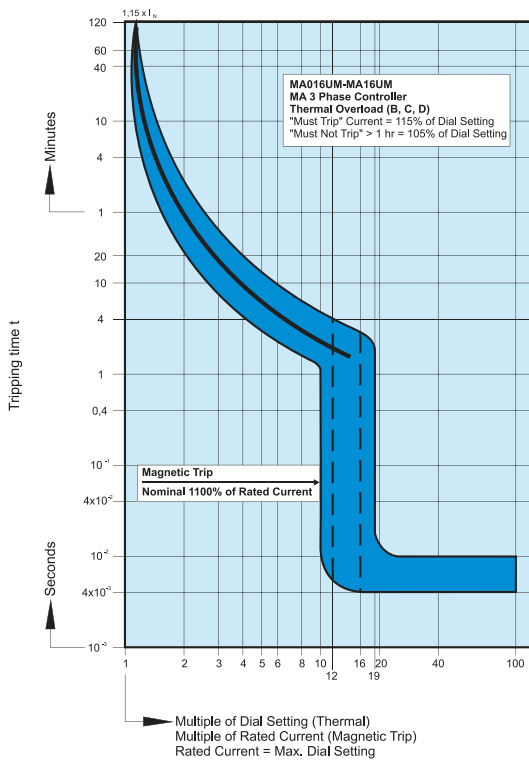

MA/USA Manual Motor Controller

UL 489

UL 508

UL 1077

UL 1077
Equipment Breakers

Earth Leakage
Circuit Breakers

ANNEX

UM (V-EA) and MA Accessories

For mounting instructions please refer to page 61.



Auxiliary Contact, Alarm Switch



Type/ Cat No.	Description	Contacts Type	Std Pk
H10UM	1 Auxiliary Contact	1NO	6
H11UM	2 Auxiliary Contacts	1NO + 1NC	6
H12UM	3 Auxiliary Contacts	1NO + 2NC	6
H21UM	3 Auxiliary Contacts	2NO + 1NC	6
HLS11M*	1 Auxiliary/1 Signal Contacts	1CO + 1CO (Signal)	6

Rated Operating Currents	10A@240V AC 3A@110V DC 1A@220V DC
Minimum Contact Load	1mA @ 24V DC
Torque	max. 0.8Nm (7 lb.in)

Wire Range:	
Single Wire	1.0mm ² - 2.5mm ² (18-14 AWG)
Stranded Wire	1.0mm ² - 1.5mm ² (18-16 AWG)
Stranded Wire with Ferrule	1.0mm ² - 1.5mm ² (18-16 AWG)

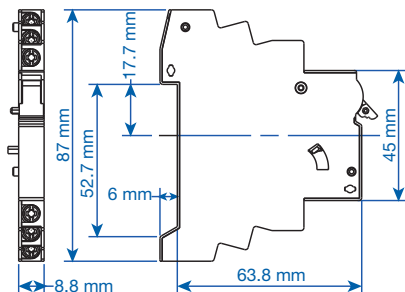

Dimensions HxxUM.



Shunt Trip

Type/ Cat No.	Rated Voltage U _N	Max. Operating Current @ U _N	Std Pk
FA12UM	12V AC/DC	1.3A	5
FA24UM	24V AC/DC	0.6A	5
FA48UM	48 - 72V AC/DC	0.2A	5
FA110UM	110 - 240V AC/DC, 277V AC	0.25A @ 110V 0.5A @ 240V 0.58A @ 277V	5

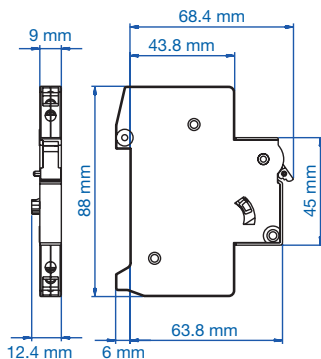

Dimensions HLS11M.

UM (V-EA) and MA Accessories

For mounting instructions please refer to page 61.



Neutral Pole

Type/ Cat No.	Rated Current I_N	Rated Voltage U_N	Std Pk
N63UM	0.3 - 63A	480Y/277V AC	6

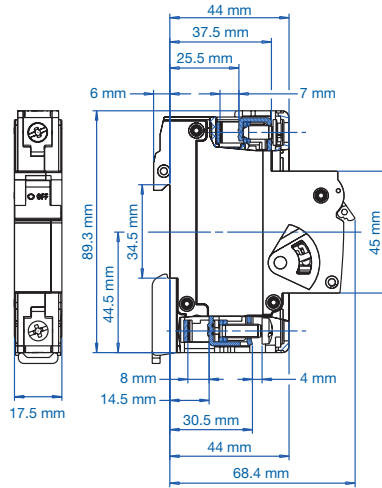

Dimensions N63UM, FxaxUM.



Touch Protection Caps

to cover the terminal screw holes on the switching devices, neutral Poles and shunt trips for increased touch protection.

Type/ Cat No.	Std Pk
BS.UL	100

Cooling Spacer



Type/ Cat No.	Std Pk
15.960	1



Mounting Screw 34mm

to connect the auxiliary contact and shunt trip or neutral Pole to the circuit breaker.

Type/ Cat No.	Std Pk
E983419	10



Lock-out Adapter**

Type/ Cat No.	Std Pk
EASS	10

** UM (V-EA) and MA can also be locked in the on and off position by simply using a common lead or meter seal, which gets fed through the hole in the handle and a corresponding hole in the housing.

UR Series

UL1077 Recognized Supplementary Protector

- DIN Rail Mounted
- 17.5mm width per pole
- Thermal Magnetic
- 0.5-60A / 480Y/277V AC, 50/60Hz
- 10kA Short Circuit Withstand Capacity
- Applications (on the load side of Branch Circuit Protection) include: Sensitive Electronics, Power Supplies, Appliance circuits, etc.



UR - Series	
Voltage Rating	0.5-60A / 480Y/277V AC
Short Circuit Withstand Rating	0.5 - 10A (RC): 10 kA with no back-up fuse 8 - 63A (RC): 10 kA with UL-listed Class J back-up fuse; 5 kA with no back-up fuse
Calibration Temperature	30°C (86°F)
Ambient Temperature	-25°C to +70°C (-13°F to 158°F)
Storage Temperature	-40°C to +70°C (-40°F to 158°F)
Terminal Torque (min/max)	2 Nm (17.7 lb.in.) / 2.5Nm (22.2 lb.in)
Electrical Life	6,000 switching cycles ON/ OFF
Mechanical Life	10,000 switching cycles ON/ OFF
Vibration Resistance	> 15g according to DIN EN 60069-2-59 during a load with 1.05 x I _N
Resistance to mechanical shocks	25g @ 11ms
Degree of protection acc. IEC/EN 60529	IP20
Mounting Orientation	In any plane

Short Circuit Withstand Ratings for R-Series Supplementary Protector

Trip Curve	Amp Range	Backup Protection	
		UL-Listed Class J Fuse up to 10kA	No Backup Fuse Required up to:
All	0.5 - 10A	70A	10kA
All	12 - 60A	4xRC*	5kA

*up to nearest rated current

Marking Details

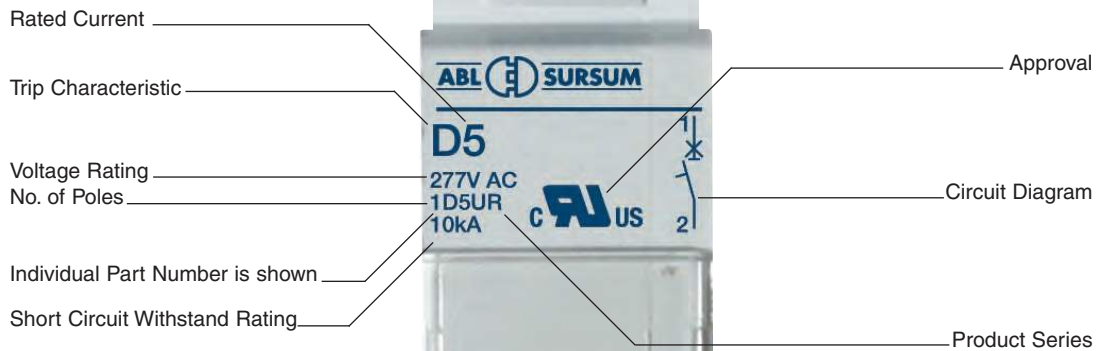

Dimensions in mm

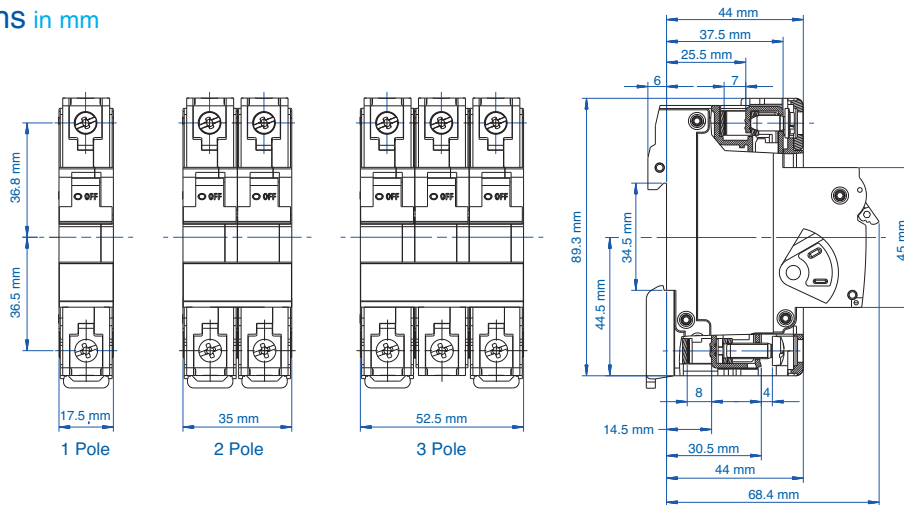

Application Overview

Trip-Characteristics*				Applications					
Characteristic Trip Boundaries				Lighting Wiring Protection Control Circuits	Business Equipment Appliances	Control Transformers	Power Supplies	General Electronics	Reactive Load
Thermal Trip		Magnetic Trip							
Must not Trip > 100ms	Must Trip < 1hr	Must not Trip > 100ms	Must Trip at 100ms						
B-Characteristics									
1.13xRC	1.45xRC	3xRC	5xRC						
C-Characteristics									
1.13xRC	1.45xRC	5xRC	10xRC						
D-Characteristics									
1.13xRC	1.45xRC	10xRC	20xRC						

*The value of each characteristic is shown vertically beneath its corresponding heading.



Warning!

This information should only be used as a selection guide. The use of a Miniature Circuit Breaker/Supplementary Protector in an application with a certain Trip-Characteristic always requires prototype testing! It is the responsibility of the circuit design engineer to select the appropriate Miniature Circuit Breaker/Supplementary Protector for his specific application.

UL 489

UL 508

UL 1077

UL 1077
Equipment Breakers

Earth Leakage
Circuit Breakers

ANNEX

UR - Series B-Trip Characteristic

Application Examples:

Business equipment, wiring protection, lighting, appliances, control circuits, some motors and some electronic applications. Relatively long thermal trip delay but low magnetic trip point.



One Pole

Rated Current	Type/ Cat. No.	Rated Voltage
0.5A	1B05UR	277V AC
1.0A	1B1UR	277V AC
2.0A	1B2UR	277V AC
3.0A	1B3UR	277V AC
4.0A	1B4UR	277V AC
5.0A	1B5UR	277V AC
6.0A	1B6UR	277V AC
8.0A	1B8UR	277V AC
10A	1B10UR	277V AC
12A	1B12UR	277V AC
13A	1B13UR	277V AC
15A	1B15UR	277V AC
16A	1B16UR	277V AC
20A	1B20UR	277V AC
25A	1B25UR	277V AC
30A	1B30UR	277V AC
32A	1B32UR	277V AC
40A	1B40UR	277V AC
50A	1B50UR	277V AC
60A	1B60UR	277V AC
63A*	1B63UR	277V AC

Standard Pack: 12

Weight:

0.3A - 32A

1.75kg (3.86 lb.)

40A - 63A

2.07kg (4.56 lb.)



Three Pole

Rated Current	Type/ Cat. No.	Rated Voltage
0.5A	3B05UR	480Y/277V AC
1.0A	3B1UR	480Y/277V AC
2.0A	3B2UR	480Y/277V AC
3.0A	3B3UR	480Y/277V AC
4.0A	3B4UR	480Y/277V AC
5.0A	3B5UR	480Y/277V AC
6.0A	3B6UR	480Y/277V AC
8.0A	3B8UR	480Y/277V AC
10A	3B10UR	480Y/277V AC
12A	3B12UR	480Y/277V AC
13A	3B13UR	480Y/277V AC
15A	3B15UR	480Y/277V AC
16A	3B16UR	480Y/277V AC
20A	3B20UR	480Y/277V AC
25A	3B25UR	480Y/277V AC
30A	3B30UR	480Y/277V AC
32A	3B32UR	480Y/277V AC
40A	3B40UR	480Y/277V AC
50A	3B50UR	480Y/277V AC
60A	3B60UR	480Y/277V AC
63A*	3B63UR	480Y/277V AC

Standard Pack: 4

Weight:

0.3A - 32A

1.75kg (3.86 lb.)

40A - 63A

2.07kg (4.56 lb.)



Two Pole

Rated Current	Type/ Cat. No.	Rated Voltage
0.5A	2B05UR	480Y/277V AC
1.0A	2B1UR	480Y/277V AC
2.0A	2B2UR	480Y/277V AC
3.0A	2B3UR	480Y/277V AC
4.0A	2B4UR	480Y/277V AC
5.0A	2B5UR	480Y/277V AC
6.0A	2B6UR	480Y/277V AC
8.0A	2B8UR	480Y/277V AC
10A	2B10UR	480Y/277V AC
12A	2B12UR	480Y/277V AC
13A	2B13UR	480Y/277V AC
15A	2B15UR	480Y/277V AC
16A	2B16UR	480Y/277V AC
20A	2B20UR	480Y/277V AC
25A	2B25UR	480Y/277V AC
30A	2B30UR	480Y/277V AC
32A	2B32UR	480Y/277V AC
40A	2B40UR	480Y/277V AC
50A	2B50UR	480Y/277V AC
60A	2B60UR	480Y/277V AC
63A*	2B63UR	480Y/277V AC

Standard Pack: 6

Weight:

0.3A - 32A

1.75kg (3.86 lb.)

40A - 63A

2.07kg (4.56 lb.)



Add-on Neutral Pole

Rated Current	Type/ Cat. No.	Rated Voltage
0.3-63A	N63UM	480/277V AC

Standard Pack: 6

Weight:

0.775kg (1.71)

*63A is not UL Recognized.

UR - Series C-Trip Characteristic

Application Examples:

Low inrush motors, lighting, wiring protection, appliances, business equipment, and control circuit applications. Relatively long thermal trip delay and medium magnetic trip point.



One Pole



Standard Pack: 12

Weight:
0.3A - 32A
1.75kg (3.86 lb.)
40A - 63A
2.07kg (4.56 lb.)

Rated Current	Type/ Cat. No.	Rated Voltage
0.5A	1C05UR	277V AC
1.0A	1C1UR	277V AC
2.0A	1C2UR	277V AC
3.0A	1C3UR	277V AC
4.0A	1C4UR	277V AC
5.0A	1C5UR	277V AC
6.0A	1C6UR	277V AC
8.0A	1C8UR	277V AC
10A	1C10UR	277V AC
12A	1C12UR	277V AC
13A	1C13UR	277V AC
15A	1C15UR	277V AC
16A	1C16UR	277V AC
20A	1C20UR	277V AC
25A	1C25UR	277V AC
30A	1C30UR	277V AC
32A	1C32UR	277V AC
40A	1C40UR	277V AC
50A	1C50UR	277V AC
60A	1C60UR	277V AC
63A*	1C63UR	277V AC

Three Pole



Standard Pack: 4

Weight:
0.3A - 32A
1.75kg (3.86 lb.)
40A - 63A
2.07kg (4.56 lb.)

Rated Current	Type/ Cat. No.	Rated Voltage
0.5A	3C05UR	480Y/277V AC
1.0A	3C1UR	480Y/277V AC
2.0A	3C2UR	480Y/277V AC
3.0A	3C3UR	480Y/277V AC
4.0A	3C4UR	480Y/277V AC
5.0A	3C5UR	480Y/277V AC
6.0A	3C6UR	480Y/277V AC
8.0A	3C8UR	480Y/277V AC
10A	3C10UR	480Y/277V AC
12A	3C12UR	480Y/277V AC
13A	3C13UR	480Y/277V AC
15A	3C15UR	480Y/277V AC
16A	3C16UR	480Y/277V AC
20A	3C20UR	480Y/277V AC
25A	3C25UR	480Y/277V AC
30A	3C30UR	480Y/277V AC
32A	3C32UR	480Y/277V AC
40A	3C40UR	480Y/277V AC
50A	3C50UR	480Y/277V AC
60A	3C60UR	480Y/277V AC
63A*	3C63UR	480Y/277V AC

Two Pole



Standard Pack: 6

Weight:
0.3A - 32A
1.75kg (3.86 lb.)
40A - 63A
2.07kg (4.56 lb.)

Rated Current	Type/ Cat. No.	Rated Voltage
0.5A	2C05UR	480Y/277V AC
1.0A	2C1UR	480Y/277V AC
2.0A	2C2UR	480Y/277V AC
3.0A	2C3UR	480Y/277V AC
4.0A	2C4UR	480Y/277V AC
5.0A	2C5UR	480Y/277V AC
6.0A	2C6UR	480Y/277V AC
8.0A	2C8UR	480Y/277V AC
10A	2C10UR	480Y/277V AC
12A	2C12UR	480Y/277V AC
13A	2C13UR	480Y/277V AC
15A	2C15UR	480Y/277V AC
16A	2C16UR	480Y/277V AC
20A	2C20UR	480Y/277V AC
25A	2C25UR	480Y/277V AC
30A	2C30UR	480Y/277V AC
32A	2C32UR	480Y/277V AC
40A	2C40UR	480Y/277V AC
50A	2C50UR	480Y/277V AC
60A	2C60UR	480Y/277V AC
63A*	2C63UR	480Y/277V AC

Add-on Neutral Pole



Rated Current	Type/ Cat. No.	Rated Voltage
0.3-63A	N63UM	480/277V AC

Standard Pack: 6

Weight:
0.775kg (1.71)

*63A is not UL Recognized.

UL 489

UL 508

UL 1077

UL 1077
Equipment Breakers

Earth Leakage
Circuit Breakers

ANNEX

UR - Series D-Trip Characteristic

Application Examples:

Control transformers, power supplies, reactive loads. Relatively long thermal trip delay and very high magnetic trip point.



UL Recognized
E137915



Standard Pack: 12

Weight:

0.3A - 32A

1.75kg (3.86 lb.)

40A - 63A

2.07kg (4.56 lb.)

One Pole

Rated Current	Type/ Cat. No.	Rated Voltage
0.5A	1D05UR	277V AC
1.0A	1D1UR	277V AC
2.0A	1D2UR	277V AC
3.0A	1D3UR	277V AC
4.0A	1D4UR	277V AC
5.0A	1D5UR	277V AC
6.0A	1D6UR	277V AC
8.0A	1D8UR	277V AC
10A	1D10UR	277V AC
12A	1D12UR	277V AC
13A	1D13UR	277V AC
15A	1D15UR	277V AC
16A	1D16UR	277V AC
20A	1D20UR	277V AC
25A	1D25UR	277V AC
30A	1D30UR	277V AC
32A	1D32UR	277V AC
40A	1D40UR	277V AC
50A	1D50UR	277V AC
60A	1D60UR	277V AC
63A*	1D63UR	277V AC



Standard Pack: 4

Weight:

0.3A - 32A

1.75kg (3.86 lb.)

40A - 63A

2.07kg (4.56 lb.)

Three Pole

Rated Current	Type/ Cat. No.	Rated Voltage
0.5A	3D05UR	480Y/277V AC
1.0A	3D1UR	480Y/277V AC
2.0A	3D2UR	480Y/277V AC
3.0A	3D3UR	480Y/277V AC
4.0A	3D4UR	480Y/277V AC
5.0A	3D5UR	480Y/277V AC
6.0A	3D6UR	480Y/277V AC
8.0A	3D8UR	480Y/277V AC
10A	3D10UR	480Y/277V AC
12A	3D12UR	480Y/277V AC
13A	3D13UR	480Y/277V AC
15A	3D15UR	480Y/277V AC
16A	3D16UR	480Y/277V AC
20A	3D20UR	480Y/277V AC
25A	3D25UR	480Y/277V AC
30A	3D30UR	480Y/277V AC
32A	3D32UR	480Y/277V AC
40A	3D40UR	480Y/277V AC
50A	3D50UR	480Y/277V AC
60A	3D60UR	480Y/277V AC
63A*	3D63UR	480Y/277V AC



Standard Pack: 6

Weight:

0.3A - 32A

1.75kg (3.86 lb.)

40A - 63A

2.07kg (4.56 lb.)

Two Pole

Rated Current	Type/ Cat. No.	Rated Voltage
0.5A	2D05UR	480Y/277V AC
1.0A	2D1UR	480Y/277V AC
2.0A	2D2UR	480Y/277V AC
3.0A	2D3UR	480Y/277V AC
4.0A	2D4UR	480Y/277V AC
5.0A	2D5UR	480Y/277V AC
6.0A	2D6UR	480Y/277V AC
8.0A	2D8UR	480Y/277V AC
10A	2D10UR	480Y/277V AC
12A	2D12UR	480Y/277V AC
13A	2D13UR	480Y/277V AC
15A	2D15UR	480Y/277V AC
16A	2D16UR	480Y/277V AC
20A	2D20UR	480Y/277V AC
25A	2D25UR	480Y/277V AC
30A	2D30UR	480Y/277V AC
32A	2D32UR	480Y/277V AC
40A	2D40UR	480Y/277V AC
50A	2D50UR	480Y/277V AC
60A	2D60UR	480Y/277V AC
63A*	2D63UR	480Y/277V AC



Add-on Neutral Pole

Rated Current	Type/ Cat. No.	Rated Voltage
0.3-63A	N63UM	480/277V AC

Standard Pack: 6

Weight:

0.775kg (1.71)

*63A is not UL Recognized.

UR Series Accessories

For mounting instructions please refer to page 43.



Auxiliary Contact, Alarm Switch



Type/ Cat No.	Description	Contacts Type	Std Pk
H10UM	1 Auxiliary Contact	1NO	6
H11UM	2 Auxiliary Contacts	1NO + 1NC	6
H12UM	3 Auxiliary Contacts	1NO + 2NC	6
H21UM	3 Auxiliary Contacts	2NO + 1NC	6
HLS11M*	1 Auxiliary/ 1 Signal Contacts	1CO + 1CO (Signal)	6

Rated Operating Currents
10A @ 240V AC
3A @ 110V DC
1A @ 220V DC

Minimum Contact Load 1mA @ 24V DC
Torque max. 0.8Nm (7 lb.in)

Wire Range:
Single Wire 1.0mm² - 2.5mm² (18-14 AWG)
Stranded Wire 1.0mm² - 1.5mm² (18-16 AWG)
Stranded Wire with Ferrule 1.0mm² - 1.5mm² (18-16 AWG)

Shunt Trip



Type/ Cat No.	Rated Voltage U _N	Max. Operating Current @ U _N	Std Pk
FA12UM	12V AC/DC	1.3A	5
FA24UM	24V AC/DC	0.6A	5
FA48UM	48 - 72V AC/DC	0.2A	5
FA110UM	110 - 240 V AC/DC, 277V AC	0.25A @ 110V 0.5A @ 240V 0.58A @ 277V	5

Undervoltage Trip*



Type/ Cat No.	Line Voltage V _E	Std Pk
UA120UM	120V AC, 60Hz	5

Reset-Hold Voltage = 0.85 x V_E
Drop-Out Voltage = 0.35 ~ 0.7 x V_E
V_E = Rated Voltage

Neutral Pole

Type/ Cat No.	Rated Current I _N	Rated Voltage U _N	Std Pk
N63UM	0.3 - 63A	480Y/277V AC	6

Touch Protection Caps

to cover the terminal screw holes on the switching devices, neutral Poles and shunt trips for increased touch protection.



Type/ Cat No.	Std Pk	Type/ Cat No.	Std Pk
BS.UL	100	15.960	1

Mounting Screw 34mm

to connect the auxiliary contact and shunt trip or neutral Pole to the circuit breaker.



Type/ Cat No.	Std Pk	Type/ Cat No.	Std Pk
E983419	10	EASS	10

Cooling Spacer



Lock-out Adapter**

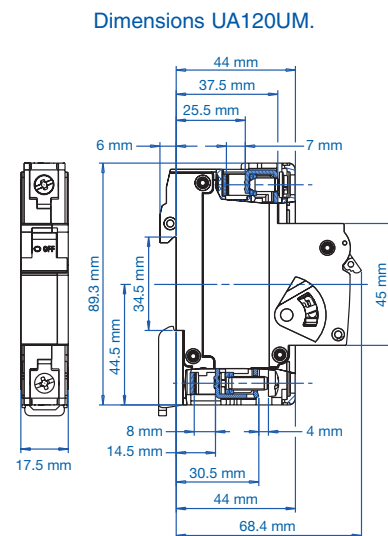
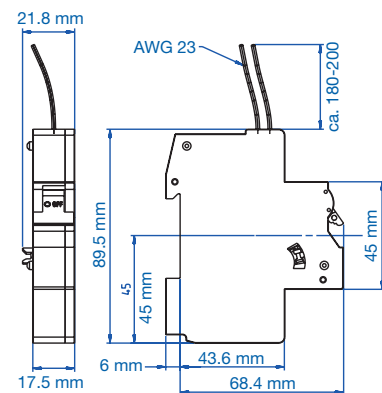
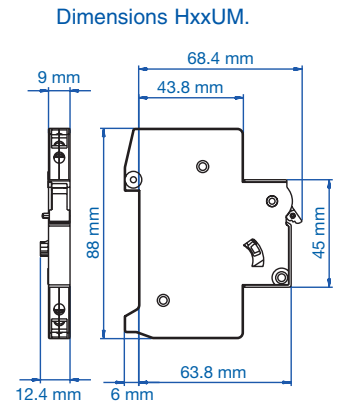
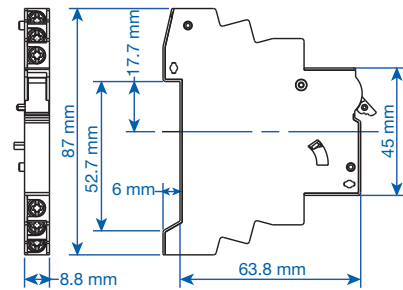

UL 489

UL 508

UL 1077

UL 1077
Equipment Breakers

Earth Leakage
Circuit Breakers

ANNEX

* Not UL approved.

** UR series can also be locked in the on and off position by simply using a common lead or meter seal, which gets fed through the hole in the handle and a corresponding hole in the housing.

UR Series Trip Curves

B Trip Curve

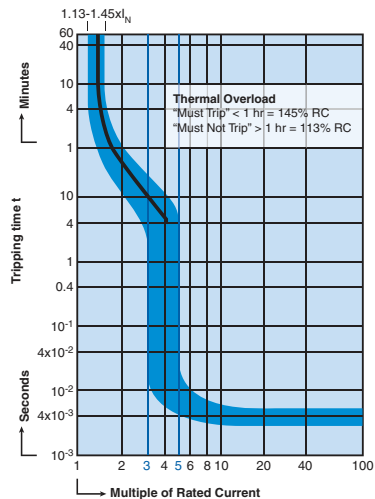

0.5A Through 10A Rated Current

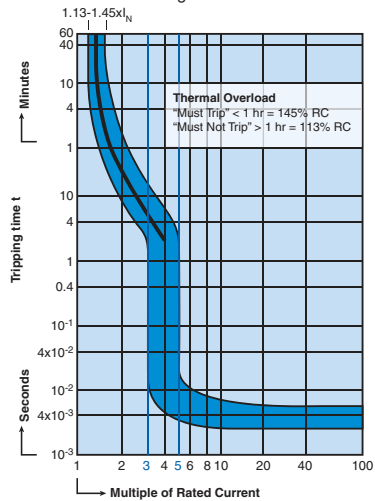

12A Through 63A Rated Current

“B” Magnetic Trip Parameters

Rated current 0.5A to 63A.

1. Hold for a minimum of 100ms at surge of 3 times rated current.
2. Trip in under 100ms at 5 times rated current.

C Trip Curve

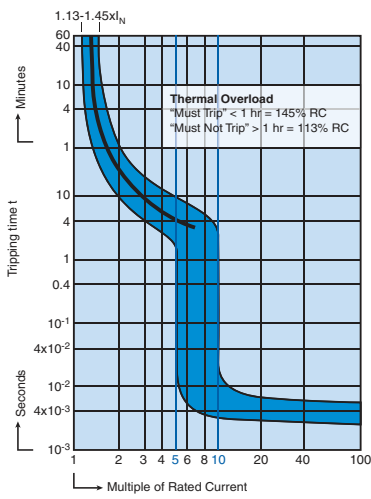

0.5A Through 10A Rated Current

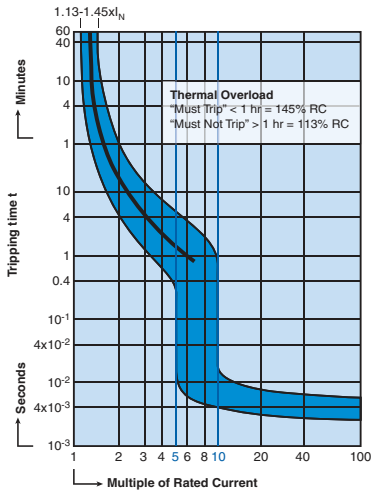

12A Through 63A Rated Current

“C” Magnetic Trip Parameters

Rated current 0.5A to 63A.

1. Hold for a minimum of 100ms at surge of 5 times rated current.
2. Trip in under 100ms at 10 times rated current.

D Trip Curve

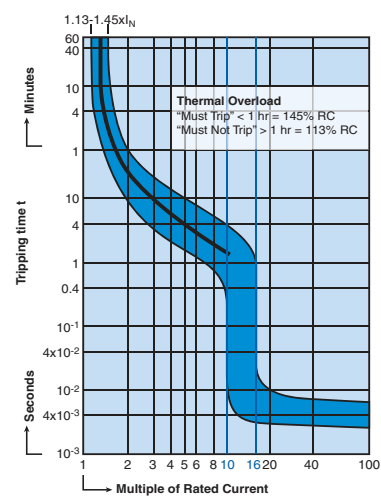

0.3A Through 10A Rated Current

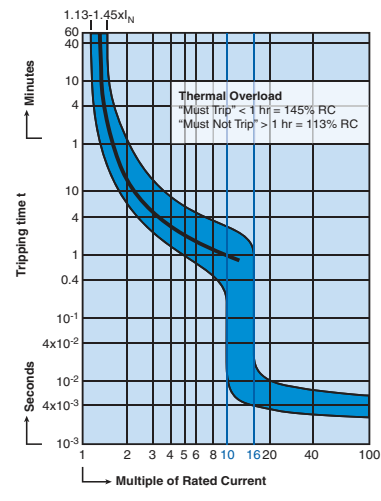

12A Through 63A Rated Current

“D” Magnetic Trip Parameters

Rated current 0.5A to 63A.

1. Hold for a minimum of 100ms at surge of 10 times rated current.
2. Trip in under 100ms at 16 times rated current.

UR Series Internal Resistance

Rated Current (A)	B (Ohm)	C (Ohm)	D (Ohm)
0.5	8.0400	6.8540	6.0009
1.0	1.7000	1.7000	1.7560
2.0	0.4190	0.4190	0.4190
3.0	0.2020	0.2020	0.2020
4.0	0.1090	0.1090	0.1090
5.0	0.0654	0.0654	0.0654
6.0	0.0528	0.0528	0.0491
8.0	0.0278	0.0278	0.0240
10	0.0216	0.0216	0.0187
12/ 13	0.0113	0.0084	0.0085
15/ 16	0.0085	0.0085	0.0076
20	0.0067	0.0067	0.0064
25	0.0050	0.0050	0.0041
30/ 32	0.0032	0.0032	0.0027
40	0.0025	0.0025	0.0022
50	0.0019	0.0019	0.0018
60/ 63*	0.0018	0.0018	0.0017

UL 489

UL 508

UL 1077

UL 1077

Equipment Breakers

Earth Leakage Circuit Breakers

ANNEX

Temperature Correction Curve (UL, DL, V-EA, MA and UR series)

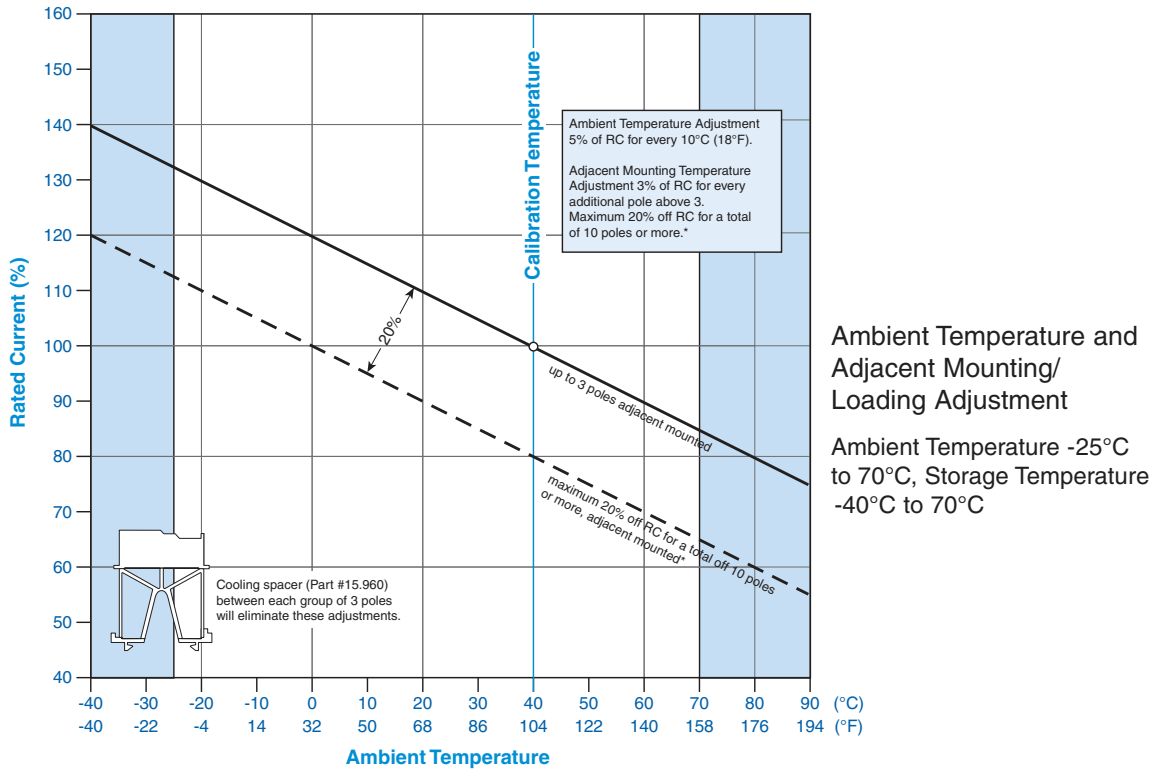

Accessory Mounting Instructions (UL, V-EA and UR series)

Neutral / Shunt Trip + Auxiliary Contact

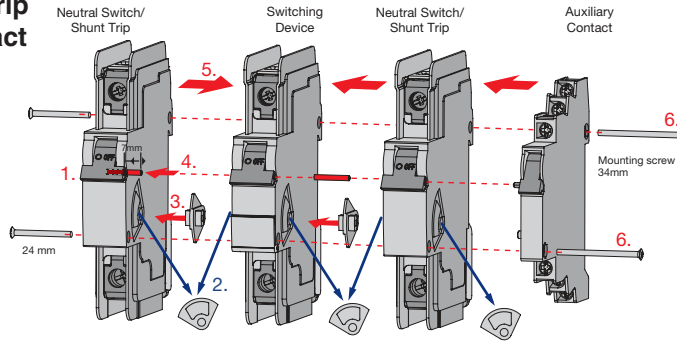

Neutral Poles N63UM, N32UL, N63UL or Shunt Trips FA..UM, FA..UL can be mounted on the right or left side of the circuit protection device.

1. Turn handle to off position.
2. Remove gray cover from the circuit protection device and accessory.
3. Insert linkage component between circuit protection device and neutral pole (N63UM, N32UL, N63UL) or shunt trip (FA..UM, FA..UL).
4. Insert connecting pin into handle.
5. Assemble circuit protection device and neutral pole (N63UM, N32UL, N63UL) or shunt trip (FA..UM, FL..UL).
6. The auxiliary contact (H..UM, H..UL) can also be mounted on the right side by using a different screw (E983419; see accessory pages 14, 32 or 41).

After final assembly check operation by moving the handle to the ON/OFF position several times.

Auxiliary Contact

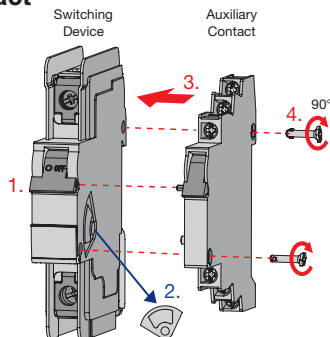

Auxiliary contact can be mounted on the right side of the circuit protection device only.

1. Turn handles to OFF position.
2. Remove gray cover from switching device.
3. Combine circuit protection device and auxiliary contact (H..UM, H..UL).
4. Insert mounting screws and connect the two devices by turning the screws 90° clockwise.

After final assembly check operation by moving the handle to the ON/OFF position several times.

UL 489

UL 508

UL 1077

UL 1077
Equipment Breakers

Earth Leakage
Circuit Breakers

ANNEX

DFS Series RCCB Earth Leakage Circuit Breakers

RCCB Series compact Earth Leakage Circuit Breakers detect and interrupt earth (ground) faults. They are VDE approved for the European system of protecting people, animals, equipment and property from dangerous line-to-ground and shock hazard currents.

US applications include ground-fault protection of equipment (GFPE) using the 10mA and 30mA fault current ratings, especially when high distributed capacitance or other leakages cause excessive nuisance trips at lower fault currents. Applications for the 300mA and 500mA ratings are equipment protection and fire prevention, limiting the energy of a fault to less than the minimum ignition energy for many materials.

Type Designation

DFS (a) (b) (c)

(a): 11 = 16A, 12 = 25A, 13 = 40A,
14 = 63A, 15 = 80A, 16 = 100A,
17 = 125A

(b): 2 = 10mA, 4 = 30mA,
6 = 300mA, 7 = 500mA

(c): 601 = 2 pole, 911 = 4 pole



DFS2



DFS4



Maximum Rated Line Current	Fault Trip Current	Cat. No.	Supersedes	Fault Trip Current	Cat. No.	Supersedes
16A	10mA	09112601	RP2101			
25A	30mA	09124601	RP2203	30mA	09124911	RP4203
25A	300mA	09126601	RP2230	300mA	09126911	RP4230
25A				500mA	09127911	RP4250
40A	30mA	09134601	RP2303	30mA	09134911	RP4303
40A	300mA	09136601	RP2330	300mA	09136911	RP4330
40A				500mA	09137911	RP4350
63A	30mA	09144601	RP2403	30mA	09144911	RP4403
63A	300mA	09146601	RP2430	300mA	09146911	RP4430
63A	500mA			500mA	09147911	RP4450
80A				30mA	09154911	RP4503
80A				300mA	09156911	RP4530
80A				500mA	09157911	RP4550
100A				30mA	09164911	RP4603
100A				300mA	09166911	RP4630
100A				500mA	09167911	RP4650
125A				30mA	09174911	RP4703
125A				300mA	09176911	RP4730
125A				500mA	09177911	RP4750

Stock items are shown in BOLD.

Voltage Rating (maximum)	230V AC, 50Hz	400Y/230V AC, 50Hz
Min Operating Voltage Bank of Test Circuit	150V	200V
Short Circuit Withstand Rating	No back-up fuse: Rated current (RC) 16/25/40A: 500A; RC 63/80A: 800A; RC 100A: 1000A; RC 125A-1250A. With back-up fuse: 10kA; Size of fuse: (2 pole version): RC 25/40/63: 100A; (4 pole version): RC 25/40/63A: 100A; RC 80/100/125A: 125A	
Fault Trip Current Calibration	DFS trips are calibrated at less than fault trip current for ensured safety (Typical trip range between 66.6-83.3% fault trip current, e.g., typical trip at 20-25mA for fault RC of 30mA)	
Typical Life	Fully functional after 5,000 operations to DIN/VDE 0664T10, IEC 61008-1 and 2000 additional fault current trips.	
Standard Pack and Weight	1/230g (0.6 lb.)	1/420-460g (0.9 lb.-1.0 lb.)
Terminal Size Acceptability	1.5-50mm ² (16-1 AWG)	1.5-50mm ² (16-1 AWG)
Terminal Torque	3Nm (26.5 lb.in.)	3Nm (26.5 lb.in.)

Circuit Diagram

a For 2-Phase applications, terminal 5 and 6 (next to Neutral terminals) must be connected to one phase for the test circuit to be operable.

b For voltage systems without a neutral conductor. Please use jumper from "1" or "3" to top "N" terminal. This will assure proper functioning of the "test" circuit.

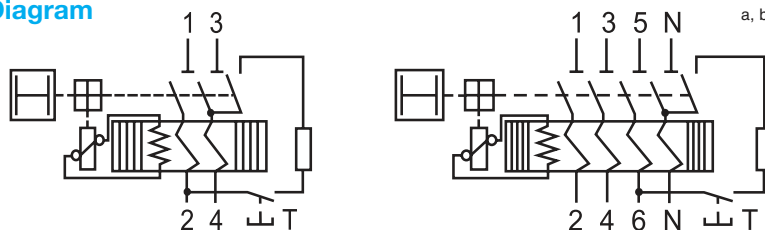

DHI11 - Auxiliary Switches / Error Signal Switch

Contact Rating	Wire Size	Torque	Cat. No.	Supersedes	Circuit Diagram
6A / 230V AC 1A / 110V DC	1-1.5mm ² (16 AWG)	max. 0.8Nm (7lb.in.)	DHI11	RH11	
Std. Pk.: 1 Unit Weight: 45 grams (0.12 lb.) Width: 9mm (.354in.)					

Note: If the power system has a marked conductor, it must connect through the DFS and not be grounded at any point downstream.



Dimensions in mm

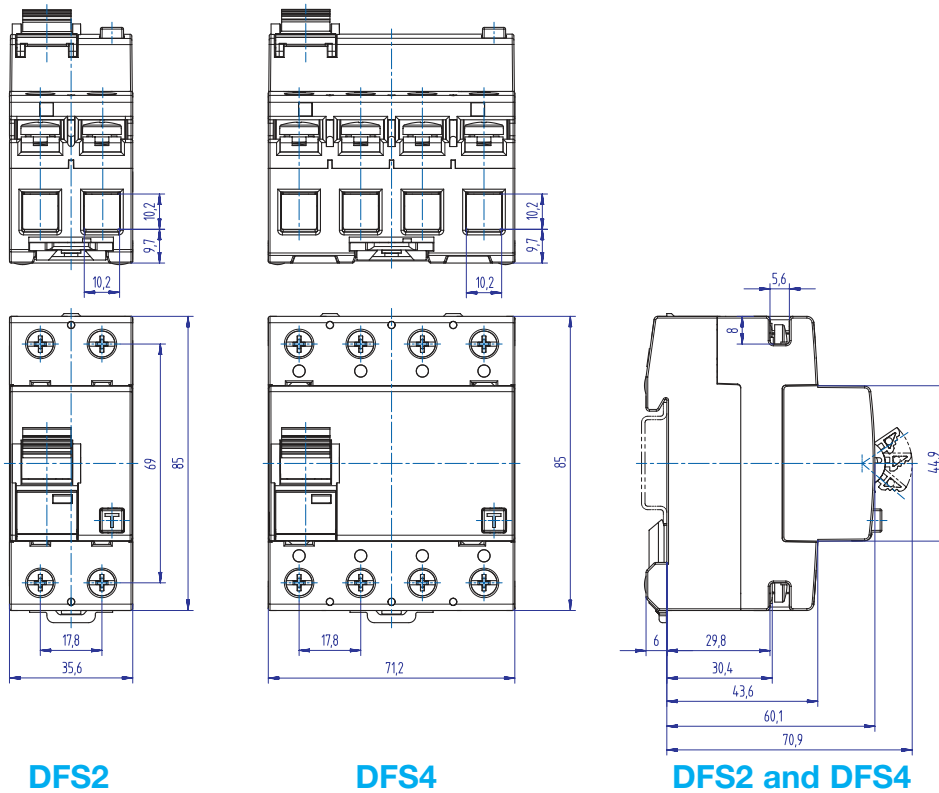

DFS2

DFS4

DFS2 and DFS4

Temperature Range	Environmental Information marked with "Snowflake" approval for -25°C to 40°C (-13°F to 104°F) ambient temperature. (Temperature effect on RC: for every 10°C temperature rise above 40°C decrease RC by 7%.)
Fluctuating Climate Conditions	According to IEC 60068-2-30: heat (25°C~55°C), relative humidity (93%~95%)
Electrical Shock Protection	Uninsulated electrically live parts within 30mm of the operating handle are "finger safe" (terminal screw heads) and uninsulated live parts within 100mm of the operating handle are "back-of-hand safe" (terminals).
Impact/Shock Protection	20g with impact force half-cycle sinusoidal and 20ms duration, 18 impacts total with 6 on each principal axis (3 impacts each face). DFS is DIN Rail mounted during the test, and electrically loaded with 25% of Fault RC. Successful testing required no trip during the test, no damage and no loosened parts.
Vibration/Seismic Resistance	5g, at frequency of ≤80Hz, applied for 30 minutes along each of the three principal axes, plus 5 minutes of application at every established critical resonant frequency. DFS is DIN Rail mounted during the test, and loaded with 25% Fault RC. To pass, the DFS did not trip at 25% Fault RC, but did trip between each of the principal axis tests when the fault current was raised to 125% Fault RC, and there was no damage and no loosened parts. Suitable for machinery and mobile vehicle applications.
Protection Class	IP20; higher protection Class is dependent on housing.
Non-Sinusoidal Fault	The DFS is tested and approval stamped for tripping sensitivity to non-sinusoidal fault currents, which become zero or almost zero within one cycle of the line frequency. Waveforms and allowed trip-current ranges are as follows: <ul style="list-style-type: none"> 1. AC Sinusoidal Fault - 0.5-1.0 times Fault RC 2a. Pulsating DC Fault; Positive and Negative Half-Waves - 0.35-1.4 times Fault RC 2b. Phased Half-Wave, 90° - 0.25-1.4 times Fault RC Phased Half-Wave, 135° - 0.11-1.4 times Fault RC 3. Pulsating DC on 6mA DC (continuous) Base - Max. 1.4 times Fault RC + 6mA

Insulation Category	At VDE rated voltage, suitable for Class C environments with relatively high dust and moisture levels and little HVAC control, e.g., industrial, commercial, agricultural; on machine tools, hoists, warehouse equipment, etc.; in boiler rooms, unheated storage, covered shipping/receiving, open workshops, etc.
----------------------------	---

UL 489

UL 508

UL 1077

UL 1077
Equipment Breakers

Earth Leakage
Circuit Breakers

ANNEX

altechcorp.com

Altech Corp.®

Quality Endorsed Company

ISO 9001:2008 CERTIFICATE

Altech Search

Google

Home Stock Check Distributors Information News Contact Rep/Dist Login Altech Mexico

WEB TOOLS

Altech Videos

Product Crossings

Request for Quote

Sample Request

Catalog Request

eBook Catalog

PRODUCT MENU

ATEX Products

Circuit Protection / Control

Connectors

Enclosures

European Spare Parts

Digital Panel Meters

Foot Switches

Interface Modules

Panel Accessories

Power Supplies

Power Semi-Conductors

Programmable Controllers

Push Buttons & Pilot Lights

Relays

Sensors

Safety Switches & Enclosures

Solid State Relays

Terminal Blocks

Test & Measurement

Travel Lights

New Products and Promotions

AS SHORT AS **2** Week Turn Around

CUSTOM ASSEMBLY and Valued Added Services

Imprinting
Relay Modules
Light Assemblies
Interface Modules

Component Carrier Modules
Foot Switch Assemblies
DIN Rail Assemblies
Enclosure Milling

Click for your local ALTECH REPRESENTATIVE

Serving the Automation & Control Industry Since 1984

CIRCUIT PROTECTION



CONNECTORS



ENCLOSURES

FOOT SWITCHES



MODULES & RELAYS

Altech Corporation
35 Royal Road
Flemington, NJ 08822-6000
Phone (908) 806-9400
Fax (908) 806-9490
www.altechcorp.com

Altech Corp.® 345-042016-5M

Altech Corp.®

Serving the Automation & Control Industry since 1984

Certified System
ISO 9001
CMI-SAI Global

Current Limiting



UL 489 Miniature Molded Case Circuit Breakers



UL 508 Manual Motor Controllers



UL 489, UL 508 and UL 1077 Busbar Devices



UL 1077 Supplementary Protector



Circuit Protection Products