



Features

- Bidirectional TVS 5 V
- Low capacitance 15 pF
- ESD protection >15k V
- Fits 0402 footprint



This series is currently available but not recommended for new designs.

CDDFN2-T4.7C – Surface Mount TVS Diode

General Information

The CDDFN2-T4.7C device provides ESD and EFT protection for external ports of electronic devices such as cellular phones, handheld electronics and other portable electronic devices.

The device measures 1.05 mm x 0.65 mm and is available in a DFN-2 package intended to be mounted directly onto an FR4 printed circuit board. The device will fit an 0402 footprint.

The device will meet IEC 61000-4-2 (ESD) and IEC 61000-4-4 (EFT) protection requirements.

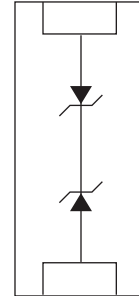

Electrical & Thermal Characteristics (@ T_A = 25 °C Unless Otherwise Noted)

Parameter	Symbol	Min.	Typ.	Max.	Unit
Peak Pulse Power @ 8/20 μs ¹	P _{PK}			75	W
Peak Pulse Current @ 8/20 μs	I _{pp}			5	A
Operating Temperature	T _{OPR}	-40	25	125	°C
Storage Temperature	T _{STG}	-55	25	150	°C

Parameter	Symbol	Min.	Typ.	Max.	Unit
Working Peak Voltage	V _{WM}		5.0		V
Breakdown Voltage @ 1 mA	V _{BR}	5.1	7.0		V
Leaking Current @ 5 V	I _L		0.1	2.0	μA
Capacitance @ 0 V, 1 MHz	C _J		15	20	pF
Clamping Voltage @ I _{pp} = 5 A 8/20 μs	V _C			15	V
ESD Protection per IEC 61000-4-2					
Contact Discharge	ESD	8			kV
Air Discharge	ESD	15			kV
EFT Protection per IEC 61000-4-4 @ 5/50 ns	EFT			40	A
Surge Protection per IEC 61000-4-5 @ 8/20 μs	Surge			5	A

Notes:

1. See Peak Pulse Power vs. Pulse Time.

CDDFN2-T4.7C – Surface Mount TVS Diode



Product Dimensions

This is a Molded DFN-2 package with lead free 100 % Sn plating on the terminations. It weighs approximately 30 mg.

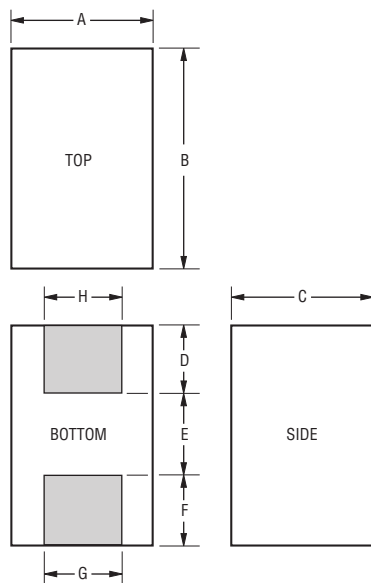

DIMENSIONS: $\frac{\text{MM}}{\text{(INCHES)}}$

Dimensions	
A	$\frac{0.55 - 0.65}{(0.022 - 0.026)}$
B	$\frac{0.95 - 1.05}{(0.037 - 0.041)}$
C	$\frac{0.45 - 0.55}{(0.018 - 0.022)}$
D	$\frac{0.30}{(0.012)}$
E	$\frac{0.432}{(0.017)}$
F	$\frac{0.30}{(0.012)}$
G	$\frac{0.50}{(0.020)}$
H	$\frac{0.50}{(0.020)}$

Recommended PCB Footprint

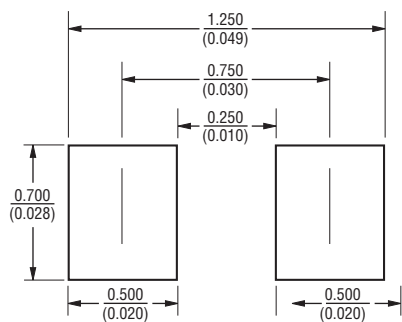

Block Diagram

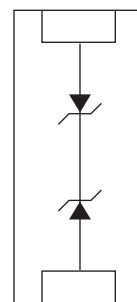

Typical Part Marking

CDDFN2-T4.7CE5

CDDFN2-T4.7C – Surface Mount TVS Diode



Performance Graphs

Peak Pulse Power vs Pulse Time

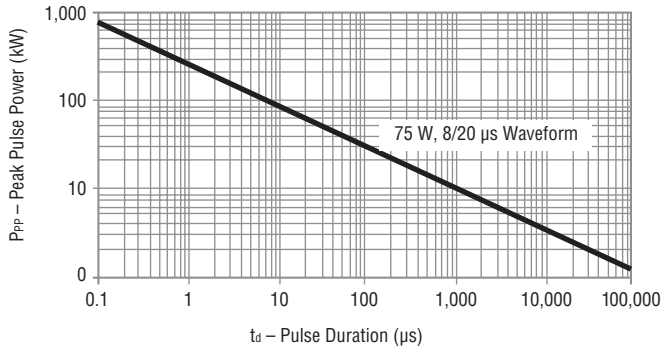

Pulse Wave Form

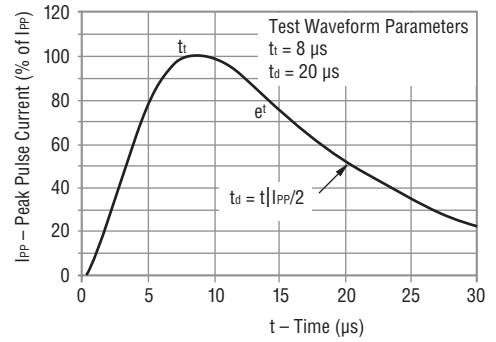

Overshoot & Clamping voltage

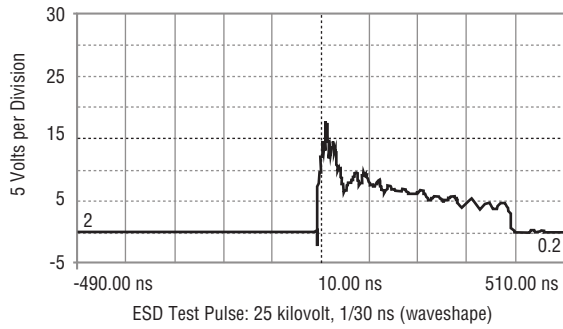

Reverse Characteristics

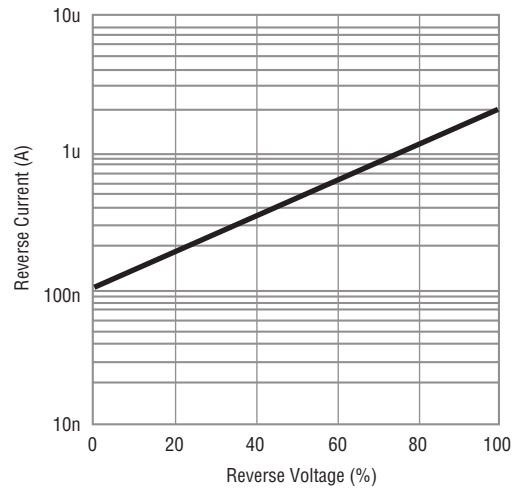

Power Derating Curve

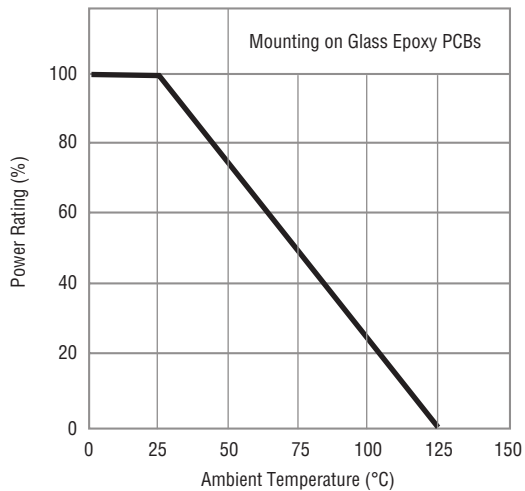

How To Order

CD DFN2 - T 4.7 C
 Common Code _____
 Chip Diode
 Package _____
 • DFN2 = DFN-2 Package
 Model _____
 T = Transient Voltage Suppressor
 Working Peak Reverse Voltage _____
 4.7 = 4.7 V_{RWM} (Volts)
 Suffix _____
 C = Bidirectional Diode

Specifications are subject to change without notice. Customers should verify actual device performance in their specific applications.

CDDFN2-T4.7C – Surface Mount TVS Diode

BOURNS®

Packaging Information

The surface mount product is packaged in an 8 mm x 4 mm tape and reel format per EIA-481 standard.

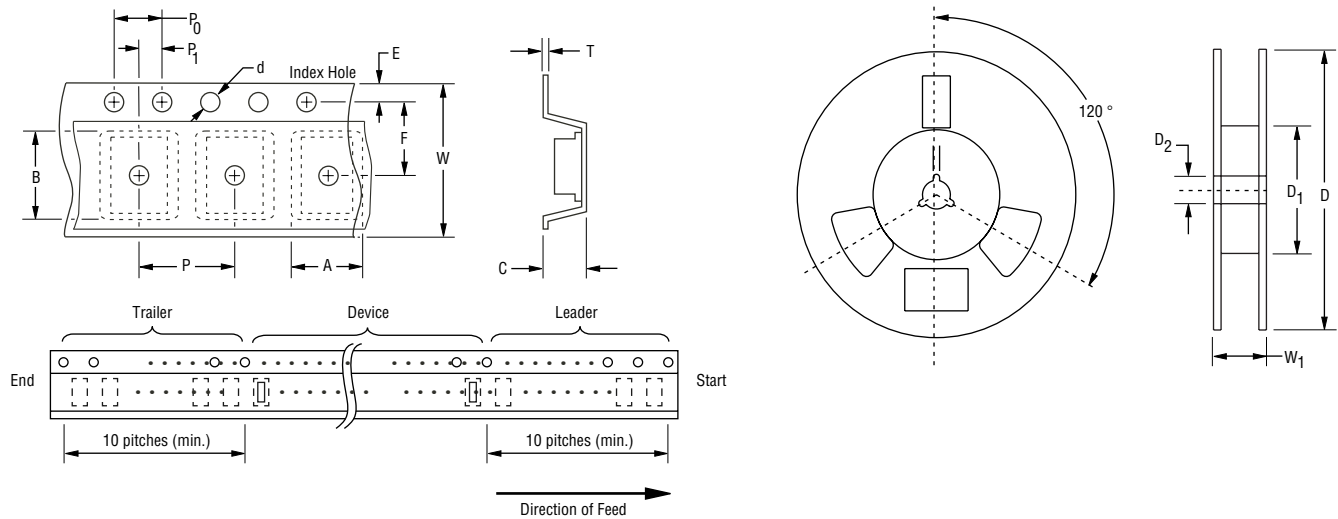

Item	Symbol	DFN-2
Carrier Width	A	$\frac{0.80 \pm 0.10}{(0.031 - 0.004)}$
Carrier Length	B	$\frac{1.20 \pm 0.10}{(0.047 - 0.004)}$
Carrier Depth	C	$\frac{0.70 \pm 0.10}{(0.027 - 0.004)}$
Sprocket Hole	d	$\frac{1.55 \pm 0.05}{(0.061 - 0.002)}$
Reel Outside Diameter	D	$\frac{178}{(7.008)}$
Reel Inner Diameter	D ₁	$\frac{50.0}{(1.969)}$ Min.
Feed Hole Diameter	D ₂	$\frac{13.0 \pm 0.20}{(0.512 - 0.008)}$
Sprocket Hole Position	E	$\frac{1.75 \pm 0.10}{(0.069 - 0.004)}$
Punch Hole Position	F	$\frac{3.50 \pm 0.05}{(0.138 - 0.002)}$
Punch Hole Pitch	P	$\frac{4.00 \pm 0.10}{(0.157 - 0.004)}$
Sprocket Hole Pitch	P ₀	$\frac{4.00 \pm 0.10}{(0.157 - 0.004)}$
Embossment Center	P ₁	$\frac{2.00 \pm 0.05}{(0.079 - 0.002)}$
Overall Tape Thickness	T	$\frac{0.20 \pm 0.10}{(0.008 - 0.004)}$
Tape Width	W	$\frac{8.00 \pm 0.20}{(0.315 - 0.008)}$
Reel Width	W ₁	$\frac{14.4}{(0.567)}$ Max.
Quantity per Reel	—	5,000

Specifications are subject to change without notice.
Customers should verify actual device performance in their specific applications.

REV. 12/15