

Using the UCC29950EVM-631

User's Guide



Literature Number: SLUUB69A
March 2015—Revised March 2015

Using the UCC29950EVM-631 300-W PFC/LLC Off-Line PSU Module

1 Introduction

The UCC29950EVM-631 evaluation module is a 300-W nominal, two-stage off-line converter. The EVM consists of a Continuous Conduction Mode (CCM) PFC input stage followed by a half-bridge LLC output and isolation stage. It provides a 12-V constant-voltage output with overload and short circuit protection. The UCC29950 incorporates a wide range of protection features to ensure safe system operation. The EVM may be operated without an external bias supply in Self Bias Mode, or with an external bias supply in Aux Bias Mode.

2 Description

This evaluation module uses the UCC29950 CCM PFC and LLC Combo Controller in a 300-W converter. The input accepts a voltage range of 90 V_{AC} to 265 V_{AC}. It has an output voltage of 12 V and a maximum output current of 25 A. Refer to the UCC29950 datasheet, (TI Literature Number SLUSC18), for full specs and details about the controller features. This EVM makes use of the device features to control a two-stage power supply that is rated for 300-W output power.

An overload timer tracks the extent and duration of overload and trips the overload protection when the current exceeds the over-current protection profile described in the datasheet. The overload protection turns the power stages off and then attempts restarts at 1 second intervals.

If the VCC level at the UCC29950 controller falls below the UVLO threshold the controller shuts down. It will attempt a restart when VCC recovers.

The over-temperature protection feature of the UCC29950 trips if the temperature of the device exceeds the thermal shutdown temperature. The device restarts once the temperature falls to the restart temperature.

The UCC29950 employs frequency dithering to reduce conducted emissions and therefore reduce the size and cost of the EMI filter.

This user's guide provides the schematic, component list, assembly drawing, art work and test set up necessary to evaluate the UCC29950EVM-631.

2.1 Features

UCC29950EVM-631 features include:

- AC Input Range 90 V_{AC} to 264 V_{AC}
- DC Output of 12 V, 25 A
- A CCM Boost Power Factor Correction Input Stage for High-Power Factor and High Efficiency
- An LLC Output Stage for High Efficiency
- Low Start-Up Current, with Integrated High-Voltage Start-Up Control
- On/Off Control of PFC Stage and PFC / LLC Stages
- Current Sense Inputs for PFC / LLC Overload Protection
- Line Brownout Protection
- PFC Bus Over-Voltage and Under-Voltage Protection
- X-Cap Discharge Function for Reduced System Standby Power Consumption
- Three Level LLC Over-Current Protection for Loads with High-Peak Power Requirements
- Short Circuit Protection
- Over Temperature Protection
- Operation in Self Bias or Aux Bias Modes

CAUTION

High voltage levels are present on the evaluation module whenever it is energized. Proper precautions must be taken when working with the EVM. The large bulk capacitor, C6, and the output capacitors C17, C20, C21, C22, C23, C24, C20 and C12, must be completely discharged before the EVM can be handled. Serious injury can occur if proper safety precautions are not followed.

2.2 Typical Applications

The UCC29950 is suited for use in mid-to-high power off-line converters. It is simple to use and has a low-external component count with extensive fault protection features.

- Televisions
- High Efficiency AC-to-DC server power supplies
- High Density Adapters
- 80+ SILVER PC Silver Box
- Gaming
- Audio
- Lighting Drivers
- Industrial Power

3 Electrical Performance Specifications

Table 1. UCC29950EVM-631 Performance Summary

PARAMETER		TEST CONDITION	MIN	TYP	MAX	UNIT
Input Characteristics						
V_{IN}	Input voltage		90	115/230	265	V_{AC}
f_{LINE}	Input frequency		47		63	Hz
$P_{IN(115V_no-load)}$	No-load input power	$V_{IN} = 115\text{ V}$ $f_{LINE} = 60\text{ Hz}$, $I_{OUT} = 0\text{ A}$		200		mW
$P_{IN(230V_no-load)}$	No-load input power	$V_{IN} = 230\text{ V}$ $f_{LINE} = 50\text{ Hz}$, $I_{OUT} = 0\text{ A}$		200		mW
$I_{IN(peak)}$	Peak input current	$V_{IN} = 90\text{ V}$, $f_{LINE} = 60\text{ Hz}$, $I_{OUT} = 25\text{ A}$		5.4		A
	AC turn-on voltage			80		V_{AC}
	AC turn-off voltage			75		
Output Characteristics						
V_{OUT}	Output voltage	$V_{IN(min)} < V_{IN} < V_{IN(max)}$, $f_{LINE(min)} < f_{LINE} < f_{LINE(max)}$, $I_{OUT(min)} < I_{OUT} < I_{OUT(max)}$	11.9	12.0	12.1	V_{DC}
$V_{OUT(line)}$	Line regulation	$V_{IN(min)} < V_{IN} < V_{IN(max)}$, $I_{OUT} = I_{OUT(max)}$		0.1%		
$V_{OUT(load)}$	Load regulation	$V_{IN} = 115\text{ V}_{AC}$, $f_{LINE} = 60\text{ Hz}$, $I_{OUT(min)} < I_{OUT} < I_{OUT(max)}$		0.1%		
		$V_{IN} = 230\text{ V}_{AC}$, $f_{LINE} = 50\text{ Hz}$, $I_{OUT(min)} < I_{OUT} < I_{OUT(max)}$		0.1%		
I_{OUT}	Output load current	$V_{IN(min)} < V_{IN} < V_{IN(max)}$, $f_{LINE(min)} < f_{LINE} < f_{LINE(max)}$	0		25	A
P_{OUT}	Output power	$V_{IN(min)} < V_{IN} < V_{IN(max)}$, $f_{LINE(min)} < f_{LINE} < f_{LINE(max)}$	0		300	W
$V_{RIPPLE(SW)}$	High-frequency output voltage ripple (measured with of a 10- μF aluminum electrolytic capacitor and a 1- μF high-frequency ceramic capacitor across the output terminals.)	$V_{IN} = 115\text{ V}_{AC}$, $f_{LINE} = 60\text{ Hz}$, $I_{OUT} = I_{OUT(max)}$		400		mV _{P-P}
		$V_{IN} = 230\text{ V}_{AC}$, $f_{LINE} = 50\text{ Hz}$, $I_{OUT} = I_{OUT(max)}$		400		mV _{P-P}
I_{OCC}	Steady-state output over current threshold	$V_{IN(min)} \leq V_{IN} \leq V_{IN(max)}$		28		A

Table 1. UCC29950EVM-631 Performance Summary (continued)

PARAMETER		TEST CONDITION	MIN	TYP	MAX	UNIT
System Characteristics						
$f_{SW(PFC)}$	Switching frequency – including ± 2 -kHz dither	$T_J = 25^\circ\text{C}$	87	100	109	kHz
PF	Power factor	$V_{IN} = 115\text{ V}_{AC}$, 60 Hz, $I_{OUT} = I_{OUT(max)}$	0.999			
		$V_{IN} = 230\text{ V}_{AC}$, 50 Hz, $I_{OUT} = I_{OUT(max)}$	0.995			
THD	Total harmonic distortion	$V_{IN} = 115\text{ V}_{AC}$, $f_{LINE} = 60\text{ Hz}$, $I_{OUT} = I_{OUT(max)}$	3%	10%		
		$V_{IN} = 230\text{ V}_{AC}$, $f_{LINE} = 50\text{ Hz}$, $I_{OUT} = I_{OUT(max)}$	6%	10%		
$f_{SW(LLC)}$	LLC stage switching frequency		70	110	350	kHz
η_{FL}	Full load efficiency	$V_{IN} = 115\text{ V}_{AC}$, $f_{LINE} = 60\text{ Hz}$, $I_{OUT} = I_{OUT(max)}$	88.3%			
		$V_{IN} = 230\text{ V}_{AC}$, $f_{LINE} = 50\text{ Hz}$, $I_{OUT} = I_{OUT(max)}$	90.5%			
η_{AV}	Average efficiency	$V_{IN} = 115\text{ V}_{AC}$, $f_{LINE} = 60\text{ Hz}$, $I_{OUT} = I_{OUT(max)}$	87.8%			
		$V_{IN} = 230\text{ V}_{AC}$, $f_{LINE} = 50\text{ Hz}$, $I_{OUT} = I_{OUT(max)}$	90.2%			
t_{AMB}	Ambient temperature		25			$^\circ\text{C}$

4 Schematic

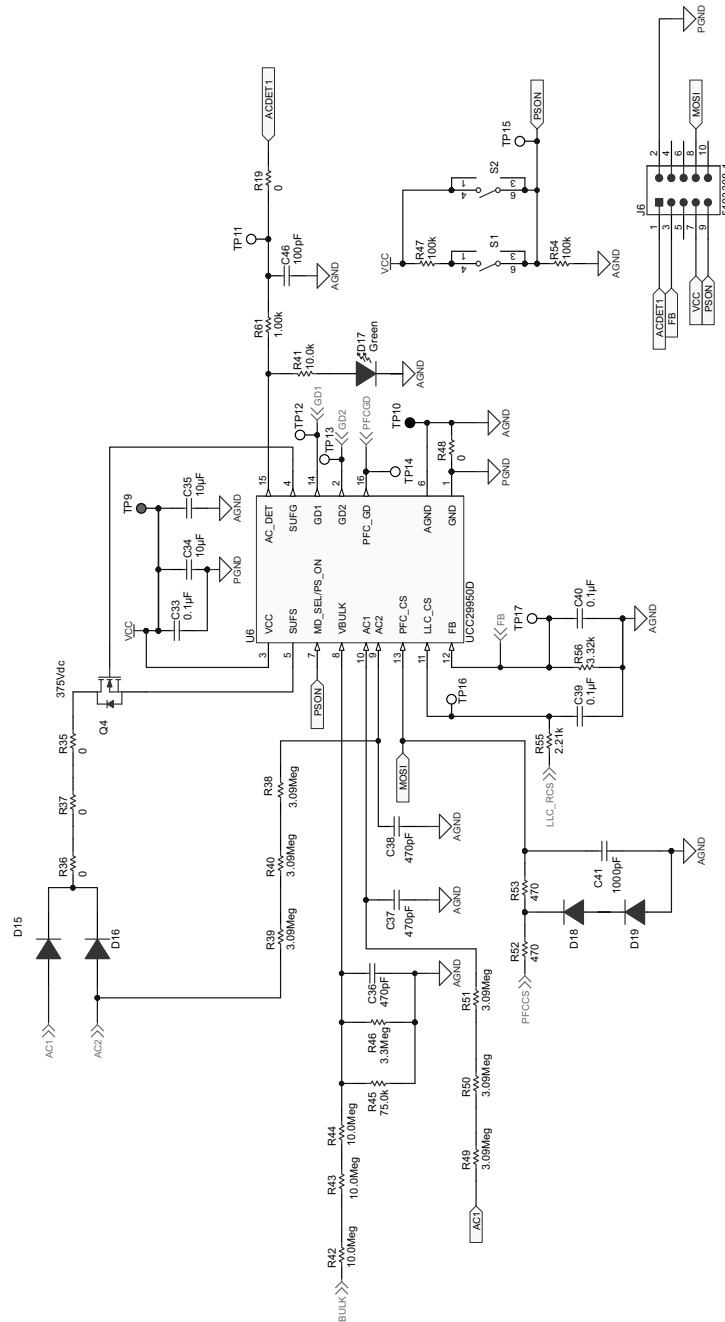

Figure 1. UCC29950EVM-631 Schematic - Control

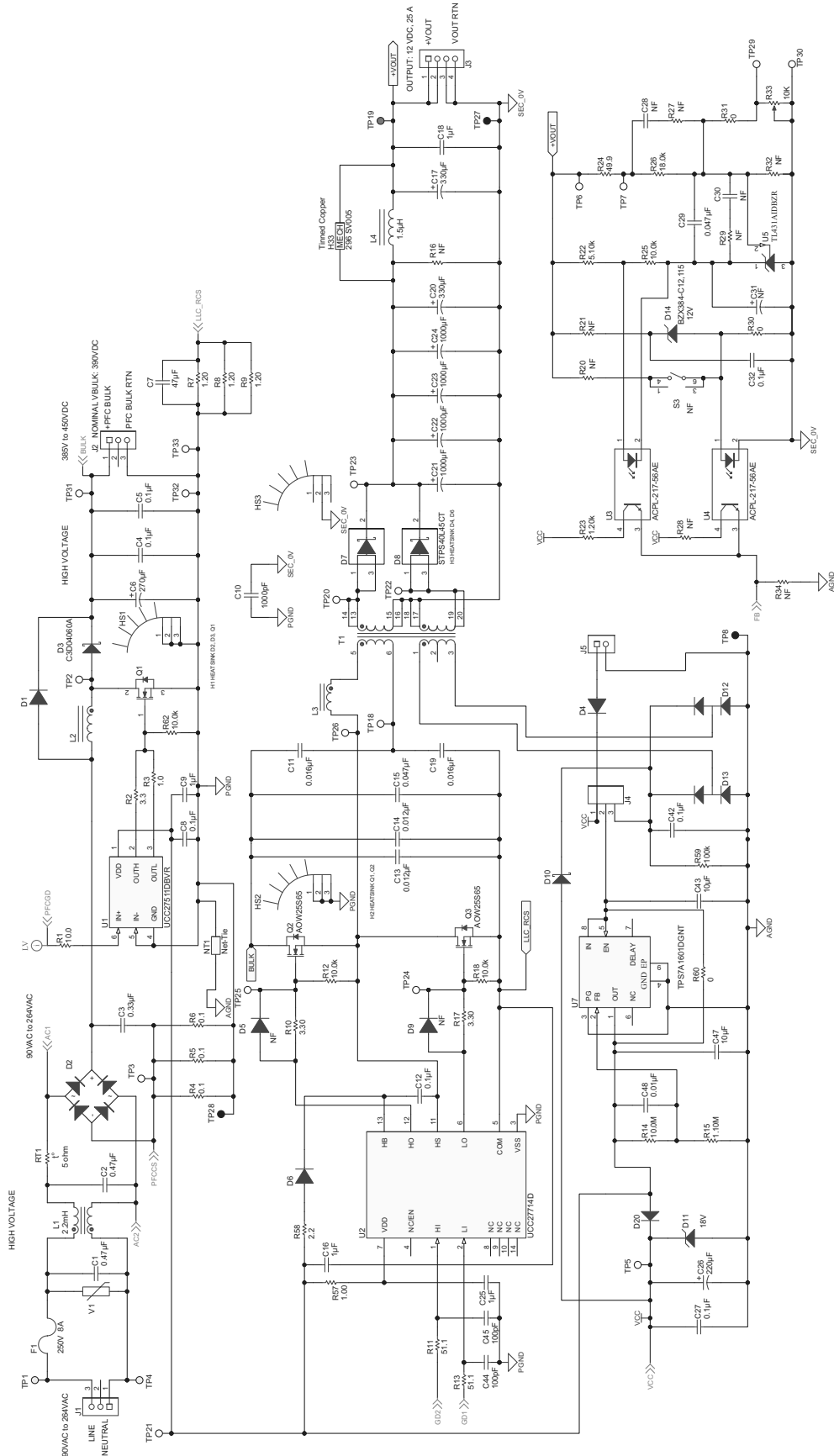

Figure 2. UCC2950EVM-631 Schematic - Power

5 Test Setup

Figure 3 shows the test setup recommended in order to evaluate the UCC29950EVM-631 in Self Bias Mode. Figure 4 shows the test setup recommended in order to evaluate the UCC29950EVM-631 in Aux Bias Mode.

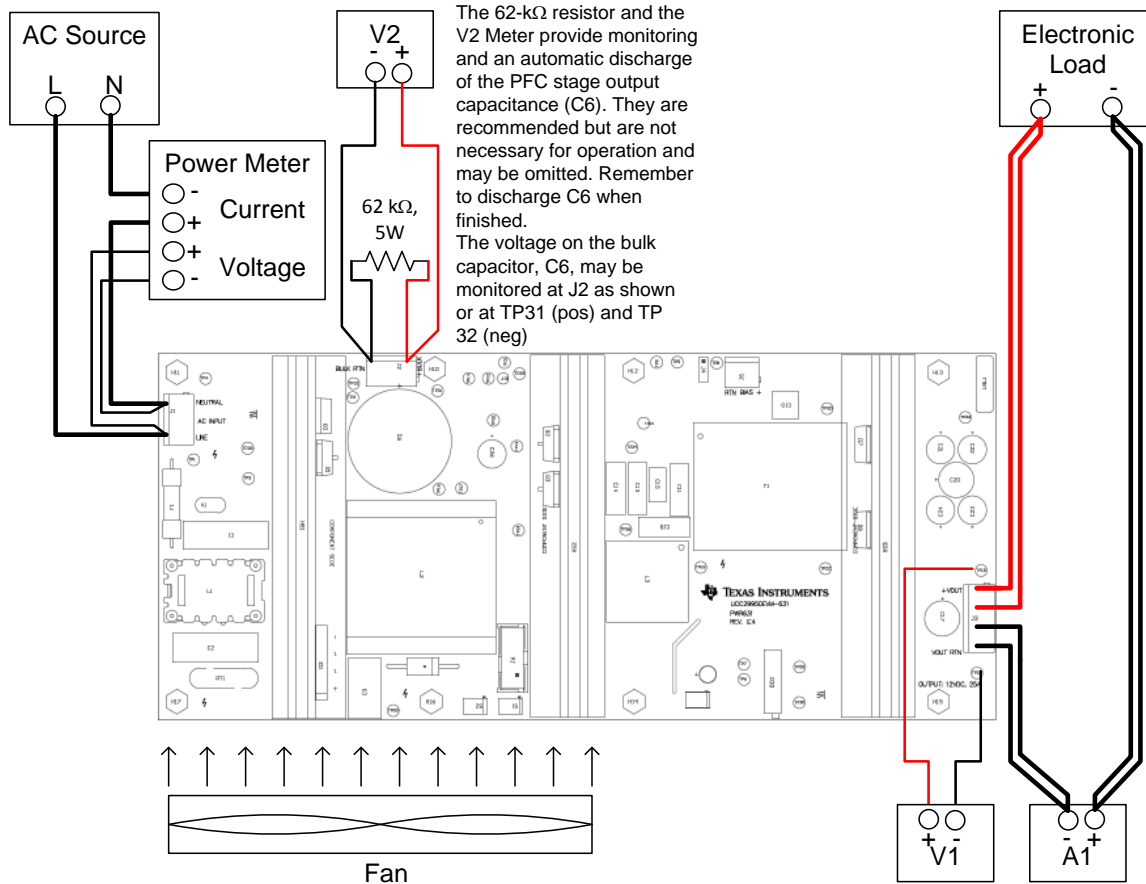

Figure 3. UCC29950EVM-631 Recommended Self Bias Test Set Up

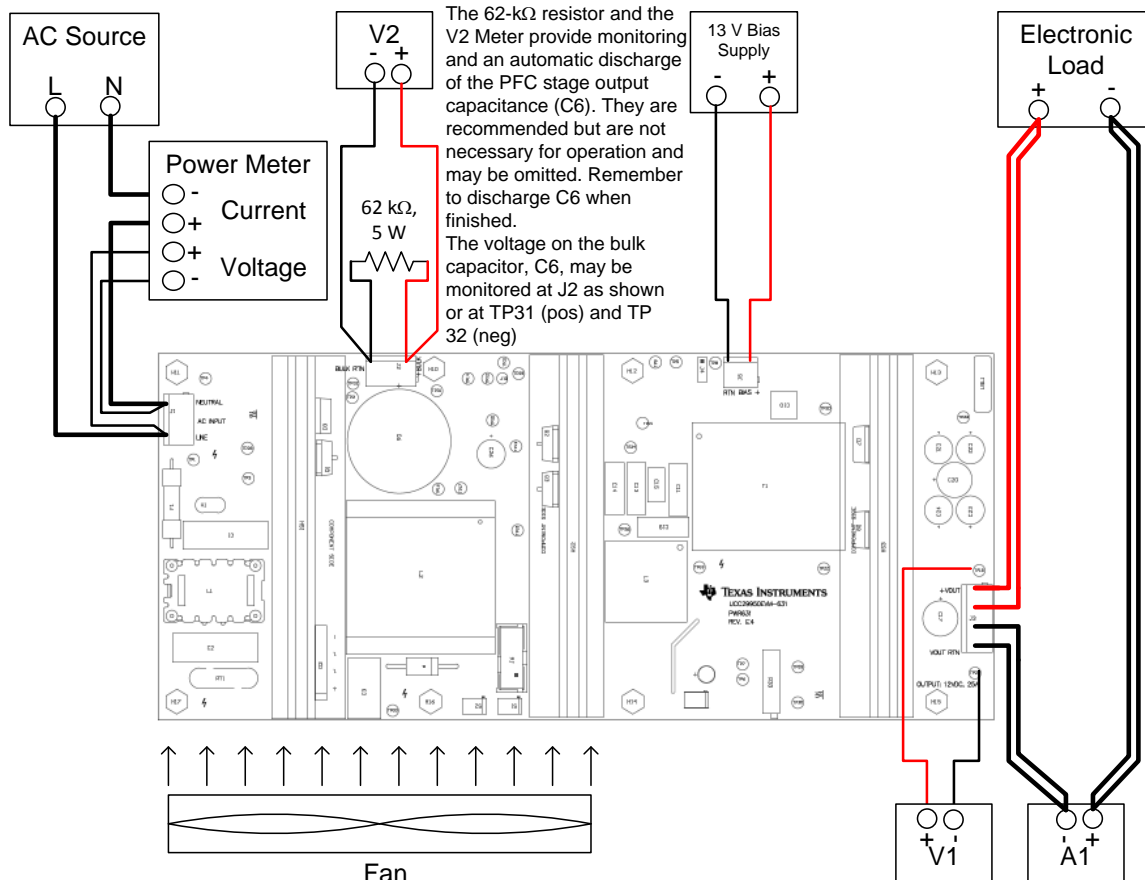

Figure 4. UCC29950EVM-631 Recommended Aux Bias Test Set Up

WARNING

High voltages that may cause injury exist on this evaluation module (EVM). Please ensure all safety procedures are followed when working on this EVM. Never leave a powered EVM unattended.

5.1 Test Equipment

AC Source: (for example, Hewlett Packard 6813B 300 V_{RMS}, 1750 VA AC Power Source/Analyzer) or VARIAC. The input voltage shall be a transformer isolated variable AC source capable of supplying between 90 V_{AC} and 264 V_{AC}, at 50 Hz and 60 Hz, at no less than 10-A peak.

13-V Bias Supply: The bias supply to the device shall be capable of supplying up to 13 V_{DC} at no less than 100 mA. Connect the bias supply to the negative and positive terminals of J5, shown in [Figure 3](#) and [Figure 4](#).

Output Load: One Electronic Load (for example TDI RBL 488 600-40-800). A programmable electronic load set to constant current mode and capable of sinking 0 A to 25 A at 12 V_{DC} shall be used. Connect the load to J3 as shown in [Figure 3](#) and [Figure 4](#).

Power Meter: For highest accuracy, a power analyzer shall be used to measure the input power, THD, and power factor. An example of such an analyzer is the Voltech PM100 Single Phase Power Analyzer or the Yokogawa WT210/WT230 Digital Power Meter.

Multimeters: For highest accuracy, the output voltage of the UCC29950EVM-631 shall be monitored by connecting a digital voltmeter, V1, directly across TP18 and TP27 with the positive terminal at TP18 and the negative terminal at TP27. A dc current meter, A1, should be placed in series with the electronic load for accurate output current measurements.

Oscilloscope: A digital or analog oscilloscope with 500-MHz scope probes is recommended.

Fan: A fan, capable of 200 LFM to 400 LFM, should be used to maintain component temperatures within safe operating ranges at all times during operation of the UCC29950EVM-631. Position the fan so as to blow along the length of the heatsink as shown in [Figure 3](#) and [Figure 4](#).

Recommended Wire Gauge: All electrical connections to the EVM must be made using appropriately rated wire. The line connections at J1, the PFC Output connections at J2 and the Aux Bias connections at J5 may be made using 22 AWG (0.5 mm²) Tri Rated wire. The output connections at J3 may be made with 16 AWG (1.5 mm²) Tri Rated wire. Use two conductors for the positive output and two for the negative output. The normal output load current of 25 A causes a voltage drop of about 250 mV per meter in both the positive and negative connections.

5.2 List of Test Points

Table 2. Test Point Functional Description

TEST POINT	NAME	DESCRIPTION
TP1	TP1	AC line input
TP2	TP2	Drain of PFC stage MOSFET
TP3	PFCCS	Signal across PFC current sensing resistor
TP4	TP4	AC neutral Input
TP5	VCC	VCC supply to the UCC29950 controller
TP6	VOUT	Loop injection point
TP7	TP7	Loop injection point
TP8	AGND	Analog (signal) ground
TP9	VCC	VCC rail for UCC29950
TP10	AGND	Analog (signal) ground
TP11	AC_DET	AC_DET signal output
TP12	GD1	LLC low-side MOSFET gate-drive output signal
TP13	GD2	LLC high-side MOSFET gate-drive output signal
TP14	PFC_GD	PFC stage MOSFET gate-drive output signal
TP15	PS_ON	MD_SEL/PS_ON signal
TP16	LLC_CS	LLC stage current sense input signal
TP17	FB	LLC stage feedback signal
TP18	TP18	LLC stage split capacitor
TP19	+VOUT	EVM positive output
TP20	TP20	LLC transformer output
TP21	VDD	VDD supply to MOSFET driver devices
TP22	TP20	LLC transformer output
TP23	TP23	LLC stage rectified output
TP24	TP24	LLC stage low-side MOSFET gate
TP25	TP25	LLC stage high-side MOSFET gate
TP26	TP26	LLC stage input switched node
TP27	VOUT RTN	EVM negative output
TP28	PGND	Power ground
TP29	TP29	Output adjust monitor
TP30	TP30	Output adjust monitor
TP31	VBULK	PFC stage output voltage (typical 385 V)
TP32	PGND	Power ground
TP33	PGND	Power ground

5.3 Power-Up/Power-Down Procedure: Self Bias Mode

The following test procedure is recommended primarily for power up and shutting down the evaluation Module in Self Bias mode. Never leave a powered EVM unattended for any length of time. Also, the unit should never be handled while power is applied to it.

WARNING

There are very high voltages present on the EVM. Some components reach temperatures above 50°C. Precautions must be taken when handling the board. Never operate the UCC29950EVM-631 without the fan running. Always make certain the bulk capacitor (C6) has completely discharged prior to handling the EVM.

1. Working at an ESD workstation, make sure that the ionizer is on before the EVM is removed from the protective packaging. Electrostatic smock and safety glasses should also be worn. Because voltages in excess of 400 V may be present on the EVM, do not connect the ground strap from the smock to the bench. If testing with a load, set the electronic load to Constant Current Mode.
2. Power Up: in Self Bias Mode
 - (a) Connect the equipment as shown in [Figure 3](#).
 - (b) Set the electronic load to 2 A.
 - (c) S1 to the 'off' position, switch toggle pointed to the heatsink as shown in [Figure 6](#).
 - (d) Set S2 to the 'on' position, switch toggle pointed away from the heatsink as shown in [Figure 7](#).
 - (e) Use the link to connect pin 2 to pin 3 of J4.
 - (f) Turn on the fan.
 - (g) Set the AC source voltage between 90 V_{AC} and 264 V_{AC}.
 - (h) Turn the AC source on.
 - (i) Verify that the output of the module is within regulation. Startup time may be several seconds.

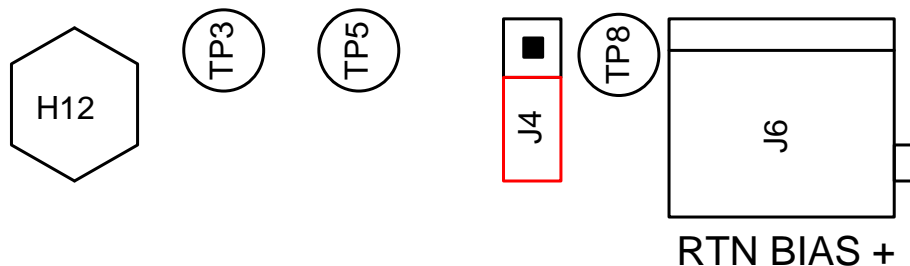
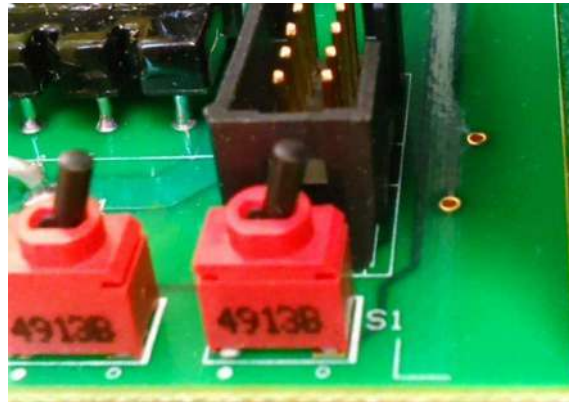
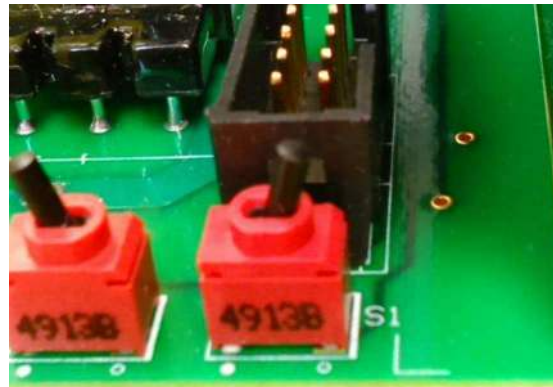

Figure 5. J4 Link Setting for Self Bias Mode



**Figure 6. S1 and S2 Settings for PFC and LLC Off
(Aux Bias Mode only)**



**Figure 7. S1 and S2 Settings for PFC and LLC on
(Aux Bias Mode and Self Bias Mode)**

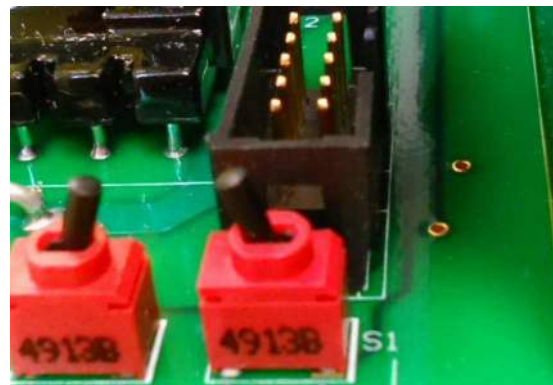

**Figure 8. S1 and S2 Settings for PFC Stage On, LLC Stage Off
(Aux Bias Mode only)**

5.4 Power-Up/Power-Down Procedure: Aux Bias Mode

The following test procedure is recommended primarily for power up and shutting down the evaluation module in Aux Bias Mode. Never leave a powered EVM unattended for any length of time. Also, the unit should never be handled while power is applied to it. The UCC29950EVM-631 is set at the factory to operate in Aux Bias Mode, with an external bias supply as shown in [Figure 4](#). Operation in Self Bias Mode, without an external bias supply is described in [Section 5.3](#).

WARNING

There are very high voltages present on the EVM. Some components reach temperatures above 50°C. Precautions must be taken when handling the board. Never operate the UCC29950EVM-631 without the fan running. Always make certain the bulk capacitor (C6) has completely discharged prior to handling the EVM.

1. Working at an ESD workstation, make sure that the ionizer is on before the EVM is removed from the protective packaging. Electrostatic smock and safety glasses should also be worn. Because voltages in excess of 400 V may be present on the EVM, do not connect the ground strap from the smock to the bench. If testing with a load, set the electronic load to Constant Current Mode.
2. Power Up in Aux Bias Mode:
 - (a) Connect the equipment as shown in [Figure 4](#).
 - (b) Set the electronic load to 2 A.
 - (c) Set the two switches, S1 and S2 to the 'off' position, switch toggle pointed to the heatsink as shown in [Figure 6](#).
 - (d) Check that the link connects pin 1 to pin 2 of J4.
 - (e) Turn on the 13-V bias supply.
 - (f) Set S2 to the 'on' position. switch toggle pointed away from the heatsink as shown in [Figure 7](#).
 - (g) Turn on the fan.
 - (h) Set the AC source voltage between 90 V_{AC} and 264 V_{AC}.
 - (i) Turn the AC source on.
 - (j) Verify that the output of the module is within regulation.

NOTE: The Power Up procedure given above will always work. However, providing that the bias supply has not been interrupted and S2 is in the 'on' position, the EVM will power up and down as the AC source is turned on and off.

5.5 Equipment Shutdown

1. To quickly discharge the output capacitors, make sure there is a load greater than 0 A on the EVM.
2. Turn off the AC source.
3. Turn off the bias source if operating in Aux Bias Mode.
4. Using the voltmeter at V2, check that the voltage on the bulk capacitor, C6, has fallen to a safe level.

6 UCC9950EVM-631 Feature Testing

6.1 AC Input Range 90 V_{AC} to 264 V_{AC}

The EVM may be operated in both Self Bias and Aux Bias Modes and at any load over the full universal input voltage range, from 90 V_{AC} to 264 V_{AC}. The EVM turns on at a voltage slightly below 90 V_{AC}, typically at around 80 V. PFC switching action halts if the line voltage gets too low, typically below 75 V. It is safe to apply up to 300 V_{AC} to the input but THD increases significantly due to direct conduction into the bulk capacitor at the peak of the line cycle.

6.2 Load Regulation of the DC Output

Use the test set up shown in shown in [Figure 3](#) (Self Bias Mode) and [Figure 4](#) (Aux Bias Mode) to test the load regulation of the EVM.

1. Set the AC source to a constant voltage between 90 V_{AC} and 264 V_{AC}.
2. Vary the load so that the output current varies from 1 A up to 25 A, as measured on DMM A1.
3. Observe that the output voltage on DMM V1 remains within 0.1% of the full-load regulation value.

6.3 Line Regulation of the DC Output

Use the test set up shown in [Figure 3](#) (Self Bias Mode) and [Figure 4](#) (Aux Bias Mode) to test the Line regulation of the EVM.

1. Set the load to sink the full-load current, 25 A.
2. Vary the AC source from 90 V_{AC} to 264 V_{AC}.
3. Observe that the output voltage on DMM V1 stays within 0.1% of the output voltage regulation value.

6.4 Power Factor

The power meter may be used to monitor the power factor (PF) of the line current and the input power taken by the EVM. The PF is very close to 1.0 under most operating conditions. At very light loads, where the EVM enters a burst mode of operation the PF is lower.

6.5 Efficiency

Use the output current (A1) and output voltage (V1) meters to calculate the output power and hence the overall unit efficiency over a wide range of operating conditions. The EVM has a very high end-to-end full-load efficiency of more than 90% at 230 V and more than 88% at 115 V. Typical results are shown in [Figure 12](#) and [Figure 13](#).

6.6 Low Start-Up Current, with Integrated High-Voltage Start-Up Control

In Self Bias Mode only. Observe the VCC startup voltage waveform at TP9 during a Self-Bias startup. The capacitor is initially charged to approximately 18 V through Q4 and the SUFS pin of the UCC29950. At that point Q4 is turned off and the EVM starts. The action of turning Q4 off eliminates the losses in the startup circuit and this helps to reduce the no-load power dissipation of the system.

6.7 On/Off Control of PFC Stage and PFC/LLC Stages

In Aux Bias Mode only. When the EVM is operating in Aux Bias Mode the switches S1 and S2 may be used to turn the LLC stage off and on or turn both the LLC and PFC stages off and on. Add a 'scope probe to the MD_SEL/PS_ON pin at TP15. Get the EVM operating normally in Aux Bias Mode as described earlier, TP15 should be at 0 V and then go to VCC when S2 is put in the 'on' position, see [Figure 7](#). Then turn both stages off by flipping S2 back into the 'off' position, see [Figure 6](#). TP15 should go from VCC to 0 V. Then, turn the PFC stage alone on by flipping S1 into the 'on' position, see [Figure 8](#). TP15 should go to approximately VCC/2. Observe that the LLC stage has stopped ($V_{OUT} = 0$ V) and the PFC stage is running (V2 monitoring the bulk capacitor). Flip S2 into the 'on' position again (S1 may be left in the 'on' position), TP 15 should go to VCC and the LLC stage will start. This feature allows the user additional flexibility in system design. Be careful when operating these switches because hazardous voltages exist on the PCB.

6.8 Three Level LLC Over-Current Protection for Loads with High-Peak Power Requirements

The UCC29950 includes a three level over current protection feature on the LLC stage which allows for short term overloads beyond the normal current limit point (28A).

Increase the load on the output slowly, the over current protection will operate at about 28 A. The OCP feature stops the LLC operating and then tries to restart it after about 1 second. The 28 A overload protection is triggered by the OCP1 level and will trip after a nominal 52 ms delay.

Set the electronic load to apply an overload load transient (25 A to 33 A to 25 A) for a short period (20 ms). This will not trip the over current protection. Increase the time period incrementally until the OCP1 over current protection is activated.

The second OCP level (OCP2) operates at about 42 A after 10 ms. This should be observed in the same way as the OCP1. Set the load to apply an overload load transient (25 A to 50 A to 25 A) for a short period 5 ms. This will not trip the over current protection. Increase the time period incrementally until the over current protection is activated as before.

The third OCP level (OCP3) provides protection against output short circuits.

6.9 Short Circuit Protection

The UCC29950 also includes short circuit protection which operates immediately the signal at the LLC_CS pin exceeds 900 mV (OCP3). Test this by applying a short circuit to the EVM output terminals, the LLC stage stops immediately. The best way to observe this is by monitoring one of the LLC gate drive signals at TP12 and the LLC_CS signal at TP16. Switching action will stop immediately if the signal at TP16 exceeds 900 mV.

6.10 Current Sense Inputs for PFC Overload Protection

The PFC stage current sense input is used as an input to the control loop in the UCC29950. The UCC29950 uses the PFC_CS signal to shape the input current during the line cycle. It also has a current and power limiting function as explained in the 'PFC Stage Current Sensing' and 'Input Power Limit' sections of the data sheet. The operating point for both these features is set at a level which is higher than the point at which the LLC OCP protections operate so they are not normally triggered.

6.11 Line Brownout Protection

The UCC29950 includes brownout protection which operates if the line voltage falls below the minimum operating voltage, typically 75 V_{AC}. The UCC29950 rides through or ignores short term interruptions of up to approximately 32 ms.

Set the AC source so that it provides a correct line voltage then goes to 0 V for a half cycle, the EVM operation is uninterrupted. Increase the length of the drop out, eventually the EVM will shut down (typically 32 ms), this is a non-latching shutdown so it attempts to restart after a delay of about 1 second.

Repeat this process but have the AC source drop the input voltage to a low value (60 V_{AC} for example). Again, the system ignores short dropouts but turns off for longer dropouts.

6.12 X-Cap Discharge Function for Reduced System Standby Power Consumption

This feature can be tested by observing the voltage across the X-Capacitor when the line is disconnected.

NOTE: Turning the output off on most AC sources sets the source to 0 V.

It is best to use a mechanical switch or relay to disconnect the line voltage from the EVM. Alternatively, wire a suitably rated line socket and plug into the line cord and use that to disconnect the EVM. Put a differential scope probe from TP1 to TP4.

The operation of the X-Cap feature is quite complex and is described in the 'Active X-Cap Discharge' section of the UCC29950 data sheet.

6.13 Output Voltage Ripple

An external 10- μ F aluminum capacitor and 1- μ F ceramic noise decoupling capacitor network should be connected to the output to measure the output ripple and noise. This network may be connected across the +VOUT and RTN terminals of J3. The loop area between the scope probe tip and ground should be minimized for accurate ripple and noise measurements.

7 Performance Data and Typical Characteristic Curves

Figure 12 through Figure 33 present typical performance curves for the UCC9950EVM-631.

7.1 PFC Stage Loop Stability

The UCC29950 uses a new Hybrid Average Current control method. The loop compensation is implemented digitally thus eliminating the need for external compensation components. The Bode Plots below were taken from a typical EVM and show a loop crossover frequency of 9Hz with a phase margin of greater than 60°.

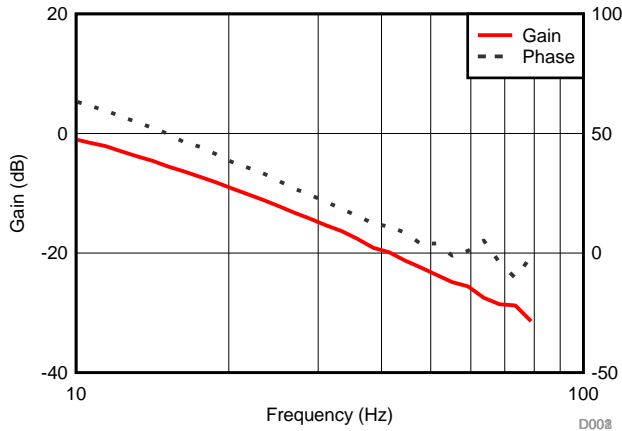

Figure 9. PFC Loop Gain/Phase at 300 W, 115 V

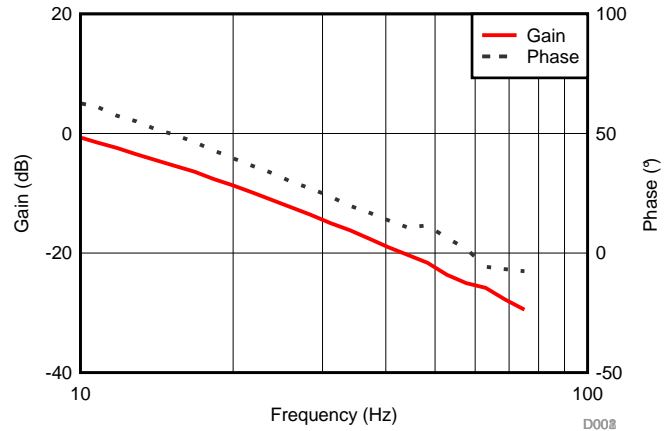

Figure 10. PFC Loop Gain/Phase at 300 W, 230 V

7.2 LLC Stage Loop Stability

The gain and phase characteristic of the LLC stage is dominated by the external components in the feedback loop rather than by the UCC29950 itself. The Bode Plots below were taken from a typical EVM and show a loop crossover frequency of approximately 1.1kHz with a phase margin of greater than 45°.

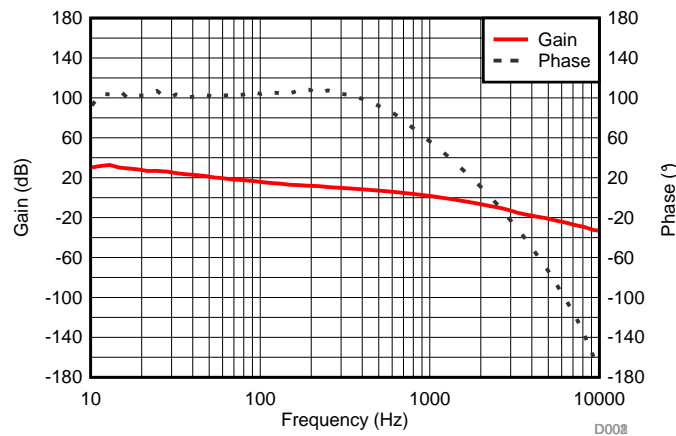

Figure 11. Gain/Phase vs. Frequency

7.3 Efficiency

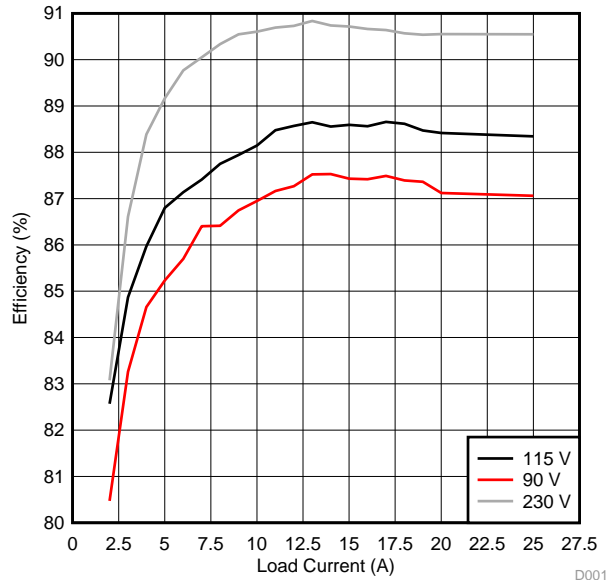

Figure 12. UCC29950EVM-631 Typical Efficiency (as a function of line voltage and current)

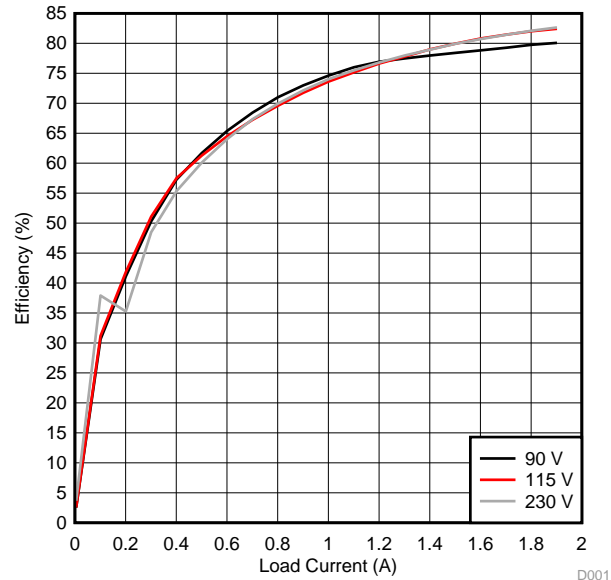

Figure 13. UCC29950EVM-631 Typical Light-Load Efficiency (as a function of line voltage and current)

The UCC29950EVM-631 also meets the requirements of 80PLUS Silver with good margin and is close to meeting the requirements of 80PLUS Gold.

Table 3. UCC29950EVM-631, Typical Average Efficiency

V_{IN} (V)	F (Hz)	% LOAD	P_{IN} (W)	P_{OUT} (W)	EFFICIENCY (%)	PF	AVG EFF (%)
115	60	100	345.3	300.0	86.9	0.999	88.0
		75	256.7	225.0	87.6	0.999	
		50	168.0	150.0	89.2	0.997	
		25	84.95	75.0	88.3	0.990	
230	50	100	337.0	300.0	89.0	0.995	90.1
		75	250.7	225.0	89.7	0.990	
		50	164.4	150.0	91.3	0.982	
		25	83.02	75.0	90.3	0.958	

7.4 Total Harmonic Distortion

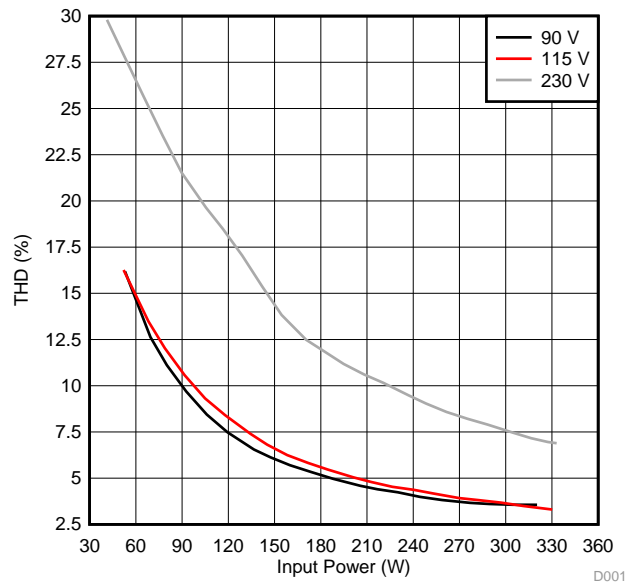

Figure 14. UCC29950EVM-631 Total Harmonic Distortion (as a function of line voltage and load current)

7.5 Current Harmonics

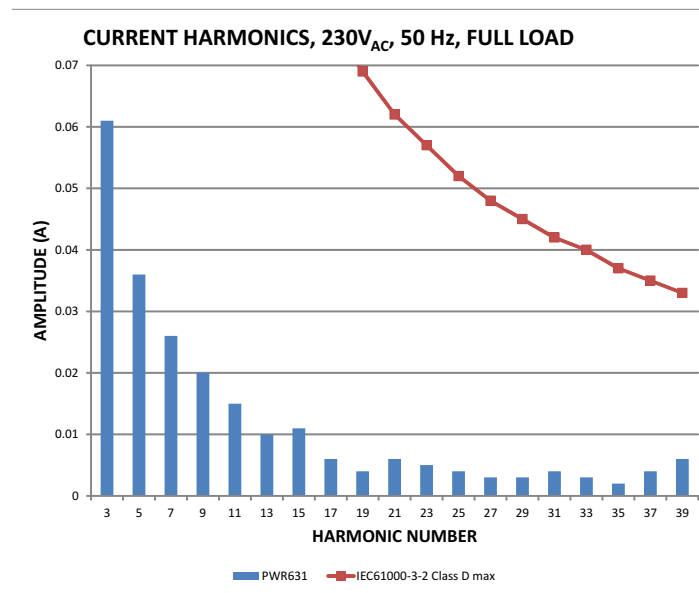

Figure 15. UCC29950EVM-631 Current Harmonics (230-V_{AC}, 50-Hz input, full load)

7.6 Line/Load Regulation

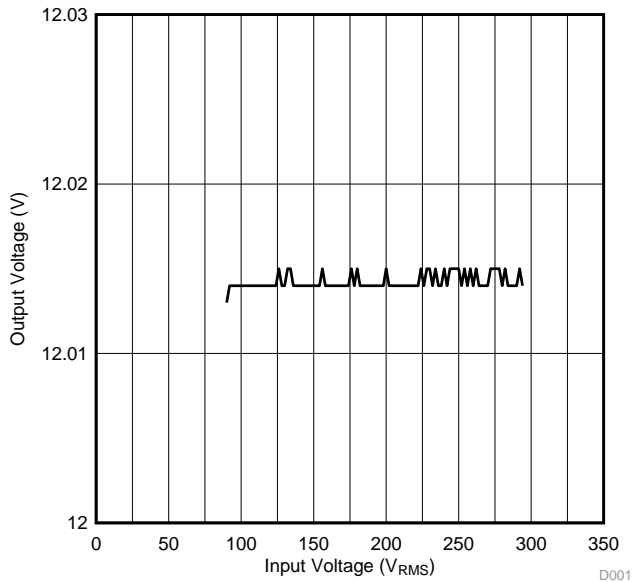

Figure 16. Line Regulation vs Input Voltage

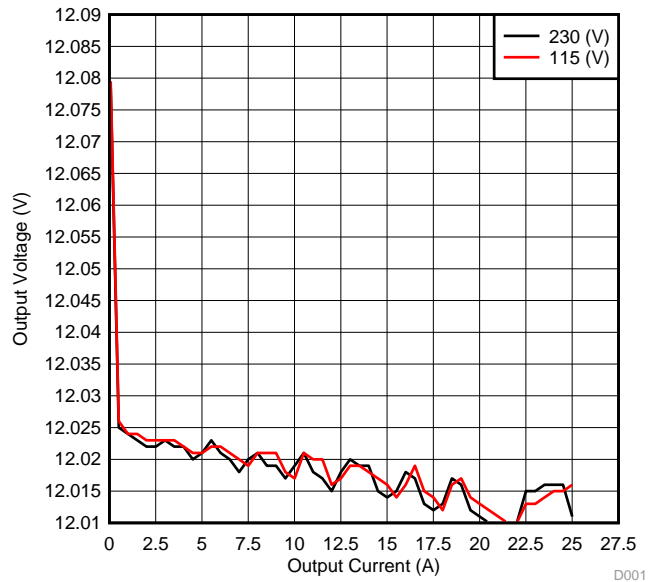

Figure 17. Load Regulation vs Output Current

7.7 Power Factor

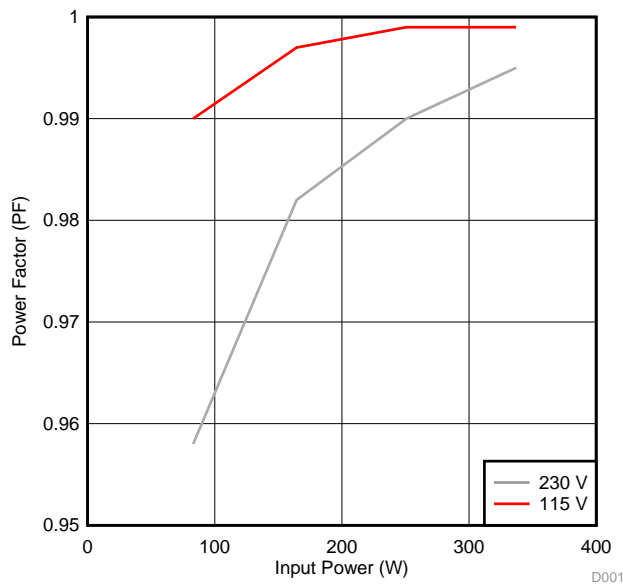

Figure 18. Power Factor vs Input Power

7.8 Input Current

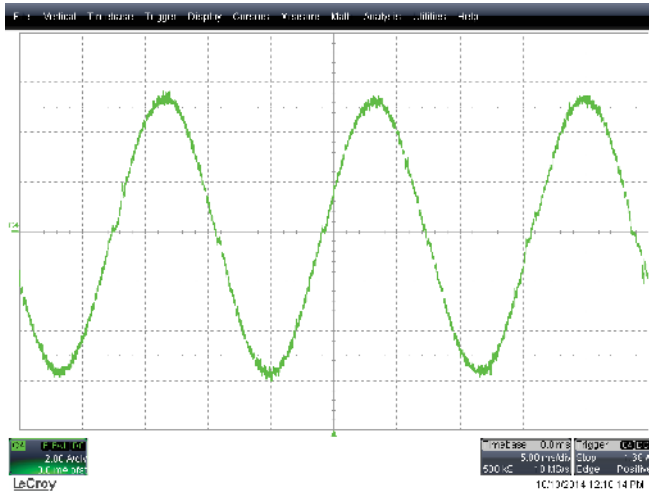

Figure 19. UCC29950EVM-631 Input current (90-V_{AC}, 60-Hz, full load, 2 A/div.)

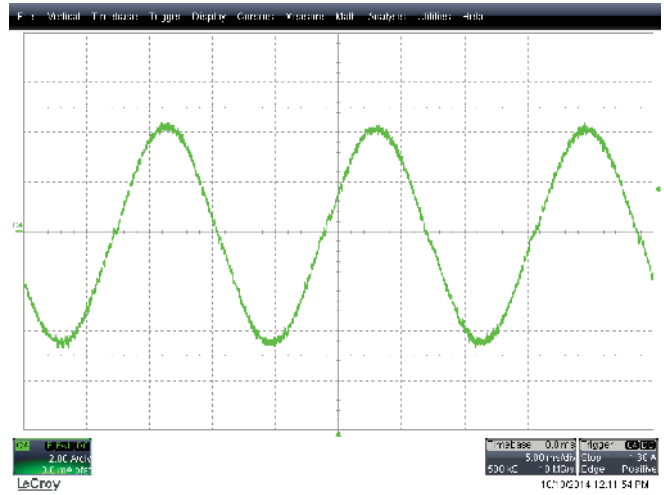

Figure 20. UCC29950EVM-631 Input Current (115-V_{AC}, 60-Hz, full load 2 A/div.)

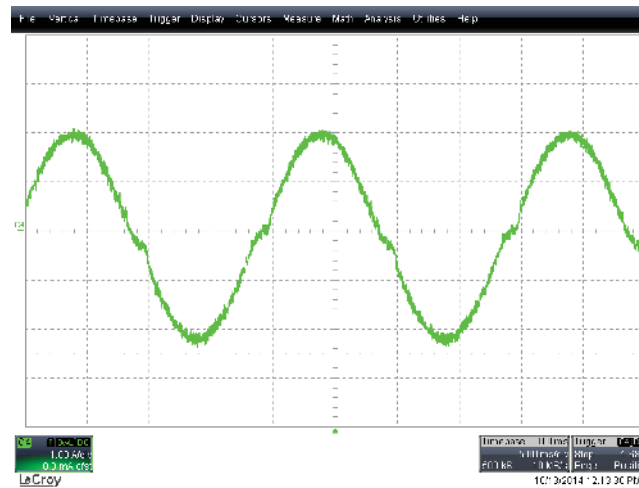

Figure 21. UCC29950EVM-631 Input Current (230-V_{AC}, 50-Hz, full load 1 A/div.)

7.9 Output Voltage Ripple

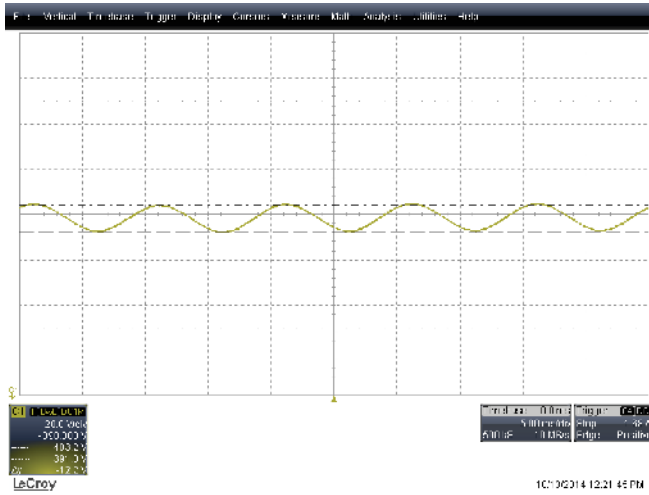

Figure 22. UCC29950EVM-631 V_{BULK} Voltage Ripple (115- V_{AC} , 60-Hz input, full load)

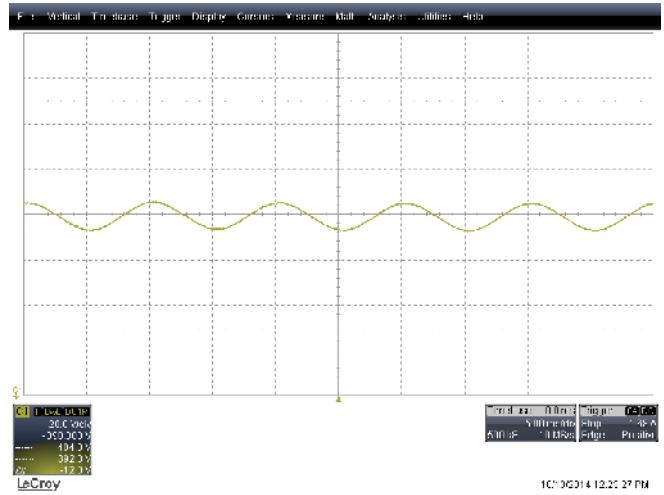

Figure 23. UCC29950EVM-631 V_{BULK} Voltage Ripple (230- V_{AC} , 50-Hz input, full load)

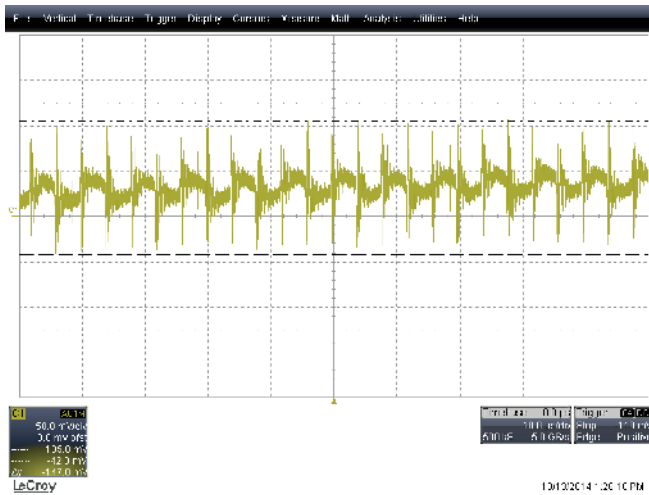

Figure 24. UCC29950EVM-631 Output Noise (115- V_{AC} , 60-Hz input, full load)



Figure 25. UCC29950EVM-631 Output Noise (230- V_{AC} , 50-Hz input, full load)

7.10 Light-Load Performance

At light loads, typically below 1 A, the UCC29950-PWR631 EVM enters a burst mode of operation. As the load on the power stages reduces, eventually a point is reached where the controller can no longer maintain continuous switching operation without allowing V_{OUT} to increase. In burst mode, the controller does not operate continually but instead delivers short bursts of energy to the output separated by longer intervals during which no energy transfer occurs. This allows the controller to maintain the correct average output voltage – at the expense of an increase in output ripple. Typical output ripple performance is shown in Figure 26 and Figure 27 below. The burst interval and the output ripple amplitude depends on whether the EVM is operating in Aux Bias or Self Bias Mode.



Figure 26. V_{OUT} , No Load, Aux Bias, Burst Interval is 340 ms, ΔV_{OUT} is 400 mV



Figure 27. V_{OUT} , No Load, Self Bias, Burst Interval is 4-s intervals, $\Delta V_{OUT} = 1.5$ V

7.11 Output Noise Measurements

All output noise measurements have been taken directly at output connector J3.



Figure 28. DC Coupled, V_{OUT} 0 A, Aux Bias Burst is Approximately 8-ms Long, Burst Rep Interval is Approximately 340 ms

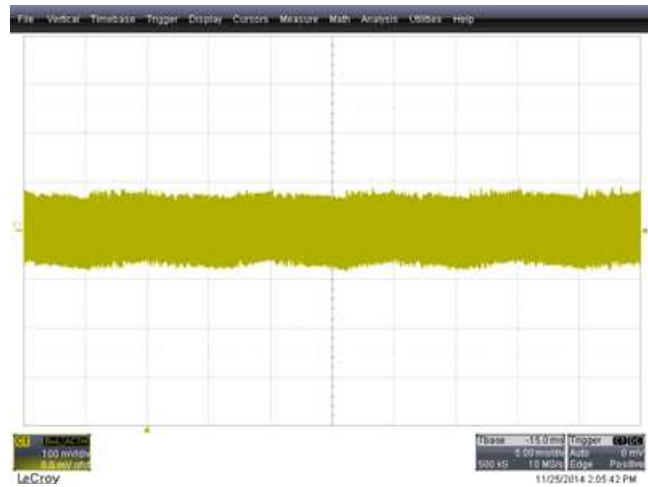

Figure 29. V_{OUT} , 1 A, Aux Bias

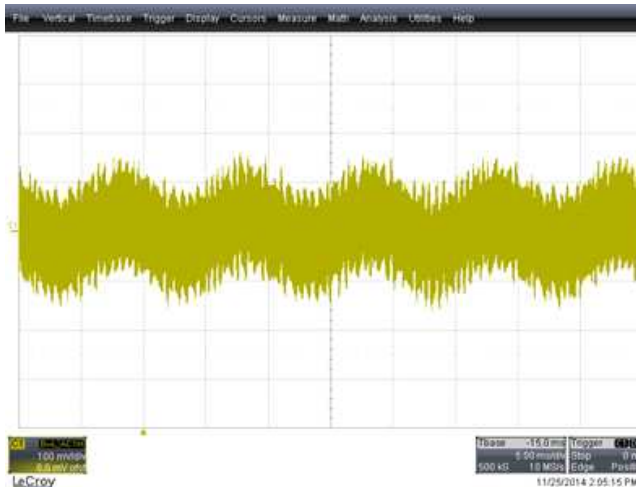

Figure 30. V_{OUT} 25 A, Aux Bias



Figure 31. V_{OUT} 25 A, Aux Bias

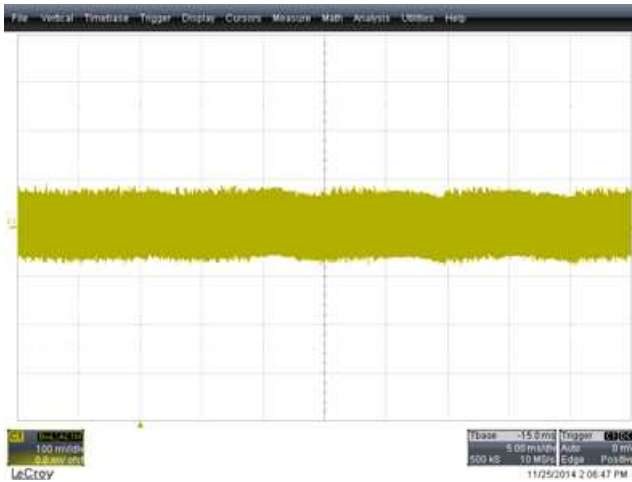

Figure 32. V_{OUT} , 1 A, Self Bias

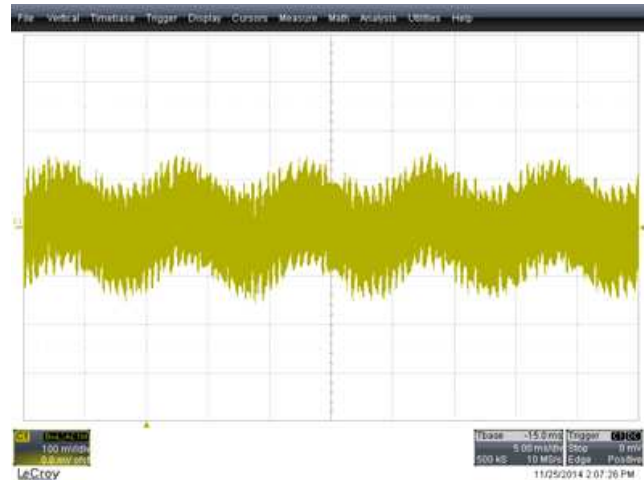

Figure 33. V_{OUT} 25 A, Aux Bias

Table 4. No-Load Input Power

LINE	BIAS MODE	AUX BIAS POWER	NO LOAD INPUT POWER
90 V_{AC}	Self Bias		325 mW
115 V_{AC}	Self Bias		390 mW
230 V_{AC}	Self Bias		660 mW
264 V_{AC}	Self Bias		745 mW
90 V_{AC}	Aux Bias	130 mW	254 mW + 130 mW = 384 mW
115 V_{AC}	Aux Bias	130 mW	200 mW + 130 mW = 330 mW
230 V_{AC}	Aux Bias	130 mW	160 mW + 130 mW = 290 mW
264 V_{AC}	Aux Bias	130 mW	175 mW + 130 mW = 305 mW

8 EVM Assembly Drawing and PCB Layout

Figure 34 through Figure 37 show the design of the UCC29950EVM-631 printed circuit board.

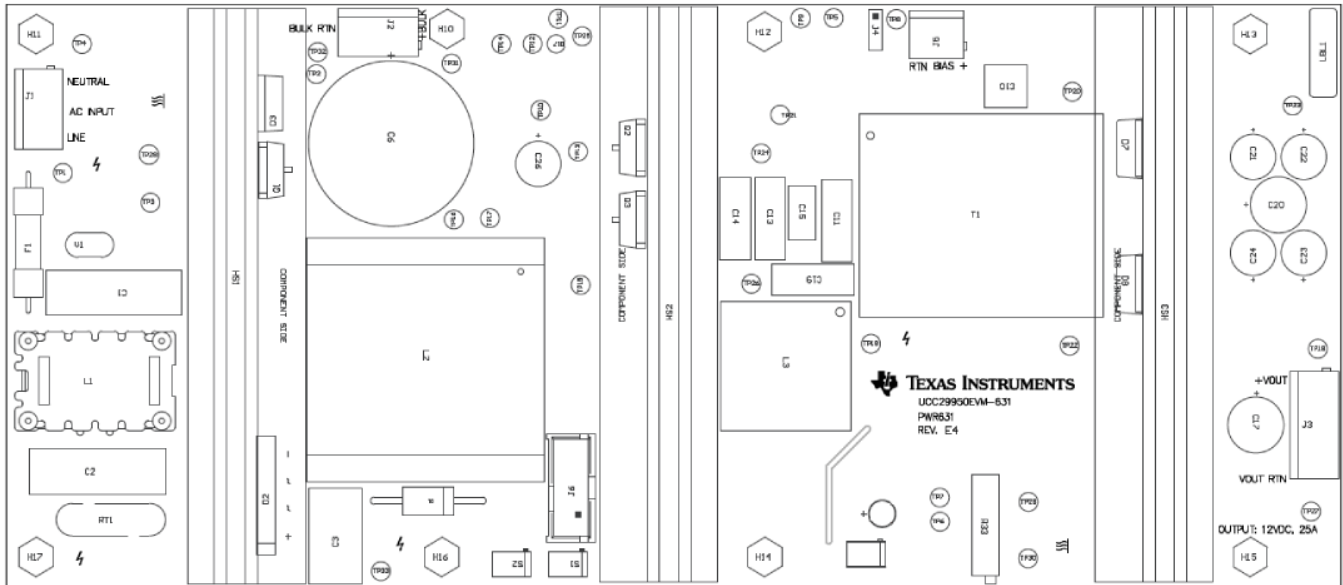

Figure 34. UCC29950EVM-631 Top Layer Assembly Drawing (top view)

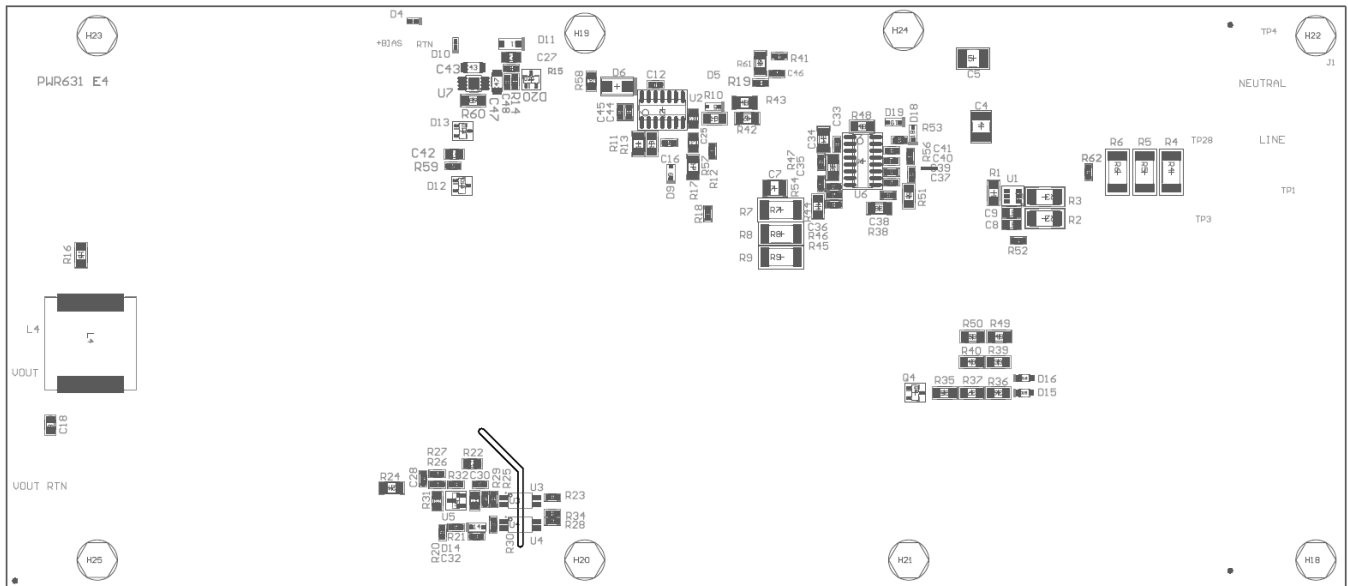

Figure 35. UCC29950EVM-631 Bottom Layer Assembly Drawing (bottom view)

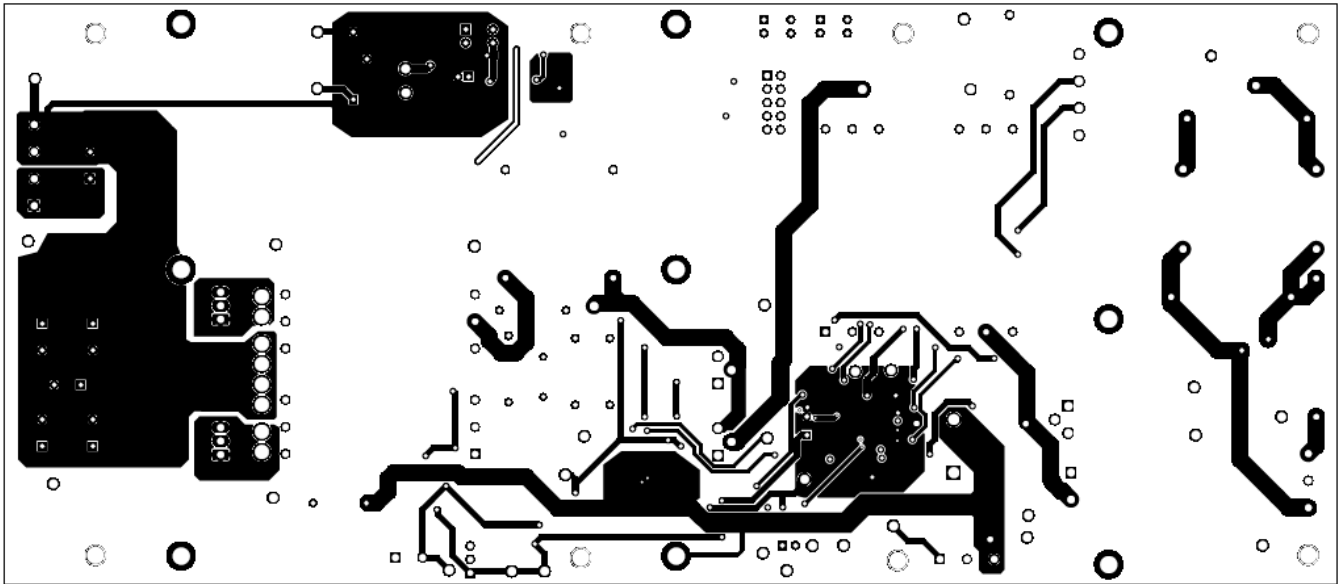

Figure 36. UCC29950EVM-631 Top Copper (top view)

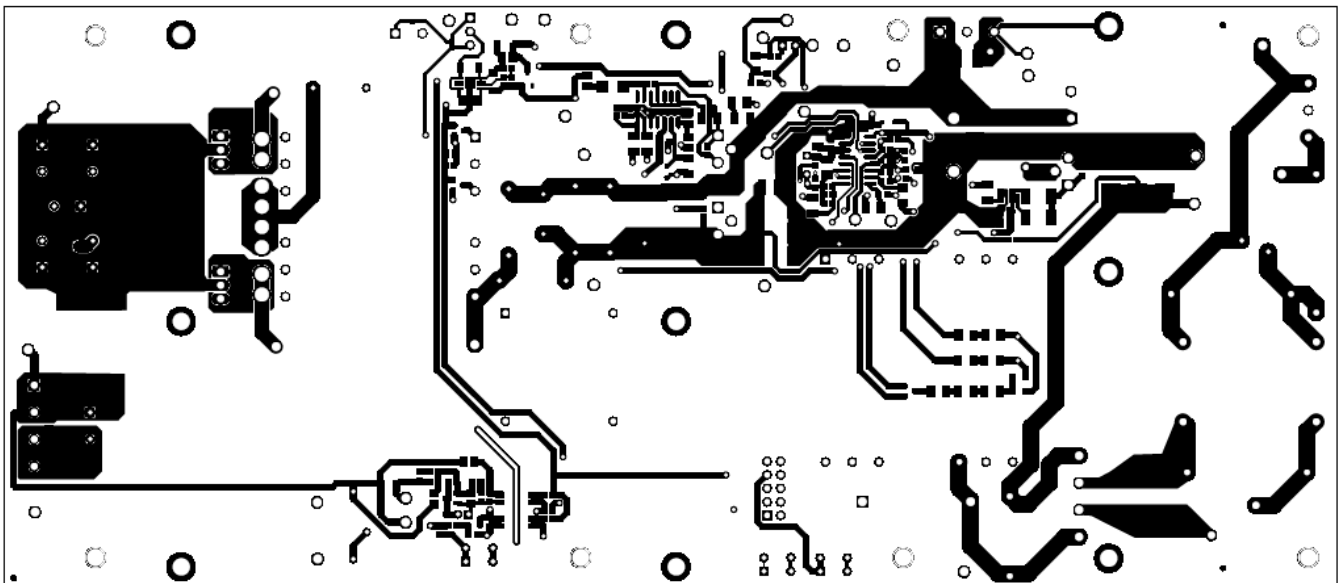

Figure 37. UCC29950EVM-631 Bottom Copper (bottom view)

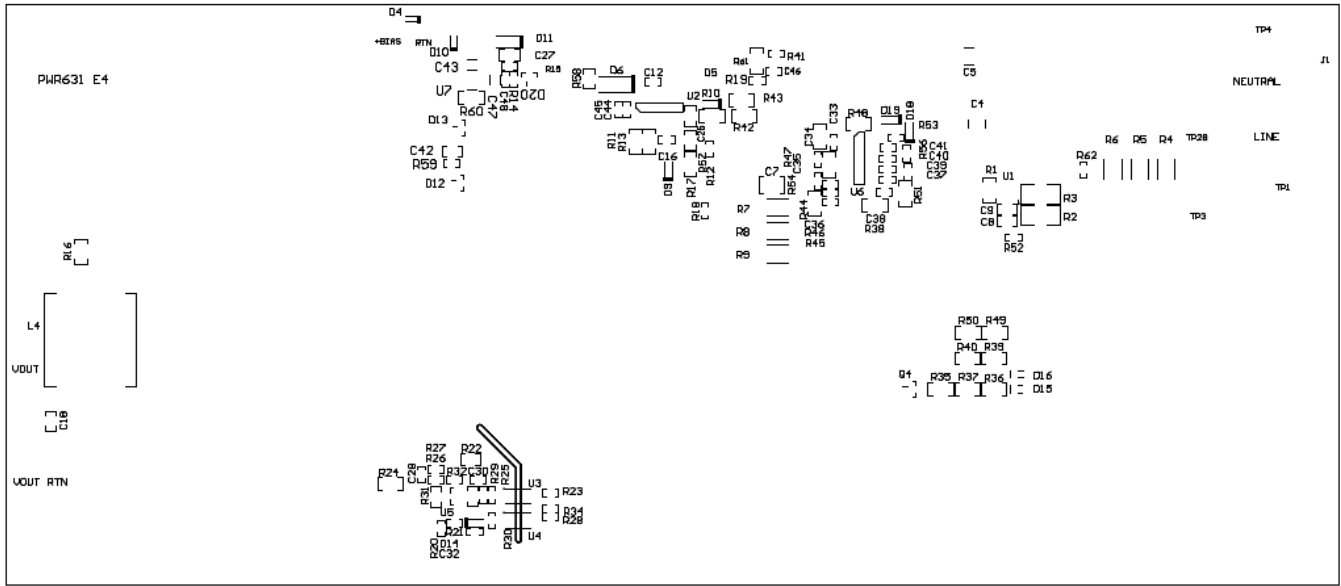

Figure 38. Components Assembly

9 List of Materials

Table 5 lists the UCC29950EVM-631 components according to the schematic shown in Figure 1 and Figure 2.

Table 5. UCC29950EVM-631 List of Materials

QTY	REF DES	DESCRIPTION	MFR	PART NUMBER
2	C1, C2	Capacitor, film, 0.47 μ F, 275 V, \pm 20%, TH	Panasonic	ECQ-U2A474ML
1	C3	Capacitor, film, 0.33 μ F, 275 V, \pm 20%, TH	Panasonic	ECQ-U2A334ML
2	C4, C5	Capacitor, ceramic, 0.1 μ F, 630 V, \pm 10%, X7R, 1812	MuRata	GRM43DR72J104KW01L
1	C6	Capacitor, aluminum, 270 μ F, 450 V, \pm 20%, TH	Cornell Dubilier	380LQ271M450K022
1	C7	Capacitor, ceramic, 47 μ F, 6.3 V, \pm 10%, X7R, 1210	MuRata	GRM32ER70J476KE20L
3	C8, C27, C42	Capacitor, ceramic, 0.1 μ F, 50 V, \pm 5%, X7R, 0805	AVX	08055C104JAT2A
2	C9, C18	Capacitor, ceramic, 1 μ F, 50 V, \pm 10%, X7R, 0805	MuRata	GRM21BR71H105KA12L
1	C10	Capacitor, ceramic, 1000 pF, 250 V, \pm 20%, E, Disc, 8 mm x 12 mm	MuRata	DE1E3KX102MA5BA01
2	C11, C19	Capacitor, film, 0.016 μ F, 630 V, \pm 5%	Panasonic	ECW-F6163JL
2	C13, C14	Capacitor, film, 0.012 μ F, 800 V, \pm 3%, TH	Panasonic	ECW-H8123HA
2	C12, C32	Capacitor, ceramic, 0.1 μ F, 16 V, \pm 10%, X7R, 0603	Kemet	C0603C104K4RACTU
1	C15	Capacitor, film, 0.047 μ F, 630 V, \pm 20%, TH	Vishay-Bccomponents	BFC233820473
1	C16	Capacitor, ceramic, 1 μ F, 50 V, \pm 10%, X7R, 0603	Taiyo Yuden	UMK107AB7105KA-T
2	C17, C20	Capacitor, aluminum, 330 μ F, 16 V, \pm 20%, 0.014 Ω , TH	Nippon Chemi-Con	APS-160ELL331MJC5S
4	C21, C22, C23, C24	Capacitor, aluminum, 1000 μ F, 16 V, \pm 20%, 0.03 Ω , TH	Panasonic	EEU-FR1C102L
1	C25	Capacitor, ceramic, 1 μ F, 35 V, \pm 10%, X7R, 0805	Taiyo Yuden	GMK212B7105KG-T
1	C26	Capacitor, aluminum, 220 μ F, 35 V, \pm 20%, 0.087 Ω , TH	Nippon Chemi-Con	EKY-350ELL221MH15D
1	C29	Capacitor, ceramic, 0.047 μ F, 50 V, \pm 10%, X7R, 0805	AVX	08055C473KAT2A
2	C33, C39	Capacitor, ceramic, 0.1 μ F, 50 V, \pm 10%, X7R, 0603	AVX	06035C104KAT2A
2	C34, C35	Capacitor, ceramic, 10 μ F, 35 V, \pm 10%, X7R, 1206	Taiyo Yuden	GMK316AB7106KL
3	C36, C37, C38	Capacitor, ceramic, 470 pF, 50 V, \pm 10%, X7R, 0603	Kemet	C0603C471K5RACTU
1	C40	Capacitor, ceramic, 0.1 μ F, 25 V, \pm 10%, X7R, 0603	AVX	06033C104KAT2A
1	C41	Capacitor, ceramic, 1000 pF, 50 V, \pm 10%, X7R, 0603	Kemet	C0603C102K5RACTU
2	C43, C47	Capacitor, ceramic, 10 μ F, 50 V, \pm 10%, X5R, 1206_190	TDK	CGA5L3X5R1H106K160 AB
2	C44, C45	Capacitor, ceramic, 100 pF, 50 V, \pm 1%, C0G/NP0, 0603	AVX	06035A101FAT2A
1	C46	Capacitor, ceramic, 100 pF, 50 V, \pm 1%, C0G/NP0, 0603	AVX	06035A101FAT2A
1	C48	Capacitor, ceramic, 0.01 μ F, 50 V, \pm 10%, X7R, 0603	Kemet	C0603C103K5RACTU
0	C28	Capacitor, ceramic, 1000 pF, 25 V, \pm 5%, C0G/NP0, 0603	MuRata	GRM1885C1E102JA01D
0	C30	Capacitor, ceramic, 47 pF, 50V, \pm 5%, C0G/NP0, 0603	AVX	06035A470JAT2A
0	C31	Capacitor, aluminum, 10 μ F, 35V, \pm 20%, TH	Nichicon	UVR1V100MDD1TA
1	D1	Diode, switching-bridge, 600 V, 3 A, TH	Vishay-Semiconductor	1N5406
1	D2	Diode, switching-bridge, 420 V, 8 A, TH	Micro Commercial Components	GBU8J-BP
1	D3	Diode, Schottky, 600 V, 4 A, TH	Cree	C3D04060A
1	D4	Diode, P-N, 1000 V, 1 A, TH	Fairchild Semiconductor	IN4007
1	D10	Diode, Schottky, 40 V, 0.38 A, SOD-523	Diodes Inc.	ZLLS350TA

Table 5. UCC29950EVM-631 List of Materials (continued)

QTY	REF DES	DESCRIPTION	MFR	PART NUMBER
1	D6	Diode, ultrafast, 600 V, 1.5 A, SMA	Vishay-Semiconductor	BYG20J-E3/TR
2	D7, D8	Diode, Schottky, 45 V, 20 A, TH	ST Microelectronics	STPS40L45CT
1	D11	Diode, Zener, 18 V, 500 mW, SOD-123	Diodes Inc.	MMSZ5248B-7-F
2	D12, D13	Diode, switching, 100 V, 0.215 A, SOT-23	NXP Semiconductor	BAV99,215
1	D14	Diode, Zener, 12 V, 300 mW, SOD-323	NXP Semiconductor	BZX384-C12,115
2	D15, D16	Diode, fast rectifier, 800 V, 0.2 A, TVS, 1.7 mm x 0.7 mm x 1.25 mm	Panasonic	DA2JF8100L
1	D20	Diode, ultrafast, 75 V, 0.3 A, SOT-23	Diodes Inc.	BAS16-7-F
2	D5, D9, D18, D19	Diode, ultrafast, 100 V, 0.25 A, SOD-323	NXP Semiconductor	BAS316,115
1	F1	Fuse, 8 A, 250 V, TH	Littelfuse	0216008.MXESPP
9	H1, H2, H3, H4, H5, H6, H7, H8, H9	Machine screw, pan, phillips, M3 x 5 mm	Keystone	29311
8	H10, H11, H12, H13, H14, H15, H16, H17	Hex standoff #6-32 NYLON 1 inch x 1/2 inch	Keystone	4824
8	H18, H19, H20, H21, H22, H23, H24, H25	Standoff, Hex, 0.5 inch long #6-32 Nylon	Keystone	1903C
7	H29, H30, H31, H32, H33, H34, H35	MAX clip	Aavid Thermalloy	MAX01NG
3	HS1, HS2, HS3	Heatsink vert max clip, black, 4.25 inches	Aavid	782653B04250G
2	J1, J2	Terminal block 5.08 mm vertical 3 position, th	On-Shore Technology	ED120/3DS
1	J3	Terminal block, 4 x 1, 5.08 mm, TH	On-Shore Technology	ED120/4DS
1	J4	Header, TH, 100 mil, 1 x 3, gold plated, 230 mil above insulator	Sullins Connector Solutions	PBC03SAAN
1	J5	Terminal block 5.08mm vertical 2 position, th	On-Shore Technology	ED120/2DS
1	J6	Header (shrouded), 100 mil, 5 x 2, gold, TH	TE Connectivity	5103308-1
1	L1	Coupled inductor, 2.2 mH, 8 A, 0.014 Ω , \pm 30%, TH	Würth Elektronik eiSos	7448258022
1	L2	Inductor, ?, , A, TH	Renco Electronics	RLTI-1108
1	L3	Inductor, shielded, ?, 55 μ H, A, 0.065 Ω , TH	Vitec Corporation	75PR8106
1	L4	Inductor, shielded, powdered iron, 1.5 μ H, 31 A, 0.00162 Ω , SMD	Vishay-Dale	IHLP6767GZER1R5M11
1	LBL1	Thermal transfer printable labels, 0.65 inch wide x 0.20 inch high, - 10,000 per roll	Brady	THT-14-423-10
1	D17	LED, green, TH	Everlight	HLMP1523
3	Q1, Q2, Q3	MOSFET, N-channel, 650 V, 25 A, TO-262	AOS	AOW25S65
1	Q4	MOSFET, N-channel, 600 V, 0.021 A, SOT-23	Infineon Technologies	BSS126 H6906
1	R1	Resistor, 10.0 Ω , 1%, 0.25 W, 1206	Vishay-Dale	CRCW120610R0FKEA
2	R2, R3	Resistor, 3.3 Ω , 5%, 1 W, 2010	Vishay Dale	CRCW20103R30JNEF and CRCW20101R00JNEF
3	R4, R5, R6	Resistor, 0.1 Ω , 1%, 2 W, 2512	Stackpole Electronics Inc	CSRN2512FTR100

Table 5. UCC29950EVM-631 List of Materials (continued)

QTY	REF DES	DESCRIPTION	MFR	PART NUMBER
3	R7, R8, R9	Resistor, 1.20 Ω , 1%, 1 W, 2512	Panasonic Electronic Components	ERJ-1TRQF1R0U
2	R10, R17	Resistor, 3.30 Ω , 1%, 0.25 W, 1206	Panasonic	ERJ-8RQF3R3V
2	R11, R13	Resistor, 51.1 Ω , 1%, 0.25 W, 1206	Vishay-Dale	CRCW120651R1FKEA
5	R12, R18, R25, R41, R62	Resistor, 10.0 k Ω , 1%, 0.1 W, 0603	Vishay-Dale	CRCW060310K0FKEA
1	R14	Resistor, 10.0 M Ω , 1%, 0.1 W, 0603	Yageo America	RC0603FR-0710ML
1	R15	Resistor, 1.10 M Ω , 1%, 0.1 W, 0603	Vishay-Dale	CRCW06031M10FKEA
1	R22	Resistor, 5.10 k Ω , 0.5%, 0.1 W, 0805	Susumu Co Ltd	RR1220P-512-D
1	R24	Resistor, 49.9 Ω , 1%, 0.25 W, 1206	Panasonic	ERJ-8ENF49R9V
1	R26	Resistor, 18.0 k Ω , 1%, 0.1 W, 0603	Yageo America	RC0603FR-0718KL
1	R31	Resistor, 0 Ω , 5%, 0.125 W, 0805	Vishay-Dale	CRCW08050000Z0EA
1	R33	Trimmer, 10 k Ω , 0.75 W, TH	Bourns	3006P-1-103LF
4	R35, R36, R37, R48	Resistor, 0 Ω , 5%, 0.25 W, 1206	Vishay-Dale	CRCW12060000Z0EA
6	R38, R39, R40, R49, R50, R51	Resistor, 3.09 M Ω , 1%, 0.25 W, 1206	Vishay-Dale	CRCW12063M09FKEA
3	R42, R43, R44	Resistor, 10.0 M Ω , 1%, 0.25 W, 1206	Vishay-Dale	CRCW120610M0FKEA
1	R45	Resistor, 75.0 k Ω , 1%, 0.1 W, 0603	Vishay-Dale	CRCW060375K0FKEA
1	R46	Resistor, 3.3 M Ω , 5%, 0.1 W, 0603	Vishay-Dale	CRCW06033M30JNEA
3	R47, R54, R59	Resistor, 100 k Ω , 1%, 0.1 W, 0603	Vishay-Dale	CRCW0603100KFKEA
2	R52, R53	Resistor, 470 Ω , 1%, 0.1 W, 0603	Yageo America	RC0603FR-07470RL
1	R55	Resistor, 2.21 k Ω , 1%, 0.1 W, 0603	Vishay-Dale	CRCW06032K21FKEA
1	R56	Resistor, 3.32 k Ω , 1%, 0.1 W, 0603	Vishay-Dale	CRCW06033K32FKEA
1	R57	Resistor, 1.00 Ω , 1%, 0.125 W, 0805	Panasonic	ERJ-6RQF1R0V
1	R58	Resistor, 2.2 Ω , 5%, 0.125 W, 0805	Vishay-Dale	CRCW08052R20JNEA
1	R60	Resistor, 0 Ω , 5%, 0.25 W, 1206	Vishay-Dale	CRCW12060000Z0EA
0	R20, R32	Resistor, 5.10 k Ω , 1%, 0.1 W, 0603	Yageo America	RC0603FR-075K1L
0	R21	Resistor, 100 Ω , 1%, 0.1 W, 0603	Vishay-Dale	CRCW0603100RFKEA
0	R27	Resistor, 39.2 k Ω , 1%, 0.1 W, 0603	Vishay-Dale	CRCW060339K2FKEA
1	R16, R61	Resistor, 1.00 k Ω , 1%, 0.25 W, 1206	Vishay-Dale	CRCW12061K00FKEA
2	R19, R29, R30, R34	Resistor, 0 Ω , 5%, 0.1 W, 0603	Vishay-Dale	CRCW06030000Z0EA
1	R23, R28	Resistor, 1.20 k Ω , 1%, 0.1 W, 0603	Yageo America	RC0603FR-071K2L
1	RT1	Thermistor NTC, 5 Ω , 25%, Disc, 220 mm x 770 mm	GE Sensing	CL-40
2	SH1, SH2	Shunt, 100 mil, flash gold, black	Sullins Connector Solutions	SPC02SYAN
8	SIL1, SIL2, SIL3, SIL4, SIL5, SIL6, SIL7, SIL8	Silcon thermal pad	Bergquist Company	SP900S-0.009-00-114
2	S1, S2, S3	Switch, toggle, SPST, 1 position, TH	E-Switch	200USP9T1A1M2RE
1	T1	LLC transformer, 280 μ H, TH	Renco Electronics	RLTI-1115
2	TP1, TP4	Test point, multipurpose, yellow, TH	Keystone	5014

Table 5. UCC29950EVM-631 List of Materials (continued)

QTY	REF DES	DESCRIPTION	MFR	PART NUMBER
25	TP2, TP3, TP5, TP6, TP7, TP11, TP12, TP13, TP14, TP15, TP16, TP17, TP18, TP20, TP21, TP22, TP23, TP24, TP25, TP26, TP29, TP30, TP31, TP32, TP33	Test point, multipurpose, white, TH	Keystone	5012
3	TP8, TP10, TP28	Test point, compact, black, TH	Keystone	5006
1	TP9	Test point, compact, red, TH	Keystone	5005
1	TP19	Test point, multipurpose, red, TH	Keystone	5010
1	TP27	Test point, multipurpose, black, TH	Keystone	5011
1	U3, U4	Mini-flat half pitch package, general purpose photocoupler, SMT	Avago	ACPL-217-56AE
0	FID1, FID2, FID3	Fiducial mark. There is nothing to buy or mount.	N/A	N/A
1	PCB1	Printed Circuit Board	Any	UCC29950EVM-631
1	U1	4 A/8 A Single Channel High-Speed Low-Side Gate Drivers	TI	UCC27511DBV
1	U2	High-Speed Low-Side Gate Driver Device, D0014A	Texas Instruments	UCC27714D14
1	U5	Precision Programmable Reference, DBZ0003A	Texas Instruments	TL431AIDBZ
1	U6	Continuous-Conduction-Mode Power Factor Correction and LLC Resonant Converter Combo Controller, D0016A	Texas Instruments	UCC29950D
1	U7	Single Output LDO, 100 mA, Adjustable 1.2 to 18.5 V Output, 3 to 60 V Input, with Enable and Power Good, 8-pin MSOP (DGN), -40 to 125 degC, Green (RoHS & no Sb/Br)	Texas Instruments	TPS7A1601DGNT
1	V1	Varistor, 300 V, 1.75 kA, 7 MM radial, TH	EPCOS Inc	B72207S2301K101

Revision History

Changes from Original (March 2015) to A Revision	Page
• Added Line/Load Regulation images.....	21
• Added Power Factor image.....	21

NOTE: Page numbers for previous revisions may differ from page numbers in the current version.

STANDARD TERMS AND CONDITIONS FOR EVALUATION MODULES

1. *Delivery:* TI delivers TI evaluation boards, kits, or modules, including any accompanying demonstration software, components, or documentation (collectively, an "EVM" or "EVMs") to the User ("User") in accordance with the terms and conditions set forth herein. Acceptance of the EVM is expressly subject to the following terms and conditions.
 - 1.1 EVMs are intended solely for product or software developers for use in a research and development setting to facilitate feasibility evaluation, experimentation, or scientific analysis of TI semiconductors products. EVMs have no direct function and are not finished products. EVMs shall not be directly or indirectly assembled as a part or subassembly in any finished product. For clarification, any software or software tools provided with the EVM ("Software") shall not be subject to the terms and conditions set forth herein but rather shall be subject to the applicable terms and conditions that accompany such Software
 - 1.2 EVMs are not intended for consumer or household use. EVMs may not be sold, sublicensed, leased, rented, loaned, assigned, or otherwise distributed for commercial purposes by Users, in whole or in part, or used in any finished product or production system.
2. *Limited Warranty and Related Remedies/Disclaimers:*
 - 2.1 These terms and conditions do not apply to Software. The warranty, if any, for Software is covered in the applicable Software License Agreement.
 - 2.2 TI warrants that the TI EVM will conform to TI's published specifications for ninety (90) days after the date TI delivers such EVM to User. Notwithstanding the foregoing, TI shall not be liable for any defects that are caused by neglect, misuse or mistreatment by an entity other than TI, including improper installation or testing, or for any EVMs that have been altered or modified in any way by an entity other than TI. Moreover, TI shall not be liable for any defects that result from User's design, specifications or instructions for such EVMs. Testing and other quality control techniques are used to the extent TI deems necessary or as mandated by government requirements. TI does not test all parameters of each EVM.
 - 2.3 If any EVM fails to conform to the warranty set forth above, TI's sole liability shall be at its option to repair or replace such EVM, or credit User's account for such EVM. TI's liability under this warranty shall be limited to EVMs that are returned during the warranty period to the address designated by TI and that are determined by TI not to conform to such warranty. If TI elects to repair or replace such EVM, TI shall have a reasonable time to repair such EVM or provide replacements. Repaired EVMs shall be warranted for the remainder of the original warranty period. Replaced EVMs shall be warranted for a new full ninety (90) day warranty period.
3. *Regulatory Notices:*
 - 3.1 *United States*
 - 3.1.1 *Notice applicable to EVMs not FCC-Approved:*

This kit is designed to allow product developers to evaluate electronic components, circuitry, or software associated with the kit to determine whether to incorporate such items in a finished product and software developers to write software applications for use with the end product. This kit is not a finished product and when assembled may not be resold or otherwise marketed unless all required FCC equipment authorizations are first obtained. Operation is subject to the condition that this product not cause harmful interference to licensed radio stations and that this product accept harmful interference. Unless the assembled kit is designed to operate under part 15, part 18 or part 95 of this chapter, the operator of the kit must operate under the authority of an FCC license holder or must secure an experimental authorization under part 5 of this chapter.
 - 3.1.2 *For EVMs annotated as FCC – FEDERAL COMMUNICATIONS COMMISSION Part 15 Compliant:*

CAUTION

This device complies with part 15 of the FCC Rules. Operation is subject to the following two conditions: (1) This device may not cause harmful interference, and (2) this device must accept any interference received, including interference that may cause undesired operation.

Changes or modifications not expressly approved by the party responsible for compliance could void the user's authority to operate the equipment.

FCC Interference Statement for Class A EVM devices

NOTE: This equipment has been tested and found to comply with the limits for a Class A digital device, pursuant to part 15 of the FCC Rules. These limits are designed to provide reasonable protection against harmful interference when the equipment is operated in a commercial environment. This equipment generates, uses, and can radiate radio frequency energy and, if not installed and used in accordance with the instruction manual, may cause harmful interference to radio communications. Operation of this equipment in a residential area is likely to cause harmful interference in which case the user will be required to correct the interference at his own expense.

FCC Interference Statement for Class B EVM devices

NOTE: This equipment has been tested and found to comply with the limits for a Class B digital device, pursuant to part 15 of the FCC Rules. These limits are designed to provide reasonable protection against harmful interference in a residential installation. This equipment generates, uses and can radiate radio frequency energy and, if not installed and used in accordance with the instructions, may cause harmful interference to radio communications. However, there is no guarantee that interference will not occur in a particular installation. If this equipment does cause harmful interference to radio or television reception, which can be determined by turning the equipment off and on, the user is encouraged to try to correct the interference by one or more of the following measures:

- Reorient or relocate the receiving antenna.
- Increase the separation between the equipment and receiver.
- Connect the equipment into an outlet on a circuit different from that to which the receiver is connected.
- Consult the dealer or an experienced radio/TV technician for help.

3.2 Canada

3.2.1 For EVMs issued with an Industry Canada Certificate of Conformance to RSS-210

Concerning EVMs Including Radio Transmitters:

This device complies with Industry Canada license-exempt RSS standard(s). Operation is subject to the following two conditions: (1) this device may not cause interference, and (2) this device must accept any interference, including interference that may cause undesired operation of the device.

Concernant les EVMs avec appareils radio:

Le présent appareil est conforme aux CNR d'Industrie Canada applicables aux appareils radio exempts de licence. L'exploitation est autorisée aux deux conditions suivantes: (1) l'appareil ne doit pas produire de brouillage, et (2) l'utilisateur de l'appareil doit accepter tout brouillage radioélectrique subi, même si le brouillage est susceptible d'en compromettre le fonctionnement.

Concerning EVMs Including Detachable Antennas:

Under Industry Canada regulations, this radio transmitter may only operate using an antenna of a type and maximum (or lesser) gain approved for the transmitter by Industry Canada. To reduce potential radio interference to other users, the antenna type and its gain should be so chosen that the equivalent isotropically radiated power (e.i.r.p.) is not more than that necessary for successful communication. This radio transmitter has been approved by Industry Canada to operate with the antenna types listed in the user guide with the maximum permissible gain and required antenna impedance for each antenna type indicated. Antenna types not included in this list, having a gain greater than the maximum gain indicated for that type, are strictly prohibited for use with this device.

Concernant les EVMs avec antennes détachables

Conformément à la réglementation d'Industrie Canada, le présent émetteur radio peut fonctionner avec une antenne d'un type et d'un gain maximal (ou inférieur) approuvé pour l'émetteur par Industrie Canada. Dans le but de réduire les risques de brouillage radioélectrique à l'intention des autres utilisateurs, il faut choisir le type d'antenne et son gain de sorte que la puissance isotrope rayonnée équivalente (p.i.r.e.) ne dépasse pas l'intensité nécessaire à l'établissement d'une communication satisfaisante. Le présent émetteur radio a été approuvé par Industrie Canada pour fonctionner avec les types d'antenne énumérés dans le manuel d'usage et ayant un gain admissible maximal et l'impédance requise pour chaque type d'antenne. Les types d'antenne non inclus dans cette liste, ou dont le gain est supérieur au gain maximal indiqué, sont strictement interdits pour l'exploitation de l'émetteur.

3.3 Japan

3.3.1 *Notice for EVMs delivered in Japan:* Please see http://www.tij.co.jp/lstds/ti_ja/general/eStore/notice_01.page 日本国内に輸入される評価用キット、ボードについては、次のところをご覧ください。
http://www.tij.co.jp/lstds/ti_ja/general/eStore/notice_01.page

3.3.2 *Notice for Users of EVMs Considered "Radio Frequency Products" in Japan:* EVMs entering Japan may not be certified by TI as conforming to Technical Regulations of Radio Law of Japan.

If User uses EVMs in Japan, not certified to Technical Regulations of Radio Law of Japan, User is required by Radio Law of Japan to follow the instructions below with respect to EVMs:

1. Use EVMs in a shielded room or any other test facility as defined in the notification #173 issued by Ministry of Internal Affairs and Communications on March 28, 2006, based on Sub-section 1.1 of Article 6 of the Ministry's Rule for Enforcement of Radio Law of Japan,
2. Use EVMs only after User obtains the license of Test Radio Station as provided in Radio Law of Japan with respect to EVMs, or
3. Use of EVMs only after User obtains the Technical Regulations Conformity Certification as provided in Radio Law of Japan with respect to EVMs. Also, do not transfer EVMs, unless User gives the same notice above to the transferee. Please note that if User does not follow the instructions above, User will be subject to penalties of Radio Law of Japan.

【無線電波を送信する製品の開発キットをお使いになる際の注意事項】 開発キットの中には技術基準適合証明を受けていないものがあります。技術適合証明を受けていないものご使用に際しては、電波法遵守のため、以下のいずれかの措置を取っていただく必要がありますのでご注意ください。

1. 電波法施行規則第6条第1項第1号に基づく平成18年3月28日総務省告示第173号で定められた電波暗室等の試験設備でご使用いただく。
2. 実験局の免許を取得後ご使用いただく。
3. 技術基準適合証明を取得後ご使用いただく。

なお、本製品は、上記の「ご使用にあたっての注意」を譲渡先、移転先に通知しない限り、譲渡、移転できないものとします。

上記を遵守頂けない場合は、電波法の罰則が適用される可能性があることをご留意ください。日本テキサス・インスツルメンツ株式会社
東京都新宿区西新宿 6 丁目 2 4 番 1 号
西新宿三井ビル

3.3.3 *Notice for EVMs for Power Line Communication:* Please see http://www.tij.co.jp/llds/ti_ja/general/eStore/notice_02.page
電力線搬送波通信についての開発キットをお使いになる際の注意事項については、次のところをご覧ください。http://www.tij.co.jp/llds/ti_ja/general/eStore/notice_02.page

4 *EVM Use Restrictions and Warnings:*

4.1 EVMS ARE NOT FOR USE IN FUNCTIONAL SAFETY AND/OR SAFETY CRITICAL EVALUATIONS, INCLUDING BUT NOT LIMITED TO EVALUATIONS OF LIFE SUPPORT APPLICATIONS.

4.2 User must read and apply the user guide and other available documentation provided by TI regarding the EVM prior to handling or using the EVM, including without limitation any warning or restriction notices. The notices contain important safety information related to, for example, temperatures and voltages.

4.3 *Safety-Related Warnings and Restrictions:*

4.3.1 User shall operate the EVM within TI's recommended specifications and environmental considerations stated in the user guide, other available documentation provided by TI, and any other applicable requirements and employ reasonable and customary safeguards. Exceeding the specified performance ratings and specifications (including but not limited to input and output voltage, current, power, and environmental ranges) for the EVM may cause personal injury or death, or property damage. If there are questions concerning performance ratings and specifications, User should contact a TI field representative prior to connecting interface electronics including input power and intended loads. Any loads applied outside of the specified output range may also result in unintended and/or inaccurate operation and/or possible permanent damage to the EVM and/or interface electronics. Please consult the EVM user guide prior to connecting any load to the EVM output. If there is uncertainty as to the load specification, please contact a TI field representative. During normal operation, even with the inputs and outputs kept within the specified allowable ranges, some circuit components may have elevated case temperatures. These components include but are not limited to linear regulators, switching transistors, pass transistors, current sense resistors, and heat sinks, which can be identified using the information in the associated documentation. When working with the EVM, please be aware that the EVM may become very warm.

4.3.2 EVMs are intended solely for use by technically qualified, professional electronics experts who are familiar with the dangers and application risks associated with handling electrical mechanical components, systems, and subsystems. User assumes all responsibility and liability for proper and safe handling and use of the EVM by User or its employees, affiliates, contractors or designees. User assumes all responsibility and liability to ensure that any interfaces (electronic and/or mechanical) between the EVM and any human body are designed with suitable isolation and means to safely limit accessible leakage currents to minimize the risk of electrical shock hazard. User assumes all responsibility and liability for any improper or unsafe handling or use of the EVM by User or its employees, affiliates, contractors or designees.

4.4 User assumes all responsibility and liability to determine whether the EVM is subject to any applicable international, federal, state, or local laws and regulations related to User's handling and use of the EVM and, if applicable, User assumes all responsibility and liability for compliance in all respects with such laws and regulations. User assumes all responsibility and liability for proper disposal and recycling of the EVM consistent with all applicable international, federal, state, and local requirements.

5. *Accuracy of Information:* To the extent TI provides information on the availability and function of EVMs, TI attempts to be as accurate as possible. However, TI does not warrant the accuracy of EVM descriptions, EVM availability or other information on its websites as accurate, complete, reliable, current, or error-free.

6. *Disclaimers:*
- 6.1 EXCEPT AS SET FORTH ABOVE, EVMS AND ANY WRITTEN DESIGN MATERIALS PROVIDED WITH THE EVM (AND THE DESIGN OF THE EVM ITSELF) ARE PROVIDED "AS IS" AND "WITH ALL FAULTS." TI DISCLAIMS ALL OTHER WARRANTIES, EXPRESS OR IMPLIED, REGARDING SUCH ITEMS, INCLUDING BUT NOT LIMITED TO ANY IMPLIED WARRANTIES OF MERCHANTABILITY OR FITNESS FOR A PARTICULAR PURPOSE OR NON-INFRINGEMENT OF ANY THIRD PARTY PATENTS, COPYRIGHTS, TRADE SECRETS OR OTHER INTELLECTUAL PROPERTY RIGHTS.
- 6.2 EXCEPT FOR THE LIMITED RIGHT TO USE THE EVM SET FORTH HEREIN, NOTHING IN THESE TERMS AND CONDITIONS SHALL BE CONSTRUED AS GRANTING OR CONFERRING ANY RIGHTS BY LICENSE, PATENT, OR ANY OTHER INDUSTRIAL OR INTELLECTUAL PROPERTY RIGHT OF TI, ITS SUPPLIERS/LICENSORS OR ANY OTHER THIRD PARTY, TO USE THE EVM IN ANY FINISHED END-USER OR READY-TO-USE FINAL PRODUCT, OR FOR ANY INVENTION, DISCOVERY OR IMPROVEMENT MADE, CONCEIVED OR ACQUIRED PRIOR TO OR AFTER DELIVERY OF THE EVM.
7. *USER'S INDEMNITY OBLIGATIONS AND REPRESENTATIONS.* USER WILL DEFEND, INDEMNIFY AND HOLD TI, ITS LICENSORS AND THEIR REPRESENTATIVES HARMLESS FROM AND AGAINST ANY AND ALL CLAIMS, DAMAGES, LOSSES, EXPENSES, COSTS AND LIABILITIES (COLLECTIVELY, "CLAIMS") ARISING OUT OF OR IN CONNECTION WITH ANY HANDLING OR USE OF THE EVM THAT IS NOT IN ACCORDANCE WITH THESE TERMS AND CONDITIONS. THIS OBLIGATION SHALL APPLY WHETHER CLAIMS ARISE UNDER STATUTE, REGULATION, OR THE LAW OF TORT, CONTRACT OR ANY OTHER LEGAL THEORY, AND EVEN IF THE EVM FAILS TO PERFORM AS DESCRIBED OR EXPECTED.
8. *Limitations on Damages and Liability:*
- 8.1 *General Limitations.* IN NO EVENT SHALL TI BE LIABLE FOR ANY SPECIAL, COLLATERAL, INDIRECT, PUNITIVE, INCIDENTAL, CONSEQUENTIAL, OR EXEMPLARY DAMAGES IN CONNECTION WITH OR ARISING OUT OF THESE TERMS AND CONDITIONS OR THE USE OF THE EVMS PROVIDED HEREUNDER, REGARDLESS OF WHETHER TI HAS BEEN ADVISED OF THE POSSIBILITY OF SUCH DAMAGES. EXCLUDED DAMAGES INCLUDE, BUT ARE NOT LIMITED TO, COST OF REMOVAL OR REINSTALLATION, ANCILLARY COSTS TO THE PROCUREMENT OF SUBSTITUTE GOODS OR SERVICES, RETESTING, OUTSIDE COMPUTER TIME, LABOR COSTS, LOSS OF GOODWILL, LOSS OF PROFITS, LOSS OF SAVINGS, LOSS OF USE, LOSS OF DATA, OR BUSINESS INTERRUPTION. NO CLAIM, SUIT OR ACTION SHALL BE BROUGHT AGAINST TI MORE THAN ONE YEAR AFTER THE RELATED CAUSE OF ACTION HAS OCCURRED.
- 8.2 *Specific Limitations.* IN NO EVENT SHALL TI'S AGGREGATE LIABILITY FROM ANY WARRANTY OR OTHER OBLIGATION ARISING OUT OF OR IN CONNECTION WITH THESE TERMS AND CONDITIONS, OR ANY USE OF ANY TI EVM PROVIDED HEREUNDER, EXCEED THE TOTAL AMOUNT PAID TO TI FOR THE PARTICULAR UNITS SOLD UNDER THESE TERMS AND CONDITIONS WITH RESPECT TO WHICH LOSSES OR DAMAGES ARE CLAIMED. THE EXISTENCE OF MORE THAN ONE CLAIM AGAINST THE PARTICULAR UNITS SOLD TO USER UNDER THESE TERMS AND CONDITIONS SHALL NOT ENLARGE OR EXTEND THIS LIMIT.
9. *Return Policy.* Except as otherwise provided, TI does not offer any refunds, returns, or exchanges. Furthermore, no return of EVM(s) will be accepted if the package has been opened and no return of the EVM(s) will be accepted if they are damaged or otherwise not in a resalable condition. If User feels it has been incorrectly charged for the EVM(s) it ordered or that delivery violates the applicable order, User should contact TI. All refunds will be made in full within thirty (30) working days from the return of the components(s), excluding any postage or packaging costs.
10. *Governing Law:* These terms and conditions shall be governed by and interpreted in accordance with the laws of the State of Texas, without reference to conflict-of-laws principles. User agrees that non-exclusive jurisdiction for any dispute arising out of or relating to these terms and conditions lies within courts located in the State of Texas and consents to venue in Dallas County, Texas. Notwithstanding the foregoing, any judgment may be enforced in any United States or foreign court, and TI may seek injunctive relief in any United States or foreign court.

Mailing Address: Texas Instruments, Post Office Box 655303, Dallas, Texas 75265
Copyright © 2015, Texas Instruments Incorporated

IMPORTANT NOTICE

Texas Instruments Incorporated and its subsidiaries (TI) reserve the right to make corrections, enhancements, improvements and other changes to its semiconductor products and services per JESD46, latest issue, and to discontinue any product or service per JESD48, latest issue. Buyers should obtain the latest relevant information before placing orders and should verify that such information is current and complete. All semiconductor products (also referred to herein as "components") are sold subject to TI's terms and conditions of sale supplied at the time of order acknowledgment.

TI warrants performance of its components to the specifications applicable at the time of sale, in accordance with the warranty in TI's terms and conditions of sale of semiconductor products. Testing and other quality control techniques are used to the extent TI deems necessary to support this warranty. Except where mandated by applicable law, testing of all parameters of each component is not necessarily performed.

TI assumes no liability for applications assistance or the design of Buyers' products. Buyers are responsible for their products and applications using TI components. To minimize the risks associated with Buyers' products and applications, Buyers should provide adequate design and operating safeguards.

TI does not warrant or represent that any license, either express or implied, is granted under any patent right, copyright, mask work right, or other intellectual property right relating to any combination, machine, or process in which TI components or services are used. Information published by TI regarding third-party products or services does not constitute a license to use such products or services or a warranty or endorsement thereof. Use of such information may require a license from a third party under the patents or other intellectual property of the third party, or a license from TI under the patents or other intellectual property of TI.

Reproduction of significant portions of TI information in TI data books or data sheets is permissible only if reproduction is without alteration and is accompanied by all associated warranties, conditions, limitations, and notices. TI is not responsible or liable for such altered documentation. Information of third parties may be subject to additional restrictions.

Resale of TI components or services with statements different from or beyond the parameters stated by TI for that component or service voids all express and any implied warranties for the associated TI component or service and is an unfair and deceptive business practice. TI is not responsible or liable for any such statements.

Buyer acknowledges and agrees that it is solely responsible for compliance with all legal, regulatory and safety-related requirements concerning its products, and any use of TI components in its applications, notwithstanding any applications-related information or support that may be provided by TI. Buyer represents and agrees that it has all the necessary expertise to create and implement safeguards which anticipate dangerous consequences of failures, monitor failures and their consequences, lessen the likelihood of failures that might cause harm and take appropriate remedial actions. Buyer will fully indemnify TI and its representatives against any damages arising out of the use of any TI components in safety-critical applications.

In some cases, TI components may be promoted specifically to facilitate safety-related applications. With such components, TI's goal is to help enable customers to design and create their own end-product solutions that meet applicable functional safety standards and requirements. Nonetheless, such components are subject to these terms.

No TI components are authorized for use in FDA Class III (or similar life-critical medical equipment) unless authorized officers of the parties have executed a special agreement specifically governing such use.

Only those TI components which TI has specifically designated as military grade or "enhanced plastic" are designed and intended for use in military/aerospace applications or environments. Buyer acknowledges and agrees that any military or aerospace use of TI components which have **not** been so designated is solely at the Buyer's risk, and that Buyer is solely responsible for compliance with all legal and regulatory requirements in connection with such use.

TI has specifically designated certain components as meeting ISO/TS16949 requirements, mainly for automotive use. In any case of use of non-designated products, TI will not be responsible for any failure to meet ISO/TS16949.

Products

Audio	www.ti.com/audio
Amplifiers	amplifier.ti.com
Data Converters	dataconverter.ti.com
DLP® Products	www.dlp.com
DSP	dsp.ti.com
Clocks and Timers	www.ti.com/clocks
Interface	interface.ti.com
Logic	logic.ti.com
Power Mgmt	power.ti.com
Microcontrollers	microcontroller.ti.com
RFID	www.ti-rfid.com
OMAP Applications Processors	www.ti.com/omap
Wireless Connectivity	www.ti.com/wirelessconnectivity

Applications

Automotive and Transportation	www.ti.com/automotive
Communications and Telecom	www.ti.com/communications
Computers and Peripherals	www.ti.com/computers
Consumer Electronics	www.ti.com/consumer-apps
Energy and Lighting	www.ti.com/energy
Industrial	www.ti.com/industrial
Medical	www.ti.com/medical
Security	www.ti.com/security
Space, Avionics and Defense	www.ti.com/space-avionics-defense
Video and Imaging	www.ti.com/video

TI E2E Community

e2e.ti.com