

Peak Emission Wavelength: 1200nm

The MTSM1200MT2-BK consists of a 1200nm high output infrared die in a PLCC-2 black plastic molded surface mount package. Custom package solutions and sorting are available.

FEATURES

- > High Output Power
- > Wide Beam Angle
- > High Reliability

APPLICATIONS

- > Optical Switches & Sensors
- > Fiber Optical Communication
- > Bar-code Reader



Absolute Maximum Ratings (Ta=25°C)



ITEMS	SYMBOL	RATINGS	UNIT
Forward Current (DC)	IF	100	mA
Forward Current (Pulse)*1	IFP	1	A
Reverse Voltage	VR	5	V
Power Dissipation	PD	--	mW
Operating Temperature Range	ToPr	-20 ~ +80	°C
Storage Temperature Range	Tstg	-30 ~ +100	°C
Junction Temperature	Tj	100	°C
Lead Soldering Temperature	Tls	260	°C

*1: Tw=10μsec, T=10msec.

Electrical & Optical Characteristics (Ta = 25°C)

ITEMS	SYMBOL	CONDITIONS	MIN	TYP	MAX	UNIT
Power Output	PO	IF=20mA	--	2.2	--	mW
Power Output	PO	IF=50mA	--	4.6	--	mW
Forward Voltage	VF	IF=20mA	--	1.00	--	V
Forward Voltage	VF	IF=50mA	--	1.06	--	V
Reverse Current	IR	VR=5V	--	--	100	μA
Peak Emission Wavelength	λp	IF=50mA	--	1200	--	nm
Spectral Line Half Width	Δλ	IF=50mA	--	63	--	nm
Half Intensity Beam Angle	Θ	IF=50mA	--	±55	--	deg

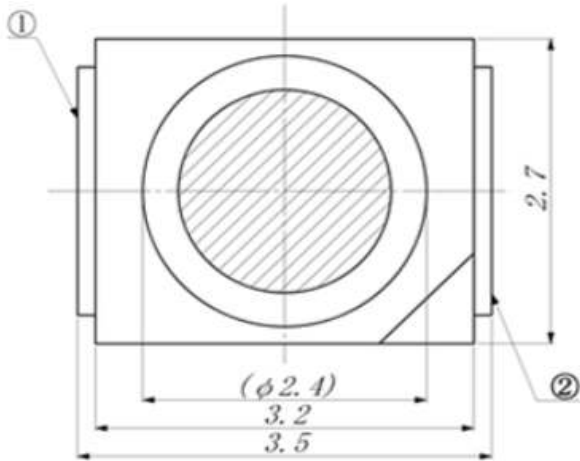

① Cathode ② Anode

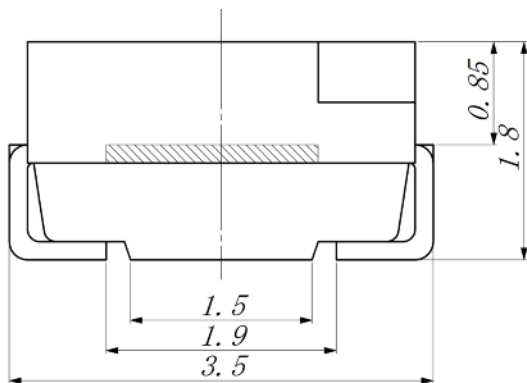
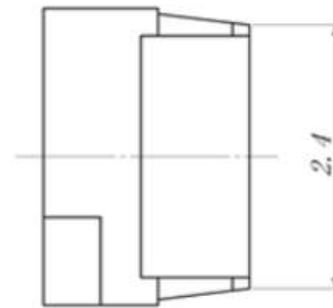

SPECTRAL OUTPUT

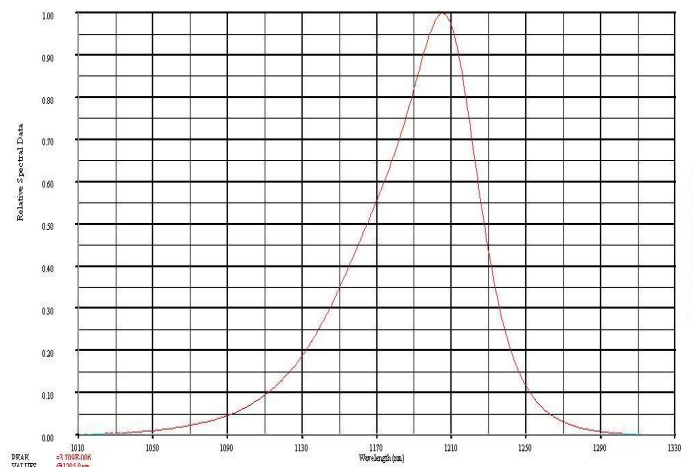

Unit: mm, Tolerance: ± 0.2

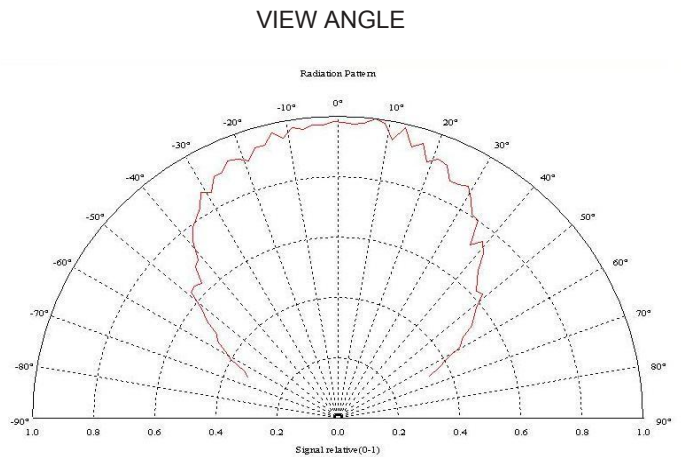
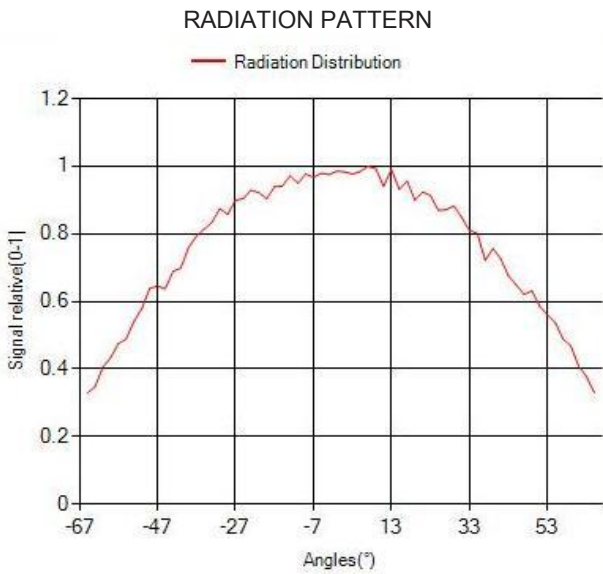
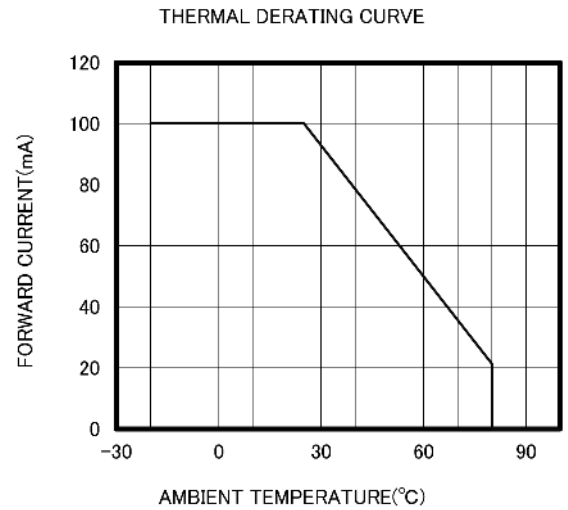
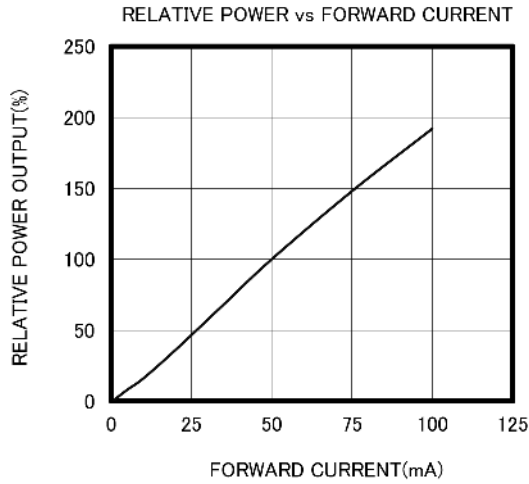

The information contained herein is subject to change without notice.

2020-04-30

FORWARD I-V CHARACTERISTICS

