

## 36 Gbps, 4:1 MUX WITH DUTY CYCLE CONTROL & PROGRAMMABLE OUTPUT VOLTAGE

### Typical Applications

The HMC847LC5 is ideal for:

- SONET OC-768
- RF ATE Applications
- Broadband Test & Measurements
- Serial Data Transmission up to 36 Gbps
- High Speed DAC Interfacing

### Features

- Supports Data Rates up to 36 Gbps
- Half Rate Clock Input
- Quarter Rate Reference Clock Output
- Fast Rise and Fall Times: 11 / 12 ps
- Programmable Differential Output  
Voltage Swing: 250 - 900 mVp-p
- Single Supply: +3.3V
- 32 Lead Ceramic 5x5 mm SMT Package: 25 mm<sup>2</sup>

### Functional Diagram

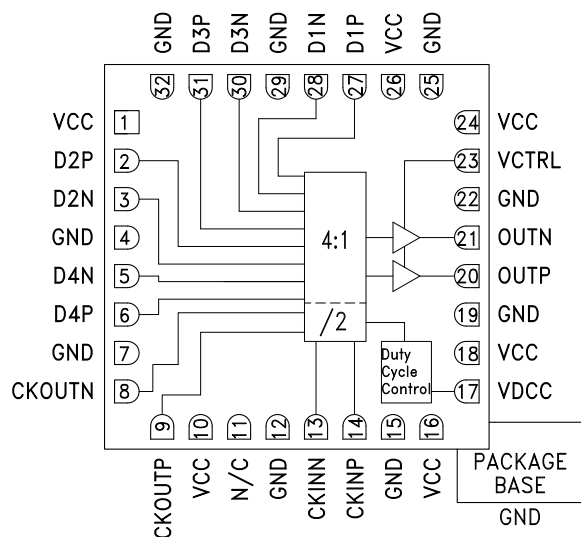

### General Description

The HMC847LC5 is a 4:1 multiplexer for operation at output data rate up to 36 Gbps. The mux latches the four differential inputs on falling edge of the input clock CKIN (See timing diagram on page.6). The device uses both rising and falling edges of the half-rate clock to serialize the data. A quarter-rate clock output, which is synchronous to the data output of HMC847LC5, is generated on chip.

All clock and data inputs / outputs of the HMC847LC5 are CML and terminated on-chip with 50 Ohms to the, VCC, and may be DC or AC coupled. The inputs and outputs of the HMC847LC5 may be operated either differentially or single-ended. The HMC847LC5 also features an output level control pin, VCTRL, which allows for loss compensation or signal level optimization. The VDCC pin controls the data output cross-point & duty cycle. The HMC847LC5 operates from a single +3.3V supply and is available in ROHS compliant 5x5 mm SMT package.

### Electrical Specifications, $T_A = +25^\circ\text{C}$ , $V_{cc} = +3.3\text{V}$

Parameter	Conditions	Min.	Typ.	Max	Units
Power Supply Voltage	$\pm 5\%$ Tolerance	3.13	3.3	3.47	V
Power Supply Current	Vctrl = 2.5V	480	530	580	mA
Output Amplitude Control Voltage Range (Vctrl)		1.7	2.5	3	V
Data Output Voltage Swing Range	Differential, peak-to-peak @ 36 Gbps	550		900	mVp-p
Duty Cycle Control Voltage Range (Vdccc)	Vdccc = 1.6V for 50% duty cycle	1	1.6	2	V
Duty Cycle Control Range	@ 36 Gbps	40	50	60	%
Clock Output Voltage Swing	Differential, peak-to-peak @ 10 GHz	480	580	680	mVp-p
Maximum Data Rate				36	Gbps
Maximum Clock Rate	Half Rate Clock			18	GHz

## 36 Gbps, 4:1 MUX WITH DUTY CYCLE CONTROL & PROGRAMMABLE OUTPUT VOLTAGE

### Electrical Specifications, (continued)

Parameter	Conditions	Min.	Typ.	Max	Units
Data Rate Range [1]		DC		36	Gbps
	$V_{CC} \geq 3.3V, T_A \leq 25$	DC		40	Gbps
Input Amplitude (Data)	Single-Ended, peak-to-peak [2]	150		800	mVp-p
	Differential, peak-to-peak	150		1000	mVp-p
Input Amplitude (Clock)	Single-Ended, peak-to-peak [2]	100		700	mVp-p
	Differential, peak-to-peak	100		1000	mVp-p
Input High Voltage (Data & Clock)	$V_{ctrl} = 2.5V$	2.8		3.8	V
Input Low Voltage (Data & Clock)	$V_{ctrl} = 2.5V$	2.3		3.3	V
Output High Voltage	$V_{ctrl} = 2.5V$		2.94		V
Output Low Voltage	$V_{ctrl} = 2.5V$		2.62		V
Input Return Loss	Data input up to 10 GHz		-10		dB
	Clock input up to 36 GHz		-12		dB
Output Return Loss	Data output up to 28 GHz		-10		dB
	Clock output up to 36 GHz		-5		dB
Deterministic Jitter, $J_d$ [3]			3.5		ps p-p
Additive Random Jitter, $J_r$ [4]			0.75		ps rms
Rise Time, $t_r$ [3]	20% - 80%		13		ps
Fall Time, $t_f$ [3]	20% - 80%		13		ps
Propagation Delay Clock to Clock, $T_{cdp}$	Input clock to output clock		107		ps
Propagation Delay Clock to Data, $T_{dpd}$	Input clock to output data		125+2.5 CLKIN period		ps
Set Up Time, $t_s$	Falling edge of CKIN to $t_{sample}$ at center of DIN1-4 time		-80		ps
Hold Time, $t_h$	Falling edge of CKIN to $t_{sample}$ at center of DIN1-4 time		90		ps

[1] Low frequency operation depends on AC coupling.

[2] The un-used port is biased @ 3.3V

[3] CKINP: 18 GHz clock signal, 300 mVp-p single-ended, D1P-D4P: 9 Gbps PRBS  $2^{31}-1$  pattern, 300 mVp-p single-ended

[4] Random jitter is measured with 36 Gbps PRBS31 pattern

### DC Current vs. Supply Voltage [1] [2]

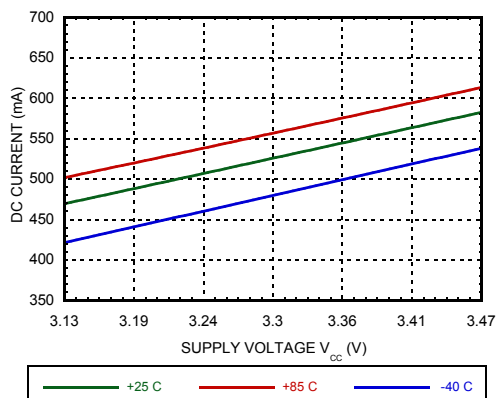

### Differential Output Swing vs. Supply Voltage [1][2]

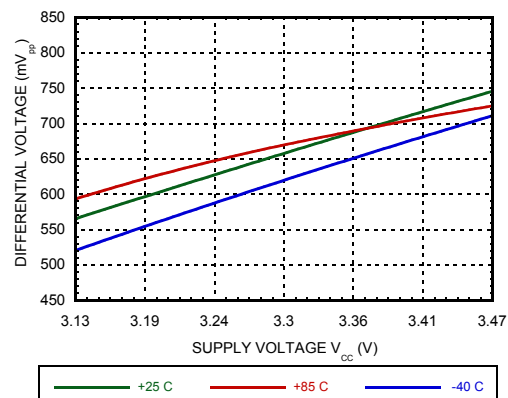

[1]  $V_{ctrl} = 2.5V$

[2] Data Rate = 36 Gbps

v06.1215

**36 Gbps, 4:1 MUX WITH DUTY CYCLE CONTROL & PROGRAMMABLE OUTPUT VOLTAGE**

**DC Current vs. Vctrl [1]**

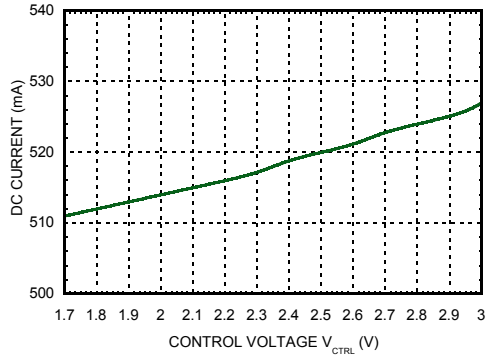

**Differential Output Swing vs. Vctrl [1]**

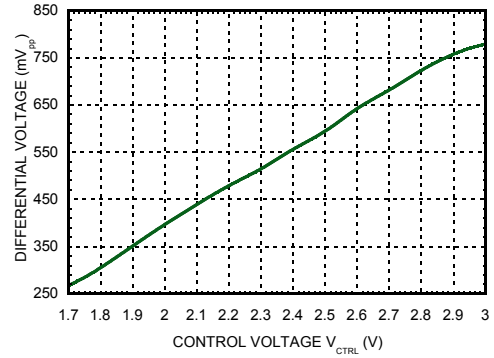

**Rise Time vs. Supply Voltage [1][2][3][4]**

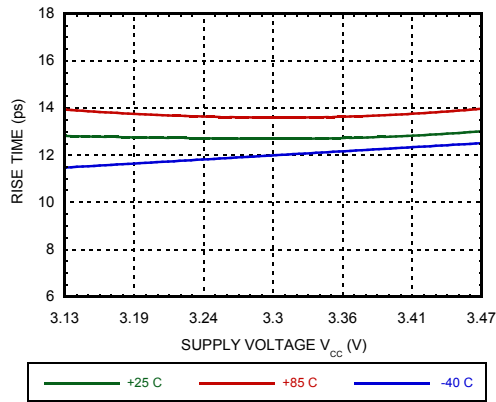

**Fall Time vs. Supply Voltage [1][2][3][4]**

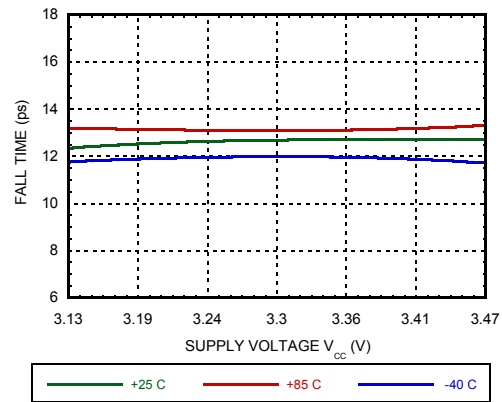

**Peak-to-Peak Jitter vs. Supply Voltage [1][2][3][5]**

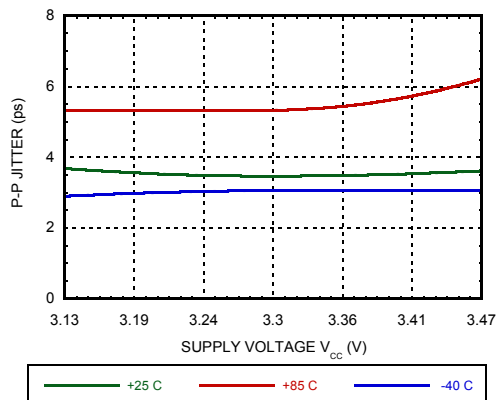

**RMS Jitter vs. Supply Voltage [1][2][3][5]**

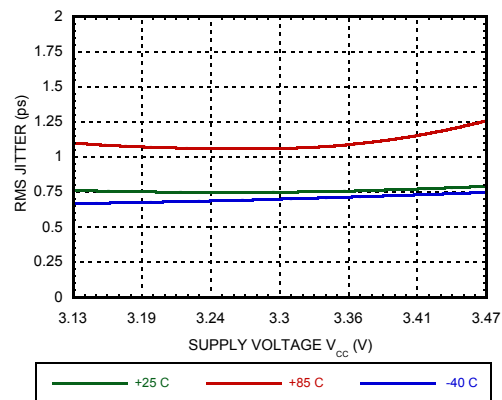

[1] Data Rate = 36 Gbps [2] Vctrl = 2.5V [3] Data was taken at single-ended output [4] 20% - 80%  
 [5] Source jitter was not deembedded

v06.1215

**36 Gbps, 4:1 MUX WITH DUTY CYCLE CONTROL & PROGRAMMABLE OUTPUT VOLTAGE**

**Data Input Return Loss vs. Frequency [1][2]**

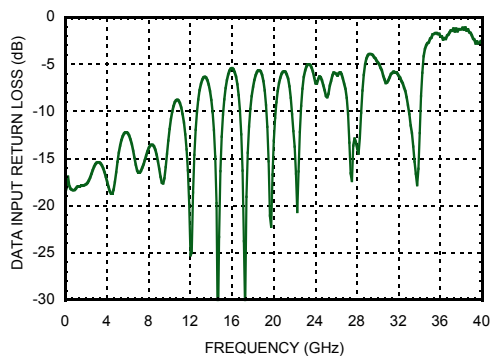

**Data Output Return Loss vs. Frequency [1][2]**

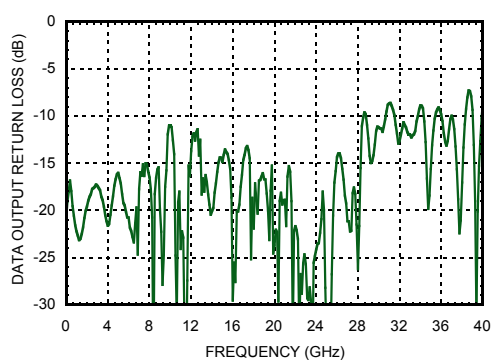

**Clock Input Return Loss vs. Frequency [1][2]**

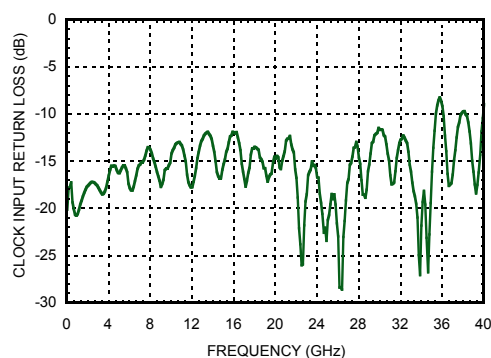

**Clock Output Return Loss vs. Frequency [1][2]**

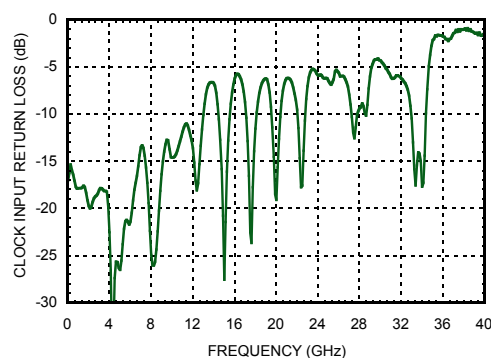

**40 Gbps Single-Ended Output Eye Diagram**

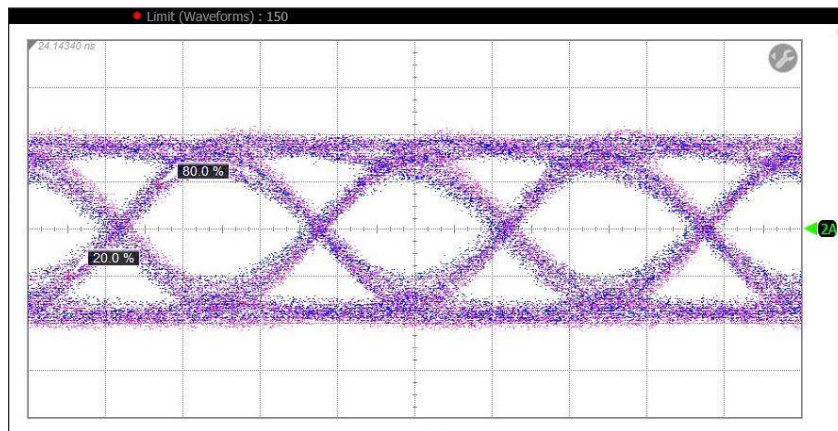

Measurement Results					
	Eye Amp (mVpp)	P-P Jitter (ps)	RMS Jitter (ps)	Rise Time (ps)	Fall Time (ps)
HSP	308	4.8	1.1	11.6	14.4
HSN	328	3.07	0.74	12.4	13.9

Time Scale: 10 ps/div ; Amplitude Scale: 100 mV/div

Test Conditions: VCC = +3.3V, VCTRL = 2.5V; D1P-D4P: 10 Gbps NRZ PRBS 2<sup>31</sup>-1 pattern, 300 mVp-p single-ended

CKINP: 20 GHz Clock Signal, 300 mVp-p single-ended

[1] Vctrl = 2.6V

[2] Device measured on evaluation board with single ended time domain gating

v06.1215

**36 Gbps, 4:1 MUX WITH DUTY CYCLE CONTROL  
& PROGRAMMABLE OUTPUT VOLTAGE**

**36Gbps Single-Ended Output Eye Diagram**

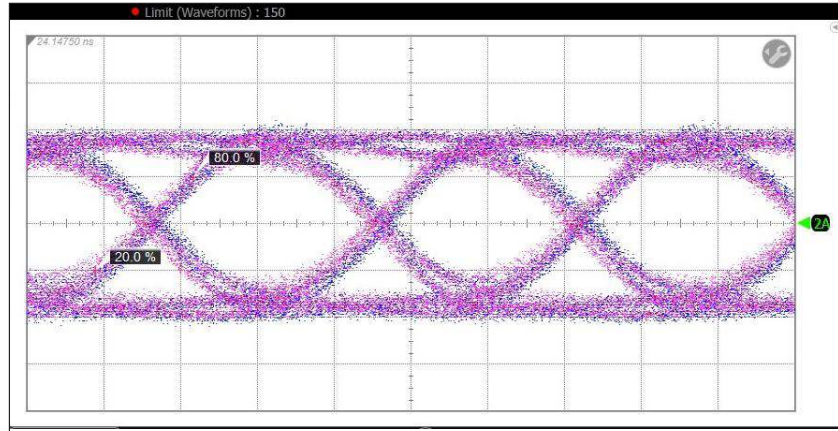

Measurement Results					
	Eye Amp (mVpp)	P-P Jitter (ps)	RMS Jitter (ps)	Rise Time (ps)	Fall Time (ps)
HSP	320	4.27	1.03	12.7	13.5
HSN	338	3.33	0.65	12.7	12.7

Time Scale: 10 ps/div ; Amplitude Scale: 100 mV/div  
 Test Conditions: VCC = +3.3V, VCTRL = 2.5V; D1P-D4P: 9 Gbps NRZ PRBS 2<sup>31</sup>-1 pattern, 300 mVp-p single-ended  
 CKINP: 18 GHz Clock Signal, 300 mVp-p single-ended

**20 Gbps Single-Ended Output Eye Diagram**

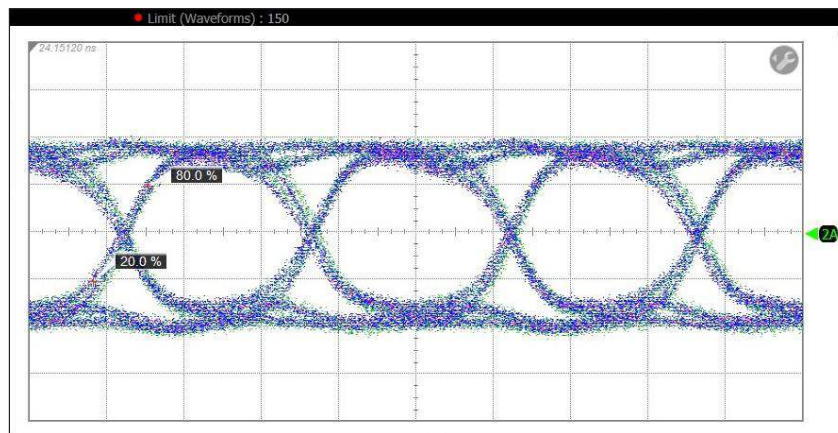

Measurement Results					
	Eye Amp (mVpp)	P-P Jitter (ps)	RMS Jitter (ps)	Rise Time (ps)	Fall Time (ps)
HSP	336	2.93	0.91	14.2	15.8
HSN	352	2.13	0.73	13	14.4

Time Scale: 20 ps/div ; Amplitude Scale: 100 mV/div  
 Test Conditions: VCC = +3.3V, VCTRL = 2.5V; D1P-D4P: 5 Gbps NRZ PRBS 2<sup>31</sup>-1 pattern, 300 mVp-p single-ended  
 CKINP: 10 GHz Clock Signal, 300 mVp-p single-ended

v06.1215

**36 Gbps, 4:1 MUX WITH DUTY CYCLE CONTROL  
& PROGRAMMABLE OUTPUT VOLTAGE**

**Timing Diagram**

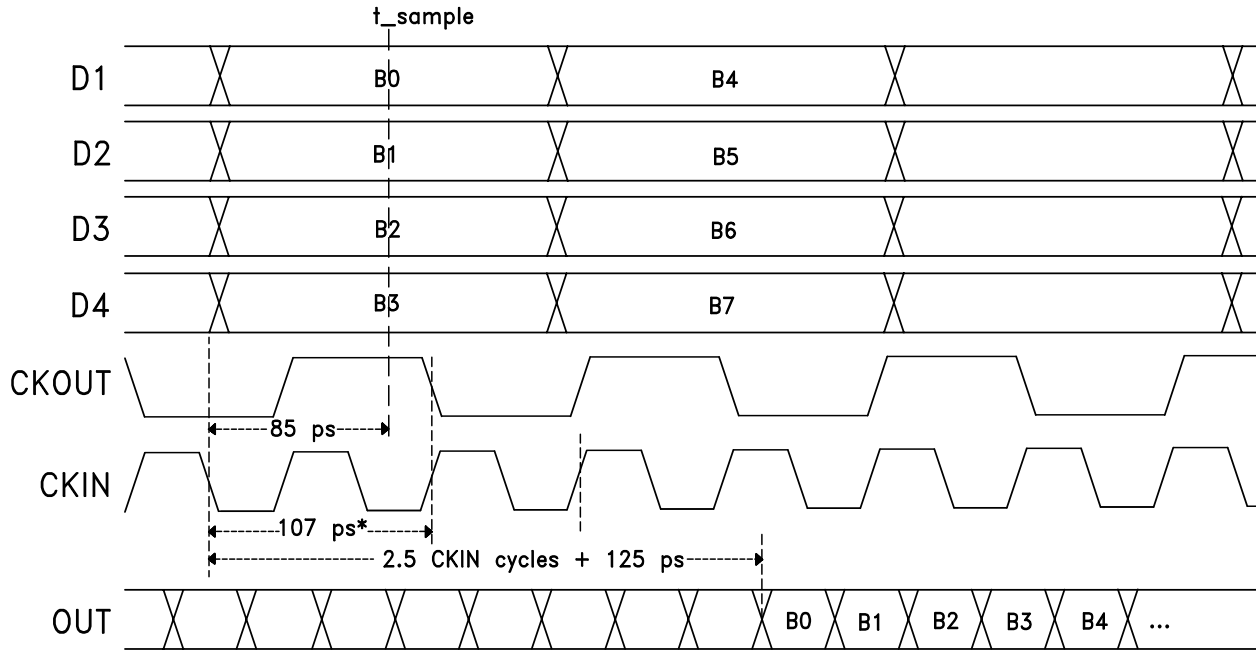

\* To either rising or falling edge of CKOUT

v06.1215

## 36 Gbps, 4:1 MUX WITH DUTY CYCLE CONTROL & PROGRAMMABLE OUTPUT VOLTAGE

### Absolute Maximum Ratings

Power Supply Voltage (Vcc)	+0.5V to +3.7V
Input Voltages	Vcc -2V to Vcc +0.5V
DC Control Pins (Vctrl, Vdcc)	Vcc +0.2V to Vcc -2.5V
Channel Temperature	125 °C
Continuous Pdiss (T = 85 °C) (derate 50.91 mW/°C above 85 °C)	2.04 W
Thermal Resistance (Channel to die bottom)	19.64 °C/W
Storage Temperature	-65°C to +150°C
Operating Temperature	-40°C to +85°C
ESD Level (HBM)	Class 1B



ELECTROSTATIC SENSITIVE DEVICE  
OBSERVE HANDLING PRECAUTIONS

### Outline Drawing

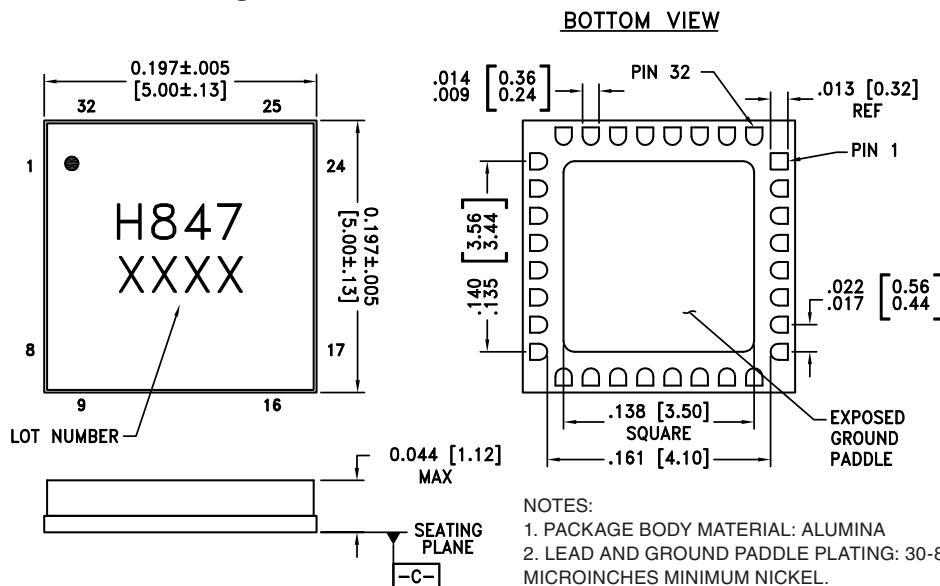

NOTES:

1. PACKAGE BODY MATERIAL: ALUMINA
2. LEAD AND GROUND PADDLE PLATING: 30-80 MICROINCHES GOLD OVER 50 MICROINCHES MINIMUM NICKEL.
3. DIMENSIONS ARE IN INCHES [MILLIMETERS].
4. LEAD SPACING TOLERANCE IS NON-CUMULATIVE.
5. CHARACTERS TO BE BLACK INK MARKED WITH .018"MIN to .030"MAX HEIGHT REQUIREMENTS. UTILIZE MAXIMUM CHARACTER HEIGHT BASED ON LID DIMENSIONS AND BEST FIT. LOCATE APPROX. AS SHOWN.
6. PACKAGE WARP SHALL NOT EXCEED 0.05mm DATUM -C-
7. ALL GROUND LEADS AND GROUND PADDLE MUST BE SOLDERED TO PCB RF GROUND.

### Package Information

Part Number	Package Body Material	Lead Finish	MSL Rating <sup>[2]</sup>	Package Marking <sup>[1]</sup>
HMC847LC5	Alumina, White	Gold over Nickel	MSL3	H847 XXXX

[1] 4-Digit lot number XXXX

[2] Max peak reflow temperature of 260 °C



**36 Gbps, 4:1 MUX WITH DUTY CYCLE CONTROL  
& PROGRAMMABLE OUTPUT VOLTAGE**
**Pin Descriptions**

Pin Number	Function	Description	Interface Schematic
1, 10, 16, 18, 24, 26	VCC	Power Supply (3.3V)	
2, 3, 5, 6, 27, 28, 30, 31	D2P, D2N, D4N, D4P, D1P, D1N, D3N, D3P	Differential 4 Channel Serial Data Inputs.	
4, 7, 12, 15, 19, 22, 25, 29, 32	GND	Signal and supply ground	
8, 9	CKOUTN, CKOUTP	Differential Quarter Rate System Clock Outputs.	
11	N/C	Not connected.	
13, 14	CKINN, CKINP	Differential Half Rate Clock Inputs.	
17	Vdcc	Output Duty Cycle Correction Control	
20, 21	OUTP, OUTN	Differential High Speed Serial Data Outputs	



v06.1215

**36 Gbps, 4:1 MUX WITH DUTY CYCLE CONTROL  
& PROGRAMMABLE OUTPUT VOLTAGE**

**Pin Descriptions** (Continued)

Pin Number	Function	Description	Interface Schematic
23	Vctrl	Output Amplitude Control	

**36 Gbps, 4:1 MUX WITH DUTY CYCLE CONTROL & PROGRAMMABLE OUTPUT VOLTAGE**

**Evaluation PCB**

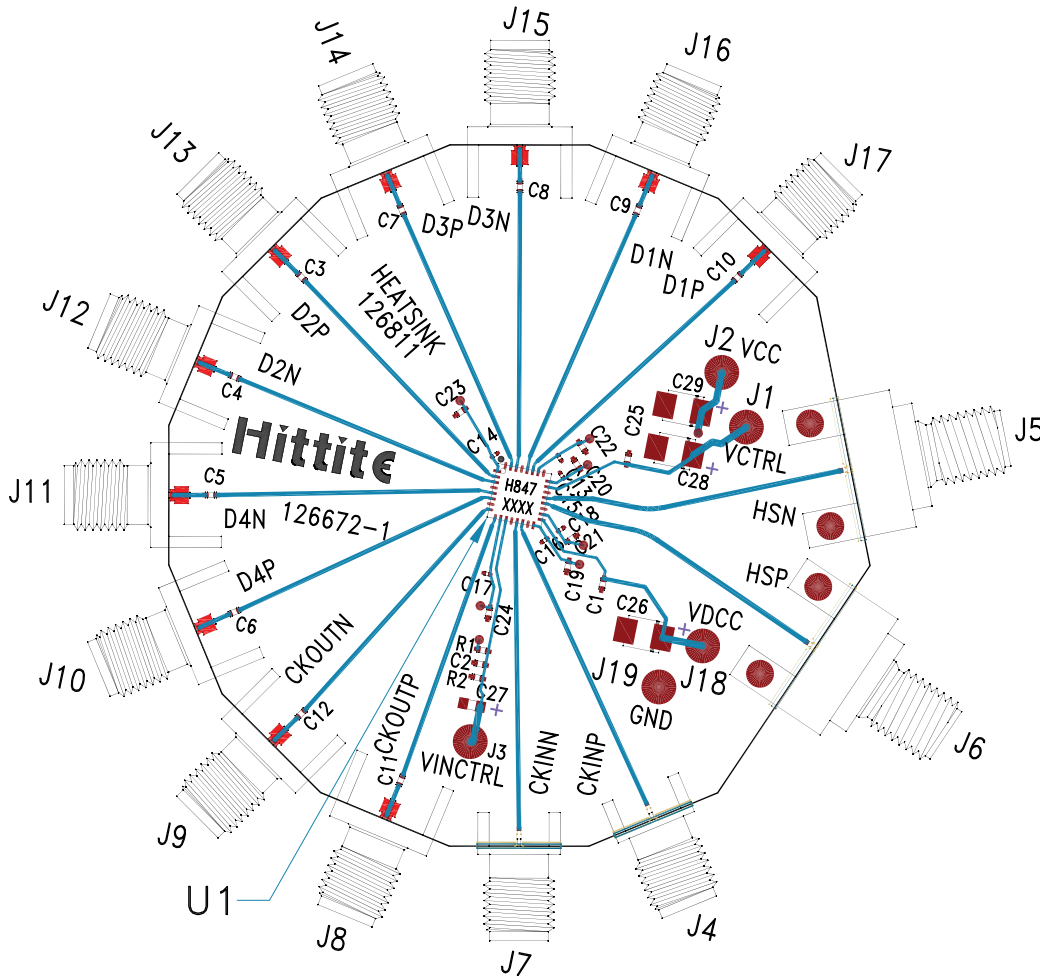

**List of Materials for Evaluation PCB 126674 [1]**

Item	Description
J1, J2, J18, J19	DC Connector
J4, J7	K Connector
J5, J6	2.4mm Connector
J8 - J17	SMA Connector
C1, C19 - C25	100 nF Capacitor, 0402 Pkg.
C3 - C12	10 nF Capacitor, 0402 Pkg.
C13 - C18	1 nF Capacitor, 0201 Pkg.
C26, C28, C29	4.7 µF Capacitor, Tantalum
U1	HMC847LC5 36 Gbps 4:1 Mux
PCB [2]	126672 Evaluation Board

[1] Reference this number when ordering complete evaluation PCB

[2] Circuit Board Material: Arlon 25FR or Rogers 4350

The circuit board used in the application should use RF circuit design techniques. Signal lines should have 50 Ohm impedance while the package ground leads should be connected directly to the ground plane similar to that shown. The exposed metal package base must be connected to GND. A sufficient number of via holes should be used to connect the top and bottom ground planes. The evaluation circuit board shown is available from Hittite upon request.

v06.1215

**36 Gbps, 4:1 MUX WITH DUTY CYCLE CONTROL & PROGRAMMABLE OUTPUT VOLTAGE**

**Application Circuit**

